

FLUKE®

5320A

Multifunction Electrical Tester Calibrator

Users Manual

September 2006, Rev. 2, 10/08

© 2006, 2007, 2008 Fluke Corporation. All rights reserved. Specifications subject to change without notice.
All product names are trademarks of their respective companies.

LIMITED WARRANTY AND LIMITATION OF LIABILITY

Each Fluke product is warranted to be free from defects in material and workmanship under normal use and service. The warranty period is one year and begins on the date of shipment. Parts, product repairs, and services are warranted for 90 days. This warranty extends only to the original buyer or end-user customer of a Fluke authorized reseller, and does not apply to fuses, disposable batteries, or to any product which, in Fluke's opinion, has been misused, altered, neglected, contaminated, or damaged by accident or abnormal conditions of operation or handling. Fluke warrants that software will operate substantially in accordance with its functional specifications for 90 days and that it has been properly recorded on non-defective media. Fluke does not warrant that software will be error free or operate without interruption.

Fluke authorized resellers shall extend this warranty on new and unused products to end-user customers only but have no authority to extend a greater or different warranty on behalf of Fluke. Warranty support is available only if product is purchased through a Fluke authorized sales outlet or Buyer has paid the applicable international price. Fluke reserves the right to invoice Buyer for importation costs of repair/replacement parts when product purchased in one country is submitted for repair in another country.

Fluke's warranty obligation is limited, at Fluke's option, to refund of the purchase price, free of charge repair, or replacement of a defective product which is returned to a Fluke authorized service center within the warranty period.

To obtain warranty service, contact your nearest Fluke authorized service center to obtain return authorization information, then send the product to that service center, with a description of the difficulty, postage and insurance prepaid (FOB Destination). Fluke assumes no risk for damage in transit. Following warranty repair, the product will be returned to Buyer, transportation prepaid (FOB Destination). If Fluke determines that failure was caused by neglect, misuse, contamination, alteration, accident, or abnormal condition of operation or handling, including overvoltage failures caused by use outside the product's specified rating, or normal wear and tear of mechanical components, Fluke will provide an estimate of repair costs and obtain authorization before commencing the work. Following repair, the product will be returned to the Buyer transportation prepaid and the Buyer will be billed for the repair and return transportation charges (FOB Shipping Point).

THIS WARRANTY IS BUYER'S SOLE AND EXCLUSIVE REMEDY AND IS IN LIEU OF ALL OTHER WARRANTIES, EXPRESS OR IMPLIED, INCLUDING BUT NOT LIMITED TO ANY IMPLIED WARRANTY OF MERCHANTABILITY OR FITNESS FOR A PARTICULAR PURPOSE. FLUKE SHALL NOT BE LIABLE FOR ANY SPECIAL, INDIRECT, INCIDENTAL, OR CONSEQUENTIAL DAMAGES OR LOSSES, INCLUDING LOSS OF DATA, ARISING FROM ANY CAUSE OR THEORY.

Since some countries or states do not allow limitation of the term of an implied warranty, or exclusion or limitation of incidental or consequential damages, the limitations and exclusions of this warranty may not apply to every buyer. If any provision of this Warranty is held invalid or unenforceable by a court or other decision-maker of competent jurisdiction, such holding will not affect the validity or enforceability of any other provision.

Fluke Corporation
P.O. Box 9090
Everett, WA 98206-9090
U.S.A.

Fluke Europe B.V.
P.O. Box 1186
5602 BD Eindhoven
The Netherlands

11/99

To register your product online, visit register.fluke.com

Claims

Immediately upon arrival, purchaser shall check the packing container against the enclosed packing list and shall, within thirty (30) days of arrival, give Fluke notice of shortages or any nonconformity with the terms of the order. If purchaser fails to give notice, the delivery shall be deemed to conform with the terms of the order.

The purchaser assumes all risk of loss or damage to instruments upon delivery by Fluke to the carrier. If an instrument is damaged in transit, PURCHASER MUST FILE ALL CLAIMS FOR DAMAGE WITH THE CARRIER to obtain compensation. Upon request by purchaser, Fluke will submit an estimate of the cost to repair shipment damage.

Fluke will be happy to answer all questions to enhance the use of this instrument. Please address your requests or correspondence to: Fluke Corporation, P.O. Box 9090, Everett, WA 98206-9090.

Declaration of the Manufacturer or Importer

We hereby certify that the Fluke Model 5320A is in compliance with Postal Regulation Vfg. 1046 and is RFI suppressed. The marketing and sale of the equipment was reported to the German Postal Service. The right to retest this equipment to verify compliance with the regulation was given to the German Postal Service.

Bescheinigung des Herstellers/Importeurs

Hiermit wird bescheinigt, daß Fluke Models 5320A in Übereinstimmung mit den Bestimmungen der Amtsblattverfügung Vfg. 1046 funk-entstört ist, Der Deutschen Bundespost wurde das Inverkehrbringen dieses Gerätes angezeigt und die Berechtigung zur Überprüfung der Seire auf Einhaltung der Bestimmungen eingeräumt.

Fluke Corporation

Interference Information

This equipment generates and uses radio frequency energy and, if not installed and used in strict accordance with the manufacturer's instructions, may cause interference to radio and television reception. It has been type-tested and found to comply with the limits for a Class B computing device in accordance with the specifications in Subpart J of Part 15 of FCC Rules, which are designed to provide reasonable protection against such interference in a residential installation. However, there is no guarantee that interference will not occur in a particular installation. If this equipment does cause interference to radio or television reception, which can be determined by turning the equipment off and on, the user is encouraged to try to correct the interference by one of more of the following measures:

- Reorient the receiving antenna
- Relocate the equipment with respect to the receiver
- Move the equipment away from the receiver
- Plug the equipment into a different outlet so that the computer and receiver are on different branch circuits

If necessary, the user should consult the dealer or an experienced radio/television technician for additional suggestions. The user may find the following booklet prepared by the Federal Communications Commission helpful: How to Identify and Resolve Radio-TV Interference Problems. This booklet is available from the U.S. Government Printing Office, Washington, D.C. 20402. Stock No. 004-000-00345-4.

OPERATOR SAFETY SUMMARY

WARNING

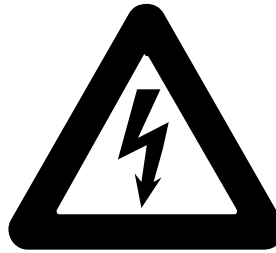

HIGH VOLTAGE

is used in the operation of this equipment

LETHAL VOLTAGE

may be present on the terminals, observe all safety precautions!

To avoid electrical shock hazard, the operator should not electrically contact the output HI, SENSE HI, or the Impedance and RCD binding posts. During operation, lethal voltages of up to 1100V ac or dc may be present on these terminals.

Whenever the nature of the operation permits, keep one hand away from equipment to reduce the hazard of current flowing through vital organs of the body.

Terms in this Manual

This instrument has been designed and tested in accordance with the safety standards listed in the General Specifications. This manual contains information and warnings which have to be followed by the user to ensure safe operation and to retain the instrument in safe condition.

⚠ **WARNING** statements identify conditions or practices that could result in personal injury or loss of life.

⚠ **CAUTION** statements identify conditions or practices that could result in damage to the equipment or other property.

Symbols Marked on Equipment



DANGER — High Voltage, risk of electric shock



Protective ground (earth) terminal



Attention — refer to the manual. This symbol indicates that information about the usage of a feature is contained in the manual.

Power Source

The 5320A is intended to operate from a power source that will not apply more than 264 V ac rms between the supply conductors or between either supply conductor and ground. A protective ground connection, by way of the grounding conductor in the power cord, is essential for safe operation.

Use the Proper Fuse

To avoid fire hazard, use only the fuse specified on the line voltage selection switch label, which is identical in type voltage rating, and current rating.

Grounding the 5320A

The enclosure is grounded through the grounding conductor of the power cord. To avoid electrical shock, plug the power cord into a properly wired, earth grounded receptacle before connecting anything to any of the 5320A terminals. A protective ground connection, by way of the grounding conductor in the power cord, is essential for safe operation.

Use the Proper Power Cord

Always use the line power cord and connector appropriate for the voltage and outlet of the country or location in which you are working.

Always match the line cord to the instrument.

- Use the AC line cord supplied with this instrument with this instrument only.
- Do not use this line cord with any other instruments.
- Do not use any other line cords with this instrument.

Use only the power cord and connector appropriate for proper operation of a 5320A in your country.

Use only a power cord that is in good condition.

For detailed information on power cords, refer to Figure 2-1.

Do Not Operate in Explosive Atmospheres

To avoid explosion, do not operate the 5320A in an atmosphere of explosive gas.

Do Not Remove Cover

To avoid personal injury, do not remove the cover from the 5320A. Do not operate the 5320A without the cover properly installed. There are no user-serviceable parts inside the 5320A, so there is never a need for the operator to remove the cover.

Table of Contents

Chapter	Title	Page
1	Introduction and Specifications.....	1-1
	Introduction.....	1-3
	Calibrator Functions	1-3
	Function Descriptions.....	1-3
	Other Features	1-4
	Instruction Manuals	1-4
	5320A Getting Started Manual.....	1-4
	5320A Users Manual.....	1-5
	5320A Service Manual.....	1-5
	Safety Information	1-5
	General Safety Summary.....	1-5
	Symbols.....	1-7
	Contacting Fluke.....	1-8
	Accessories	1-8
	Included Accessories	1-8
	Optional Accessories	1-9
	General Specifications	1-9
	Electrical Specifications	1-10
	Low Resistance Source.....	1-10
	High Resistance Source.....	1-11
	Ground Bond Resistance Source	1-12
	Line/Loop Impedance Source.....	1-13
	Leakage Current Source	1-14
	RCD (Residual Current Device).....	1-15
	AC/DC Voltage Calibrator (5320A/VLC only)	1-15
	Multimeter	1-16
2	Preparing the Calibrator for Operation.....	2-1
	Unpacking and Inspecting the Calibrator	2-3
	Power Considerations	2-4
	Power Cord.....	2-4
	Selecting the Line Voltage	2-5
	Replacing the Fuses.....	2-5
	Installing the Calibrator in an Equipment Rack.....	2-5

Turning Power On	2-6
Operation Rules	2-7
Warm-Up Time	2-7
3 Front-Panel Operation	3-1
Introduction.....	3-3
Controls and Indicators	3-3
Front-Panel Feature Descriptions	3-3
Rear Panel.....	3-7
Display Panel Features	3-8
Controlling the Calibrator	3-9
Selecting a Function	3-9
Setting the Output Signal Value	3-10
Readings	3-12
Connection/Disconnection of Output Terminals	3-12
Calibrator Setup Menu	3-12
Setting a General Setup Function	3-13
Factory Settings	3-15
Error Messages	3-15
4 Calibrating Instruments	4-1
Introduction.....	4-3
Setting the Low Resistance Source Output	4-3
Function Selection	4-3
Setting the High Resistance Source Output	4-5
Function Selection	4-6
Setting the Ground Bond Resistance Output	4-8
Using the Ground Bond Resistance Mode	4-9
Using the Ground Bond Resistance Open Function	4-10
Using the Ground Bond Resistance Transfer Mode	4-11
Using the Loop and Line Impedance Function	4-12
Line and Loop Residual Impedance	4-14
Performing Leakage Current Calibration.....	4-18
Calibrating Passive Leakage Current	4-18
Calibrating Differential Leakage Current	4-19
Calibrating Active Leakage Current (5320A/VLC only)	4-20
Substitute Leakage Current Mode	4-21
Calibrating RCD Test Functions.....	4-23
Calibrating RCD Trip Current Function.....	4-23
Calibrating RCD Trip Time.....	4-26
AC/DC Voltage Calibration (5320A/VLC only)	4-30
Measuring with the Built-in Multimeter	4-32
Function Selection	4-32
Measurements	4-33
5 Remote Operation	5-1
Introduction.....	5-3
Using the IEEE 488 Port for Remote Control	5-3
IEEE 488 Bus Restrictions	5-3
Setting up the IEEE 488 Port.....	5-3
Using the RS-232 Port for Remote Control	5-4
Setting up the RS-232 Port	5-4
RS-232 Connector Pinout.....	5-5

	Exceptions for RS-232 Remote Control	5-5
	Using the Ethernet Connection for Remote Control	5-5
	Factory Settings	5-6
	Command Syntax Information	5-6
	Parameter Syntax Rules	5-6
	Terminators	5-7
	Numeric Output Format	5-7
	Supported SCPI Commands	5-7
	Description of Abbreviations	5-8
	SCPI Command Summary	5-8
	SCPI Command Details	5-17
	Standard Status Data Structures	5-44
	IEEE 488 Interface Configuration	5-48
6	Operator Maintenance	6-1
	Introduction	6-3
	Accessing the Fuses	6-3
	Line-Power Fuse	6-3
	Measurement Input Fuses	6-4
	Cleaning the Air Filter	6-4
	Cleaning the Exterior	6-5
	What to Do In Case of Calibrator Failure	6-5
	Verifying Calibrator Operation	6-6
	Preparing for Calibrator Verification	6-6
	Performing Calibrator Verification	6-6
7	Applications	7-1
	Introduction	7-3
	Calibrating Continuity Testers	7-3
	Calibrating Earth Resistance Testers	7-4
	Calibrating Insulation Resistance Testers	7-5
	Calibrating Insulation Resistance Testers with the Resistance Multiplier	7-8
	Calibrating Ground Bond Resistance Testers	7-10
	Calibrating Ground Bond Resistance Testers with the 5320A Transfer Load Adapter	7-12
	Calibrating Line Impedance Testers	7-13
	Calibrating Loop Impedance Testers	7-15
	Calibrating Leakage Current Testers	7-16
	Passive, Differential and Substitute Leakage Current Calibration	7-16
	Calibrating Residual Current Device (RCD) Testers	7-18
	Calibrating RCD Trip Time	7-18
	Calibrating RCD Trip Current	7-21
	Calibrating AC and DC Voltage (5320A/VLC only)	7-21
	Calibrating Load Test for Appliance Testers	7-24
	Calibrating High Voltage Sources (Hipots) with a High Voltage Probe	7-25
	Measuring High Voltage with the High Voltage Adapter	7-25
	Measuring High Voltage with an 80K-40 High Voltage Probe	7-26
	Measuring Leakage Current with the 5320A-LOAD	7-27
Appendices		
	A Errors	A-1
Index		

List of Tables

Table	Title	Page
1-1.	Included Accessories.....	1-8
1-2.	Optional Accessories.....	1-9
2-1.	Package Contents	2-3
2-2.	Line Power Cord Types Available from Fluke	2-5
3-1.	Front-Panel Features	3-4
3-2.	Rear-Panel Features	3-7
3-3.	Display Panel Features	3-8
3-5.	Factory Settings.....	3-15
3-6.	Error Messages.....	3-16
4-1.	Low Resistance Ranges with Maximum Current Ratings.....	4-3
4-2.	High Resistance Ranges with Maximum Voltage Rating	4-6
4-3.	Selectable Resistance with Maximum Continuous Current and Voltage.....	4-9
4-4.	Series Resistance Values.....	4-25
5-1.	RS-232 Port Connector Pinout.....	5-5
5-2.	Remote Interface Factory Settings	5-6
5-3.	Abbreviation Descriptions.....	5-8
5-3.	OUTPut Command Summary	5-8
5-4.	SOURce Command Summary	5-9
5-5.	SYSTem Command Summary	5-15
5-6.	STATus Command Summary	5-16
5-7.	Common Command Summary.....	5-16
5-8.	Bit Configuration of the Status Byte Register.....	5-46
5-9.	Bit Configuration of the Event Status Register	5-47
5-10.	Supported IEEE 488 Interface Function Subsets	5-48
6-1.	Line Power Fuses	6-3
6-2.	Measurement Input Fuses.....	6-4
6-3.	Required Verification Test Equipment	6-6
6-4.	Low Resistance Source Limits	6-7
6-5.	High Resistance (<10 M Ω) Source Limits	6-9
6-6.	High Resistance (>10 M Ω) Source Limits	6-10
6-7.	Resistance Limits for Multiplier Verification	6-11
6-8.	High Test Current Ground Bond Source Limits	6-12
6-9.	Ground Bond Source Limits	6-13
6-10.	Leakage Current Limits.....	6-15
6-11.	RCD Trip Current Limits	6-16

6-12. RCD Trip Time Limits.....	6-18
6-13. AC Voltage, Frequency Test and Distortion Test Limits.....	6-19
6-14. DC Voltage Limits	6-19
6-15. AC/DC Voltage Multimeter Limits.....	6-20
6-16. AC/DC Current Meter Limits	6-20

List of Figures

Figure	Title	Page
2-1.	Line Power Cord Types Available from Fluke	2-5
3-1.	Keypad Entry Display	3-10
3-2.	Setup Menu	3-12
4-1.	Simplified Low Resistance Source Schematic	4-4
4-2.	Typical Low Resistance Display	4-5
4-3.	Simplified High Resistance Source Scheme	4-7
4-4.	Typical High Resistance Display	4-7
4-5.	Simplified Ground Bond Resistance source.....	4-9
4-6.	Ground Bond Resistance Display	4-10
4-7.	Ground Bond Resistance with Transfer Load Adapter	4-11
4-8.	Transfer Ground Bond Resistance Display	4-12
4-9.	Simplified Line Impedance Source Schematic	4-12
4-10.	Simplified Loop Impedance Source Schematic	4-13
4-11.	Line Impedance Calibration Display.....	4-14
4-12.	Simplified Passive Leakage Current Schematic.....	4-18
4-13.	Simplified Active Leakage Current Scheme.....	4-20
4-14.	Active Leakage Current Warning Message.....	4-21
4-15.	Simplified Substitute leakage current schematic.....	4-22
4-16.	Simplified RCD Scheme	4-23
4-17.	RCD Trip Current Display	4-24
4-18.	RCD Trip Time Process	4-26
4-19.	RCD Trip Time Display	4-27
4-20.	Simplified Voltage Calibrator Schematic.....	4-31
4-21.	AC Voltage Calibrator Display	4-31
4-22.	Multimeter Mode Selection.....	4-33
4-23.	Multimeter Display with Current and Voltage.....	4-34
4-24.	Multimeter Display with Hipot Leakage Current Measurement.....	4-35
4-25.	Multimeter Display with Hipot Timer Measurement.....	4-35
5-1.	Status Register Overview	5-45
6-1.	Low Resistance Calibration Connections	6-7
6-2.	High Resistance Source (<10 M Ω) Calibration Connections	6-8
6-3.	High Resistance Source (>10 M Ω) Calibration Connections	6-9
6-4.	Resistance Multiplier Verification Connections	6-11
6-5.	High Current Bond Resistance Connections	6-13
6-6.	High Test Current Verification with Ohmmeter	6-13

6-7.	Multimeter Current Verification Setup	6-14
6-8.	RCD Trip Current Calibration Connections.....	6-15
6-9.	Trip Time Verification Connections	6-17
6-10.	High Voltage Probe Calibration Connection.....	6-21
6-11.	High Voltage Divider Calibration Connection.....	6-22
7-1.	Resistance Calibration UUT Connections.....	7-4
7-2.	Earth Resistance Calibration Connections	7-5
7-3.	Calibrating Insulation Resistance of an Installation Tester.....	7-5
7-4.	Calibrating Insulation Resistance of a Handheld Insulation Tester	7-6
7-5.	Calibrating Insulation Resistance of a Portable Appliance Tester	7-6
7-6.	Calibrating Insulation Resistance of an Electrical Safety Analyzer.....	7-7
7-7.	Connections to Bench Tester when using Resistance Multiplier Adapter	7-9
7-8.	Connections to 1550B when using Resistance Multiplier.....	7-10
7-9.	Ground Bond Resistance Calibration on Fluke 6500 Using the Cable Adapter	7-11
7-10.	Ground Bond Resistance Calibration on Fluke 6500 using Single Test Leads.....	7-12
7-11.	Ground Bond Resistance Calibration on Bench Ground Bond Tester	7-13
7-12.	Line and Loop Impedance Calibration on a Fluke 1653	7-14
7-13.	Passive Leakage Current Calibration on Fluke 6500	7-16
7-14.	Touch Leakage Current Calibration on Fluke 6500	7-17
7-15.	Active Leakage Current Calibration on Fluke 6500	7-17
7-16.	Leakage Current Calibration on Earth Leakage Tester	7-17
7-17.	RCD Trip Time and Trip Current Calibration.....	7-19
7-18.	Voltage Calibration on Battery-Powered Installation Tester	7-22
7-19.	Voltage Calibration on Line Powered Appliance Testers	7-23
7-20.	Voltage Calibration using Single Wires.....	7-23
7-21.	Voltage and Current Meter Calibration using a Cable Adapter	7-24
7-22.	Voltage and Current Meter Calibration using single wires	7-25
7-23.	10 kV High Voltage Adapter Application.....	7-26
7-24.	40 kV High Voltage Probe Application	7-27
7-25.	Load Schematic	7-27
7-26.	Normal Hipot Calibration Connections.....	7-28
7-27.	Leakage Current Calibrator Display	7-29
7-28.	Hipot Calibration Using Voltage Above 1000 V	7-30

Chapter 1

Introduction and Specifications

Title	Page
Introduction.....	1-3
Calibrator Functions	1-3
Function Descriptions.....	1-3
Instruction Manuals	1-4
5320A Getting Started Manual.....	1-4
5320A Users Manual.....	1-5
Safety Information	1-5
General Safety Summary.....	1-5
Symbols.....	1-5
Contacting Fluke.....	1-8
Accessories	1-8
Included Accessories	1-8
Optional Accessories	1-9
General Specifications	1-9
Electrical Specifications	1-10
Low Resistance Source.....	1-10
High Resistance Source.....	1-11
Ground Bond Resistance Source.....	1-12
Line/Loop Impedance Source.....	1-13
Leakage Current Source	1-14
RCD (Residual Current Device).....	1-15
AC/DC Voltage Calibrator (5320A/VLC only)	1-15
Multimeter	1-16

Introduction

The Fluke 5320A and 5320A/VLC are Multifunction Electrical Tester Calibrators (hereafter referred to as the Calibrator), designed for full calibration and testing of electrical safety testers. Some examples of these testers are:

- Megohm meters
- Ground bond testers
- Loop testers
- RCD testers
- Appliance testers
- Electrical installation testers
- Earth resistance meters
- High voltage safety testers (Hipots)

Calibrator Functions

The Calibrator performs output and measurement functions.

Output Functions:

- Insulation resistance
- Earth resistance and continuity
- Loop, line, and ground bond resistance
- Residual Current Device (RCD) and Ground Fault Circuit Interrupter (GFCI) testing
- Leakage current source
- AC/DC voltage generation (5320A/VLC only)

Measurement functions:

- AC/DC voltage and current measuring
- Load current and power consumption

Function Descriptions

The following sections describe various functions of the Calibrator. Unless otherwise noted, the descriptions apply to both 5320A and 5320A/VLC.

Insulation Resistance

For insulation resistance calibration, the Calibrator acts as a high resistance source from 10 k Ω to 10 G Ω with 4½ digit resolution. A single value 100 G Ω selection is available as well. Depending on the selected resistance value, maximum applied test voltages range from 50 to 1500 volts peak.

Earth Resistance and Continuity

The Calibrator sources low resistance values from 100 m Ω to 10 k Ω with 3½ digits of resolution. This function is used in either 2-wire or 4-wire mode to calibrate continuity testers and earth resistance testers that source currents from 5 to 400 mA.

Loop, Line and Ground Bond Resistance

The Calibrator sources high power rated low resistance standards from 25 m Ω to 1.8 k Ω , which are especially suited for loop impedance, line impedance, and ground bond resistance testing. The Calibrator senses and displays Unit Under Test (UUT) test conditions, types of test current, and current levels up to 40 amps. In the 5320A/VLC, an

Active Loop Compensation module will compensate for residual resistance when performing loop and line impedance calibrations.

Residual Current Device Testing

In the RCD function, the Calibrator acts as a circuit breaker to calibrate trip time in the range of 10 ms to 5 s, and trip current in the range of 3 mA to 3 A. All tested parameters of the UUT are scanned and displayed on the Calibrator's front-panel display.

Leakage Current Source

The Calibrator sources simulated leakage current from 0.1 to 30 mA with a maximum compliance voltage up to 250 V ac. Leakage current modes include touch, substitute, and differential current.

AC/DC Voltage Generation (5320A/VLC Only)

When equipped with the ac/dc voltage calibrator, the Calibrator is capable of calibrating the voltmeter function on many electrical safety testers. The voltage range is 3 to 600 volts both ac and dc. The ac frequency range is 40 to 400 Hz. This voltage source also generates stable power line voltage for powering appliance testers.

Meter Functions

The Calibrator is equipped with a built-in low frequency voltmeter and ammeter. The voltmeter measures up to 1100 volts, while the ammeter measures up to 30 amps. UUT power consumption is calculated by taking the measured voltage and current and then calculating the VA.

Other Features

For ease of use, the Calibrator includes other features such as setup menus, correct power line connection testing, hardware and software overload protection, in addition to many others.

Front-panel control of the Calibrator is accomplished through function keys for frequently used functions, edit controls, and menu selection soft keys. All necessary information such as Calibrator status, menu selections and readings are displayed through a flat luminescent display on the front panel.

The Calibrator is equipped with an IEEE 488 bus, an RS-232 serial port, and a LAN interface for controlling the Calibrator from a PC or instrument controller.

Instruction Manuals

The Calibrator ships with a manual set that contains information for the user and programmer. The set includes:

- 5320A Getting Started Manual (PN 2634331)
- 5320A Users Manual (CD ROM, PN 2634346)
- 5320A Service Manual (CD ROM, PN 2634346)

Order additional copies of these manuals using the part numbers provided. For ordering instructions, refer to a Fluke catalog or contact a Fluke sales representative.

5320A Getting Started Manual

Use this manual for basic setup information, contacting Fluke, unpacking, and general specifications. This manual also provides operation information for the Calibrator,

descriptions of the Calibrator's front and rear-panel features, and information about setting up and powering up the Calibrator. Please read this information before operating the Calibrator.

5320A Users Manual

The Users Manual is available in PDF format on the CD ROM provided with your Calibrator. It contains information on operating the Calibrator from the front panel. The *Calibrating Instruments* section explains the Calibrator's functions and the steps necessary to use them. In addition to operational instructions, this manual also contains information on general maintenance, along with a verification procedure to ensure the Calibrator is operating within specifications.

5320A Service Manual

The Service Manual is available in PDF format in the CD ROM provided with your Calibrator. It contains information for verifying Calibrator operation, calibrating the Calibrator, and troubleshooting down to the module level. A list of replaceable parts with corresponding location diagrams, are also included.

Safety Information

This section addresses safety considerations and describes symbols that may appear in this manual or on the Calibrator.

A **Warning** statement identifies conditions or practices that could result in injury or death.

A **Caution** statement identifies conditions or practices that could result in damage to the Instrument or equipment to which it is connected.

⚠ ⚠ Warning

To avoid electric shock, personal injury, or death, carefully read the information under "General Safety Summary" before attempting to install, use, or service the Instrument.

General Safety Summary

The instrument has been designed for according to EN 61010-1 (2nd Edition). The design reflects the requirements of A2 amendment of the standard.

Safety is ensured by the design and use of specific component types. The manufacturer is not liable for the damage caused by modification to the Calibrator or use of non-original replacement parts.

⚠ ⚠ Warning

To avoid electric shock, personal injury, fire, or death, observe the following warnings before using the Calibrator:

- **Use the Calibrator only as specified in this manual, or the protection provided by the instrument might be impaired.**
- **Do not use the Calibrator in wet environments.**
- **Inspect the Calibrator before using it. Do not use the Calibrator if it appears damaged.**

- **Do not use the Calibrator if it operates abnormally. Protection may be impaired. If in doubt, have the Calibrator serviced.**
- **Have the Calibrator serviced only by qualified service personnel.**
- **Always use the power cord and connector appropriate for the voltage and outlet of the country or location in which you are working.**
- **Connect the Calibrator power cord to a power receptacle with an earth ground. A protective ground connection by way of the grounding conductor in the power cord is essential for safe operation.**
- **Never remove the cover or open the case.**
- **Never operate the Calibrator with the cover removed or the case open.**
- **Use caution when working with voltages above 30 V ac rms, 42 V ac peak, or 60 V dc. These voltages pose a shock hazard.**
- **Use only the replacement fuse(s) specified by the manual.**
- **When servicing the Calibrator, use only specified replacement parts.**

⚠ Warning



























To prevent personal injury, use good lifting practices when lifting or moving the Calibrator. The Calibrator is an unbalanced load and weighs in excess of 18 kg (40 pounds).

⚠ Caution

To prevent damage to the Calibrator, do not use aromatic hydrocarbons or chlorinated solvents for cleaning.

Symbols

The following safety and electrical symbols may be used on the Calibrator or in this manual.

Symbol	Description	Symbol	Description
	Risk of danger. Important information. See manual.		Power ON / OFF
	Hazardous voltage. Voltage > 30 V dc or ac peak might be present.		Earth ground.
	AC (alternating current).		Capacitance.
	DC (direct current).		Diode.
 or 	AC or DC (alternating or direct current).		Laser caution.
			Warning. Laser.
	Continuity test or continuity beeper tone.		Fuse.
	Digital signal.		Warning. Hot or burn hazard.
	Potentially hazardous voltage.	CAT	Overvoltage (installation or measurement) Category.
	Brightness / contrast adjustment		Display backlight
	Double insulated.		Recycle.
	Static awareness. Static discharge can damage part(s).		Do not dispose of this product as unsorted municipal waste. Contact Fluke or a qualified recycler for disposal.
	Do not connect to public network (e.g., telephone system.)		Maintenance or Service.
	Battery or battery compartment. Low battery when shown on display.		Tone or beep.

Contacting Fluke

To order accessories, receive operating assistance, or get the location of the nearest Fluke distributor or Service Center, call:

USA:	1-800-44-FLUKE (1-800-443-5853)
Canada:	1-800-36-FLUKE (1-800-363-5853)
Europe:	+31 402-678-200
Japan:	+81-3-3434-0181
Singapore:	+65-738-5655
Anywhere in the world:	+1-425-446-5500
Service in USA:	1-888-99-FLUKE (1-888-993-5853)

Or, visit Fluke's Web site at www.fluke.com.

To register your product, visit register.fluke.com.

Accessories

The following sections cover the accessories available for the Calibrator. When ordering an accessory after the original purchase, include a reference to the Calibrator, as well as the description from the following tables.

Included Accessories

Table 1-1 lists the accessories included with the Calibrator.

Table 1-1. Included Accessories

Item	Model or Part Number
5320A Getting Started Manual	2634331
5320A User Documentation CD (Getting Started & Users Manuals)	2634346
Fluke Calibration Report with Test Data	N/A
10 KV Adapter – 1000:1 Voltage divider and resistance multiplier.	2743421
5320A Transfer Load Adapter	3362921
Spare Fuses	See tables 6-1 and 6-2 for a list of fuses with part numbers.
Cable adapter - Line plug to 3 banana plugs ^[1]	2743368 (United Kingdom) 2743387 (Europe) 2743400 (Australia/New Zealand)
Cable adapter - Line socket to 3 banana plugs ^[1]	2743379 (United Kingdom) 2743393 (Europe) 2743417 (Australia/New Zealand)
Test lead 1000 V/32 A/50 cm banana-banana red	2743442
Test lead 1000 V/32 A/50 cm banana-banana blue	2743439
Test lead 1000 V/32 A/50 cm banana-banana green	2743456
Test lead 1000 V/32 A/50 cm banana-banana black	2743463
Note:	
[1] Cable adapters are provided with UK, EU, and AP models and not the USA version.	

Optional Accessories

Table 1-2 lists optional accessories for the Calibrator.

Table 1-2. Optional Accessories

Model	Description
5320/CASE	Transit case for 5320A Calibrator
Y5320	Rack mount kit for mounting a 5320A in a standard 19 inch rack.
5320A-LOAD	Load resistor adapter for hipot leakage current calibration

General Specifications

Warm-Up Time	30 minutes
Specifications Confidence Level	99 %
Specifications Interval	1 year
Temperature Performance	
Operating Temperature	18 to 28 °C
Calibration Temperature (tcal)	23 °C
Temperature Coefficient	Temperature coefficient for temperature outside of Tcal ±5 °C between +5 °C to +40 °C is 0.1 x /°C
Storage Temperature	-20 to +70 °C
Relative Humidity (operating)	<70 % to 28 °C
Altitude	
Operating	3,050 m (10,000 ft.)
Storage	12,200 m (40,000 ft.)
Dimensions	450 mm X 480 mm X 170 mm (17.7 in. X 18.9 in. X 6.7 in.)
Weight	18 kg (39.7 lb)
Power Line	115/230 V ac (50/60 Hz) ±10 %, with the maximum voltage difference between Neutral and Protective Earth not exceeding 20 V.
Power Consumption	150 VA Maximum
Safety Class	Class I, Bonded Enclosure
Electrostatic Discharge	This instrument meets class I for ESD requirements per EN 61326 (Criteria A)
⚠ Fuse Protection	
AC mains input	2 A, 250 V for 230 V, Time delay (T2L250 V – 5 x 20 mm) 4 A, 250 V for 115 V, Time delay (T4L250 V – 5 x 20 mm)
RCD input	3.15 A, 250 V, Fast (F3.15L250V – 5 x 20 mm)
Meter amps (A) input	20 A, 500 V, Time delay (T20L500V – 6.3 x 32 mm)
Loop/Line impedance input	4 A, 250 V, Time delay (T4L250V – 6.3 x 32 mm)
Leakage current input	100 mA, 150V, Fast (F100mL150V – 5 x 20 mm)

Electrical Specifications

Low Resistance Source

Total Range 100 mΩ to 10 kΩ
Resolution 3½ digits (continuously variable)

Uncertainty and Maximum Ratings

Range	Resolution	Maximum AC or DC Current ^[1]	2-Wire Uncertainty ^[2] (tcal ±5 °C)	4-Wire Uncertainty (tcal ±5 °C)
100 mΩ to 4.99 Ω	0.1 mΩ	400 mA	0.3 % + 25 mΩ	0.3 % + 10 mΩ
5 to 29.9 Ω	0.01 Ω	250 mA	0.2 % + 25 mΩ	0.2 % + 10 mΩ
30 to 199.9 Ω	0.1 Ω	100 mA	0.2 % + 25 mΩ	0.2 % + 10 mΩ
200 to 499 Ω	1 Ω	45 mA	0.2 %	0.2 %
500 Ω to 1.999 kΩ	1 Ω	25 mA	0.2 %	0.2 %
2 to 4.99 kΩ	10 Ω	10 mA	0.2 %	0.2 %
5 to 10 kΩ	10 Ω	5 mA	0.2 %	0.2 %

Notes:
 [1] Test current can exceed 120 % of maximum current for up to 3 seconds. Terminals automatically disconnect if test current exceeds 120 % of specified maximum current.
 [2] Uncertainty is valid to 200 mW. For higher power rating, add 0.1 % per each 300 mW above 200 mW.

Test Current Measurement

Range 0 to 400 mA ac + dc rms
Resolution 1 mA
Uncertainty $\left(\left(\frac{20}{\sqrt{R}} \right) + 0.1 \right) mA$ R = set resistance between 0.5 Ω to 10 kΩ.

Short Mode

Nominal resistance <50 mΩ
Maximum current 400 mA ac + dc rms

Open Mode

Nominal resistance 30 MΩ ±20 %
Maximum input voltage allowed 50 V ac + dc rms
Test voltage reading 0 to 50 V ac + dc rms
Resolution 1 V
Uncertainty 5 % + 2 V

High Resistance Source

- Range 10 kΩ to 10 GΩ plus 100 GΩ single value selection.
Resolution 4½ Digit (continuously variable for 10 kΩ to 10 GΩ range)

Uncertainty and Maximum Ratings

Range	Resolution	Maximum Voltage (ac + dc) Peak	Uncertainty ^[1] (tcal ±5 °C)
10.000 to 39.99 kΩ	1 Ω	55 V	0.2 %
40.00 to 99.99 kΩ	10 Ω	400 V	0.2 %
100.00 to 199.99 kΩ	10 Ω	800 V	0.2 %
200.0 to 999.9 kΩ	100 Ω	1100 V	0.2 %
1.0000 to 9.999 MΩ	100 Ω	1150 V	0.3 %
10.000 to 999.9 MΩ	1 kΩ	1575 V ^[2]	0.5 %
1.0000 to 10.000 GΩ	100 kΩ	1575 V ^[2]	1.0 %
100 GΩ	NA	1575 V ^[2]	3.0 % ^[3]

Notes:

- [1] Uncertainty is valid to 500 volts. For test voltages above 500 V, add 0.1% for each 200 V above 500 V.
[2] Maximum test voltage with the supplied banana leads is 1000 Vrms. For higher voltages, use leads rated at 1575 V or above.
[3] Calibration value uncertainty is specified in the table. Nominal value is ± 15 %.

Test Voltage Measurement

- Range 0 to 2000 V dc peak
Resolution 1 V
Uncertainty 1 % + 5 V for R above 1 MΩ
1 % + 2 V for R below 1 MΩ
Settling Time 2 seconds for input deviations of <5 %

Test Current Measurement

- Range 0 to 9.9 mA dc
Uncertainty 1.5 % + 5V/R A (where R is the selected resistance value)
Settling time 2 seconds (for voltage reading deviations < 5 %)

Short Mode

- Nominal resistance <100 Ω
Maximum input current allowed 50 mA ac + dc rms
Test current range 0 to 50 mA ac + dc rms
Resolution 0.1 mA
Uncertainty 2 % + 0.5 mA

Resistance Multiplier Adapter (x1000 multiplier)

- Resistance range 350 MΩ to 10 TΩ

Uncertainty and Maximum Ratings

Range	Resolution	Maximum Voltage (ac + dc) Peak	Uncertainty (tcal ±5 °C)
350.0 MΩ to 99.99 GΩ	100 kΩ	10000 V	1.0 % + R ^[1]
100.00 GΩ to 999.9 GΩ	10 MΩ	10000 V	2.0 % + R ^[1]
1.0000 TΩ to 10.000 TΩ	100 MΩ	10000 V	3.0 % + R ^[1]

Notes:

- [1] R is the uncertainty of resistor to be multiplied by 1000.

Ground Bond Resistance Source

Resistance Mode

Range 25 mΩ to 1.8 kΩ
 Resolution 16 discrete values
 Minimum test voltage/current 10 V / 10 mA
 Test Current Measurement Range 0 to 40 A ac + dc rms
 Test Current Measurement Resolution 1 mA to 100 mA depending on resistance output and test current

Uncertainty and Maximum Ratings

Nominal Value	Deviation from Nominal Value	Absolute Uncertainty of Characterized Value (tcal ±5 °C)	Maximum Continuous Test Current ACrms or DC ^[1]	Maximum Short-term Test Current AC rms or DC ^[2]	Test Current Uncertainty
25 mΩ	±50 %	± 5 mΩ	30 A	40 A	1.5 % + 0.7 A
50 mΩ	±50 %	± 5 mΩ	28 A	40 A	1.5 % + 0.5 A
100 mΩ	±30 %	± 5 mΩ	25 A	40 A	1.5 % + 0.35 A
330 mΩ	±20 %	± 7 mΩ	14 A	40 A	1.5 % + 0.3 A
500 mΩ	±10 %	± 8 mΩ	10 A	40 A	1.5 % + 0.2 A
1 Ω	±10 %	± 10 mΩ	8 A	40 A	1.5 % + 150 mA
1.8 Ω	±10 %	± 18 mΩ	6 A	30 A	1.5 % + 100 mA
5 Ω	±10 %	± 30 mΩ	3.2 A	21 A	1.5 % + 70 mA
10 Ω	±10 %	± 60 mΩ	2.0 A	15 A	1.5 % + 50 mA
18 Ω	±10 %	± 100 mΩ	1.5 A	10 A	1.5 % + 30 mA
50 Ω	±10 %	± 300 mΩ	0.8 A	5.0 A	1.5 % + 20 mA
100 Ω	±10 %	± 500 mΩ	0.5 A	3.0 A	1.5 % + 10 mA
180 Ω	±10 %	± 1 Ω	0.25 A	1.35 A	1.5 % + 5 mA
500 Ω	±10 %	± 2.5 Ω	0.1 A	0.6 A	1.5 % + 3 mA
1 kΩ	±10 %	± 5 Ω	0.05 A	0.3 A	1.5 % + 2 mA
1.8 kΩ	±10 %	± 10 Ω	0.025 A	0.15 A	1.5 % + 2 mA

Notes:

- [1] Test currents up to 30 % of maximum continuous test current can be applied to the Calibrator with no time limitation. Test current between 30 % and 100 % of the maximum continuous test current can be applied to the Calibrator for a limited time. Minimum period of full current load is 45 seconds. The Calibrator calculates the allowed time period and when exceeded, the output connectors are disconnected.
- [2] Maximum short term test current is defined as the rms value of halfwave or fullwave test current flowing through the UUT. Maximum time of test is 200 ms. A time interval of 200 ms represents 10 full waves of power line voltage at 50 Hz and 12 full waves at 60 Hz.

Open Mode

Nominal resistance >100 kΩ
 Maximum voltage 50 V ac + dc rms
 Test voltage range 0 to 50 V ac + dc rms
 Resolution 1 V
 Uncertainty 2 % + 2 V

Transfer Mode

Transfer Ground Bond Resistance Accuracy in mΩ

Transfer GBR (mΩ)	Marking on Display	UUT Test Current							
		30 A	28 A	25 A	20 A	14 A	10 A	8 A	3 A
50	0	±0.8 mΩ	±0.8 mΩ	±0.8 mΩ	±0.9 mΩ	±1.0 mΩ	±1.2 mΩ	±1.3 mΩ	±2.6 mΩ
80	R1	±0.9 mΩ	±1.0 mΩ	±1.0 mΩ	±1.0 mΩ	±1.2 mΩ	±1.4 mΩ	±1.5 mΩ	±2.9 mΩ
120	R2	-	±1.1 mΩ	±1.1 mΩ	±1.2 mΩ	±1.3 mΩ	±1.5 mΩ	±1.7 mΩ	±3.1 mΩ
170	R3	-	-	±1.4 mΩ	±1.4 mΩ	±1.6 mΩ	±1.8 mΩ	±2.0 mΩ	±3.6 mΩ

Transfer Ground Bond Resistance Accuracy in mΩ (cont)

Transfer GBR (mΩ)	Marking on Display	UUT Test Current							
		30 A	28 A	25 A	20 A	14 A	10 A	8 A	3 A
420	R4	-	-	-	-	±3.0 mΩ	±3.3 mΩ	±3.6 mΩ	±6.0 mΩ
550	R5	-	-	-	-	-	±4.1 mΩ	±4.4 mΩ	±7.2 mΩ

Maximum and Minimum Applicable Test Currents from the Ground Bond Resistance Meter

5320A Transfer GBR (mΩ)	UUT Minimum Test Current AC/DC (A)	UUT Maximum Test Current AC/DC (A)
50	3	30
80	3	30
120	3	28
170	3	25
420	3	14
550	3	10

Notes

- The minimum value of the indicated test current is 0.05 A.
- The transfer GBR indication as the main value on the display is shown when the test current is 3 A or greater.

Line/Loop Impedance Source

Range 25 mΩ to 1.8 kΩ
 Resolution 16 discrete values
 Minimum test voltage/current 10 V/10 mA

Uncertainty and Maximum Ratings

Nominal Resistance Value	Deviation from Nominal Value	Absolute Uncertainty of Characterized Value (tcal ±5 °C)	Maximum Continuous Test Current AC rms or DC ^[1]	Maximum Short-term Test Current AC rms or DC ^[2]	Test Current Uncertainty
25 mΩ	±50 %	±5 mΩ	30 A	40 A	1.5 % + 0.7 A
50 mΩ	±50 %	±5 mΩ	28 A	40 A	1.5 % + 0.5 A
100 mΩ	±30 %	±5 mΩ	25 A	40 A	1.5 % + 0.35 A
330 mΩ	±20 %	±7 mΩ	14 A	40 A	1.5 % + 0.3 A
500 mΩ	±10 %	±8 mΩ	10 A	40 A	1.5 % + 0.2 A
1 Ω	±10 %	±10 mΩ	8 A	40 A	1.5 % + 150 mA
1.8 Ω	±10 %	±18 mΩ	6 A	30 A	1.5 % + 100 mA
5 Ω	±10 %	±30 mΩ	3.2 A	21 A	1.5 % + 70 mA
10 Ω	±10 %	±60 mΩ	2.0 A	15 A	1.5 % + 50 mA
18 Ω	±10 %	±100 mΩ	1.5 A	10 A	1.5 % + 30 mA
50 Ω	±10 %	± 300 mΩ	0.8 A	5.0 A	1.5 % + 20 mA
100 Ω	±10 %	± 500 mΩ	0.5 A	3.0 A	1.5 % + 10 mA
180 Ω	±10 %	± 1 Ω	0.25 A	1.35 A	1.5 % + 5 mA
500 Ω	±10 %	± 2.5 Ω	0.1 A	0.6 A	1.5 % + 3 mA
1 kΩ	±10 %	± 5 Ω	0.05 A	0.3 A	1.5 % + 2 mA
1.8 kΩ	±10 %	± 10 Ω	0.025 A	0.15 A	1.5 % + 2 mA

Notes:

- [1] Test currents up to 30 % of maximum continuous test current can be applied to the Calibrator with no time limitation. Test current between 30 % and 100 % of the maximum continuous test current can be applied to the Calibrator for a limited time. Minimum period of full current load is 45 seconds. The Calibrator calculates the allowed time period and when exceeded, the output connectors are disconnected.
- [2] Maximum short term test current is defined as the rms value of halfwave or fullwave test current flowing through the UUT. Maximum time of test is 200 ms. A time interval of 200 ms represents 10 full waves of power line voltage at 50 Hz and 12 full waves at 60 Hz.

Test Current Measurement

Type of recognized test current	Positive impulse (halfwave), negative impulse (halfwave), symmetrical (fullwave).
Range	0 to 40 A ac + dc rms
Resolution	1 to 100 mA depending on test current and resistance output

Prospective Fault Current

Range	0 to 10 kA
-------------	------------

Correction Manual Mode

Residual Impedance Range	0 to 10 Ω
Resolution	1 m Ω
Uncertainty	Uncertainty in manual (MAN) mode is the uncertainty of selected resistance value. See table above. Also, the uncertainty of the manually entered correction should be taken into consideration.

Correction Scan Mode

Residual Impedance Range	0 to 10 Ω
Resolution	1 m Ω
Uncertainty	(1 % + 15 m Ω) + uncertainty of selected resistance value.

Correction COMP Mode (Active Loop Compensation) (5320A/VLC only)

Residual Impedance Range	0 to 2 Ω
Maximum Test Current	<25/N A pk, where N equals number of UUT generated test current periods.
Uncertainty of compensation	(1 % + 15 m Ω) + uncertainty of selected resistance value. Uncertainty is valid at the point in time when the COMP function is initiated.

Leakage Current Source

Range	0.1 to 30 mA
Resolution:	
Passive Mode	10 μ A setting, 1 μ A measurement
Differential Mode	10 μ A setting, 1 μ A measurement
Substitute Mode	10 μ A
Active Mode (5320A/VLC only)	10 μ A
Test Voltage:	
Passive Mode	60 to 250 V ac + dc rms
Differential Mode	60 to 250 V ac + dc rms
Substitute Mode	10 to 250 V ac + dc rms
Active Mode (5320A/VLC only)	50 to 100 V ac + dc rms
Uncertainty:	
Passive Mode	0.3 % + 2 μ A ac + dc rms
Differential Mode	0.3 % + 2 μ A ac + dc rms Test uncertainty can be influenced by power line voltage instability
Substitute Mode	0.3 % + 2 μ A ac + dc rms
Active Mode (5320A/VLC only)	0.3 % + 1 μ A ac + dc rms

RCD (Residual Current Device)

Trip Current Range:

- 0.5 X I and 1 X I Mode 3 to 3000 mA in 1 mA steps
- 1.4 X I and 2 X I Mode 3 to 1500 mA in 1 mA steps
- 5 X I Mode 3 to 600 mA in 1 mA steps

- Trip Current Measurement Resolution** 1 μ A on 30 mA range
 10 μ A on 300 mA range
 100 μ A on 3A range

Uncertainty:

- 0.5 X I and 1 X I Mode 1 % rms
- 1.4 X I and 2 X I Mode 2 % rms
- 5 X I Mode 5 % rms

Trip Time Range 10 to 5000 ms

Trip Time Uncertainty 0.02 % + 0.25 ms

Series Resistance 0.025 Ω , 0.05 Ω , 0.1 Ω , 0.33 Ω , 0.5 Ω , 1 Ω , 1.8 Ω , 5 Ω , 10 Ω , 18 Ω ,
 50 Ω , 100 Ω , 180 Ω , 500 Ω , 1000 Ω , 1800 Ω

Line/Touch Voltage Range 250 V

Line/Touch Voltage Uncertainty 5 % + 3 V

AC/DC Voltage Calibrator (5320A/VLC only)

Range 3 to 600 V, ac or dc

Resolution 4 digits

Internal Ranges:

- AC Mode 30, 100, 300, and 600 V (Autoranging only)
- DC Mode 30, 150, and 600 V (Autoranging only)

Frequency:

- Range 40 to 400 Hz
- Resolution 3 digits
- Uncertainty 0.02 %

Settling Time 300 ms to 3 s, depending on output value

AC Voltage

Uncertainty and Maximum Burden Current

Range	Resolution	Uncertainty \pm (% of Output + mV)	Maximum Burden Current
3 – 29.99 V	0.001 V	0.1 % + 9	500 mA
30 – 99.99 V	0.01 V	0.1 % + 30	300 mA
100 – 299.9 V	0.1 V	0.1 % + 90	150 mA
300 – 600 V	0.1 V	0.1 % + 180	50 mA

DC Voltage

Uncertainty and Maximum Burden Current

Range	Resolution	Uncertainty \pm (% of Output + mV)	Maximum Burden Current
3 – 29.99 V	0.001 V	0.1 % + 9	2 mA
30 – 149.9 V	0.01 V	0.1 % + 45	3 mA
150 – 600 V	0.1 V	0.1 % + 180	5 mA

AC Output Signal Distortion 0.2 % \pm 10 mV (harmonic distortion and non-harmonic noise from 20 Hz to 500 kHz), for output power lower than 10 VA on each range.

Sensing Ammeter Current Range 500 mA

Resolution 1 mA

Uncertainty \pm 5 mA

Multimeter

Voltage

Range	0 to 1100 V ac rms or dc
Resolution	4½ digits
Internal Ranges	10, 100, and 1100 V (Autoranging only)
Frequency Range	DC, 20 Hz to 2 kHz
Input Resistance	10 MΩ ±1 %
Time Constant	1.5 s
Readings/Second	2
Measurement Category	1000 V CAT I, 300 V CAT II

AC/DC Voltage Uncertainty

Range	Resolution	Uncertainty ±(% of Reading + mV)
10 V	0.001 V	0.15 % + 5
100 V	0.01 V	0.20 % + 50
1100 V	0.1 V	0.20 % + 550

Current

Range	0 to 20 A continuous, 30 A for up to 30 minutes, ac rms or dc
Resolution	4½ digits
Internal Ranges	300 mA, 3 and 30 A (Autoranging only)
Frequency Range	DC, 20 to 400 Hz
Time Constant	1.5 s
Readings/Second	2

AC/DC Current Uncertainty

Range	Resolution	Uncertainty ±(% of Reading + mA)
300 mA	0.1 mA	0.15 % + 0.15
3 A	1 mA	0.15 % + 1.5
30 A	10 mA	0.30 % + 15

Phantom Power

Range	0 to 33 kVA
Resolution	3 digits
Uncertainty	$\sqrt{(V_{unc})^2 + (I_{unc})^2}$ where V_{unc} is specified uncertainty of measured voltage and I_{unc} is specified uncertainty of measured current.

Hipot Leakage Current Measurement Mode

Range	0 to 300 mA ac rms or dc
Resolution	4 1/2 digits
Frequency range	DC, 20 Hz to 400 Hz
Time constant	1.5 s
Readings/second	2

Hipot Leakage Current Mode Uncertainty

Range	Resolution	Uncertainty ±(% of reading + μA)
300 μA	0.01 μA	0.3 % + 0.21
3 mA	0.1 μA	0.2 % + 1.5
30 mA	1 μA	0.2 % + 15
300 mA	10 μA	0.2 % + 150

Hipot Timer Measurement Mode

Range	0.1 to 999 s
Resolution	1 ms
Uncertainty	0.02 % + 2 ms (dc) 0.02 % + 20 ms (ac)

10 kV Adapter (1000:1 voltage divider)

Range	0 to 10 kV ac peak/dc
Resolution	4½ digits
Uncertainty	0.3 % of value + 5 V dc 0.5 % of value + 5 V ac at 50 or 60 Hz

80K-40 High Voltage Probe

Range	0 to 40 kV ac peak/dc
Resolution	4½ digits
Uncertainty	0.5 % of value + 10 V dc 0.5 % of value + 10 V ac at 50 or 60 Hz

Chapter 2

Preparing the Calibrator for Operation

Title	Page
Unpacking and Inspecting the Calibrator	2-3
Power Considerations	2-4
Power Cord.....	2-4
Selecting the Line Voltage	2-5
Replacing the Fuses.....	2-5
Installing the Calibrator in an Equipment Rack.....	2-5
Turning Power On	2-6
Operation Rules	2-7
Warm-Up Time.....	2-7

Unpacking and Inspecting the Calibrator

⚠️ Warning

The Calibrator is capable of supplying lethal voltages. To avoid electric shock, do not touch the Calibrator’s output terminals. Read this section before operating the Calibrator.

The Calibrator is shipped in a container that is specially designed to prevent damage during shipping. Inspect the Calibrator carefully for damage, and immediately report any damage to the shipper. Instructions for inspection and claims are included in the shipping container.

If you need to reship the Calibrator, use the original container. If it is not available, you can order a new container from Fluke by identifying the Calibrator’s model and serial number.

When you unpack the Calibrator, check for all the standard equipment listed in Table 2-1. Report any shortage to the place of purchase or to the nearest Technical Service Center. Visit Fluke web site for Service Center locations.

If performance tests are required for your acceptance procedures, refer to Chapter 6 of the 5320A Users Manual for instructions. Line power cords available from Fluke are listed in Table 2-2 and illustrated in Figure 2-1.

Table 2-1. Package Contents

Item	Model or Part Number
Multifunction Electrical Tester Calibrator	5320A or 5320A/VLC or 5320A/40 or 5320A/VLC/40
Line Power Cord	See Table 2-2 and Figure 2-1
5320A Getting Started Manual	2634331
5320A User Documentation CD (Getting Started & Users Manuals)	2634346
Fluke Calibration Report with Test Data	N/A
10 KV Adapter – 1000:1 Voltage divider and resistance multiplier.	2743421
5320A Transfer Load Adapter	3362921
Spare Fuses	See tables 6-1 and 6-2 for a list of fuses with part numbers.
Cable adapter - Line plug to 3 banana plugs ^[1]	2743368 (United Kingdom) 2743387 (Europe) 2743400 (Australia/New Zealand)
Cable adapter - Line socket to 3 banana plugs ^[1]	2743379 (United Kingdom) 2743393 (Europe) 2743417 (Australia/New Zealand)
Test lead 1000 V/32 A/50 cm banana-banana red	2743442
Test lead 1000 V/32 A/50 cm banana-banana blue	2743439
Test lead 1000 V/32 A/50 cm banana-banana green	2743456
Test lead 1000 V/32 A/50 cm banana-banana black	2743463
Note:	
[1] Cable adapters are provided with UK, EU, and AP models and not the USA version.	

The calibrator is designed to be supplied by 230 or 115 V, 50 or 60 Hz ac power (mains). It is a laboratory instrument whose parameters are guaranteed at 23 ± 5 °C. Before powering on the instruments, place it on a level surface. Do not cover the vents at the bottom side and the fan opening at the rear panel.

Power Considerations

The Calibrator operates on varying power distribution standards found throughout the world, and must be set up to operate on the correct line voltage that will power it. The Calibrator is packed ready for use with a line voltage determined at the time of ordering. If the selected line voltage does not match the power the Calibrator will be plugged into, then the Calibrator's line voltage setting must be changed and the line fuse replaced.

Power Cord

A power cord that will mate with the power receptacles found in the area to which the Calibrator is shipped is included with each Calibrator. Table 2-2 lists the line power cords used with the Calibrator.

Warning

To avoid shock hazard, connect the factory supplied three-conductor line power cord to a properly grounded power outlet. Do not use a two-conductor adapter or extension cord; this will break the protective ground connection. If a two-conductor power cord must be used, a protective grounding wire must be connected between the ground terminal and earth ground before connecting the power cord or operating the instrument.

After you verify that the line voltage selection switches are set to the correct positions, verify that the correct fuse for that line voltage is installed. Connect the Calibrator to a properly grounded three-prong outlet.

Table 2-2. Line Power Cord Types Available from Fluke

Type	Voltage	Fluke Part No.
North America/Japan	120 V	2743310
Universal Euro	240 V	2743331
United Kingdom	240 V	2743322
Australia/China	240 V	2743346
South Africa/India	240 V	2743354

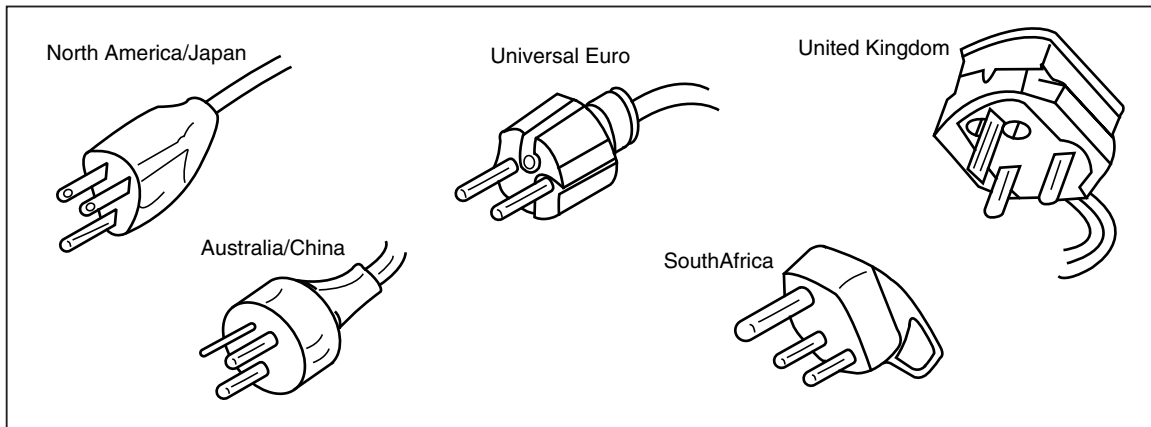

Figure 2-1. Line Power Cord Types Available from Fluke

Selecting the Line Voltage

The Calibrator will operate on two different input line voltages. The present line voltage setting is indicated on the outside of the line voltage switch found on the Calibrator’s rear panel.

To change the line voltage:

1. Disconnect the Calibrator from line power by unplugging the line power cord.
2. Using a flat-blade screwdriver, rotate the switch until the desired voltage is under the arrowhead on the line voltage switch.
3. Ensure the proper Line Power fuse for the selected line voltage selection is installed in the Calibrator. See Table 6-1.
4. Attach the Calibrator to the power source using a line power cord that will mate with power source outlet.

Replacing the Fuses

The Calibrator uses fuses to protect both the line power input and measurement inputs. Refer to the Operators Maintenance section of this manual for instructions on replacing the Calibrator’s fuses.

Installing the Calibrator in an Equipment Rack

The Calibrator can be mounted in a standard-width, 24-inch (61-cm) deep equipment rack. To mount the calibrator in an equipment rack, use the Rack Mount Kit, Model

Y5320A, instructions are included with the kit. For convenience, the rack mount instruction sheet can be stored in the supplied binder of this manual.

Turning Power On

With the Calibrator setup for the proper line voltage, press the power switch on the back panel so the “I” side of the switch is depressed. During its power-up cycle, the Calibrator displays a power supply test screen while initializing internal circuits and checking the mains connection. The mains connection tests are:

- **Power line voltage test** – The line voltage must be within preset limits. For the 230 V setting, the range must be between 180 V and 260 V. For the 115 V setting, the limits are between 90 V to 130 V.

Note

The Calibrator requires standard nonsymmetrical power line mains (NT) with line (hot) wire, protection earth, and neutral wire.

- **Power line frequency test** – The frequency must be within preset limits: 49 Hz to 51 Hz or 59 Hz to 61 Hz.
- **Potential difference and polarity test** – The potential difference between neutral and protective earth must be less than 15 V.

The screen in Figure 2-2 is displayed when the Calibrator completes these tests.

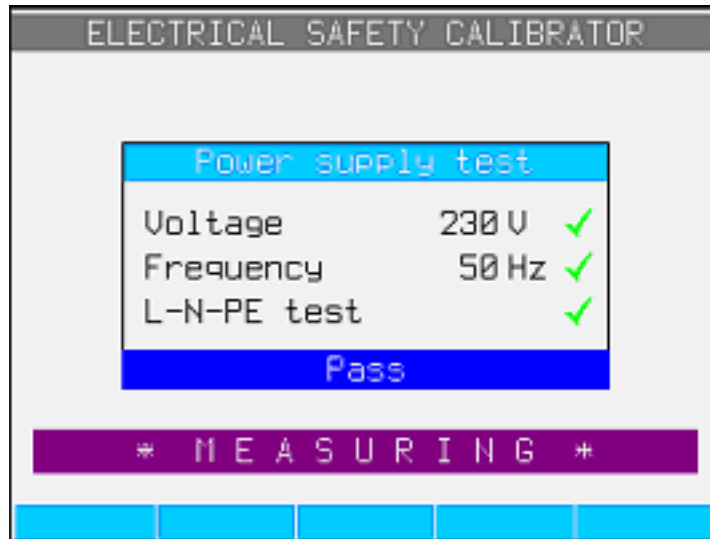

Figure 2-2. Initialization Complete Screen

ehq020.bmp

If the Calibrator detects that the power line is improperly connected, for example the line or hot wire is crossed with the neutral wire, it will display “Fail.” In this case, remove the power cord and correct the problem before trying to turn the Calibrator on. The Calibrator will display “Pass” for several seconds while it performs additional internal circuitry tests, if all tests pass and the power line is properly connected. A similar “Fail” indication is displayed in the voltage and frequency tests if the power supply voltage or frequency is out of specified limits.

Note

The polarity of the neutral and the line wires must be correct for the 5320A to power on. If the “L-N-PE” test fails during the power-on process, the neutral and the line wires could be miswired at the Mains connection socket. This probable wiring error must be corrected. Only a qualified service technician should make this change.

When the initialization tests finish, the Calibrator resets to a reference state of Meter mode operation.

Note

The Calibrator resets to its reference state whenever line power is removed and then reapplied to the Calibrator.

Operation Rules

The following rules should be strictly observed to guarantee correct operation of the calibrator:

- The calibrator can only be switched on and off by pressing the power switch located at the rear panel.
- Do not connect the Calibrator to a power source with a voltage other than that set by the voltage selector on the rear panel.
- Do not block the vent openings located at the rear and bottom panels.
- Keep all liquids and small objects from entering the Calibrator through the vent openings.
- The Calibrator must not be operated in a dusty environment. It was designed to be used in a laboratory.
- Do not operate the Calibrator outside its operating temperature range.
- Connect the instruments to be calibrated to the proper output terminals. There is no way to protect the Calibrator from damage caused by improper connections.
- Do not plug in banana connectors that are larger than that for which the terminals were designed.
- Whenever possible, use the setup menu to ground the LO output terminal (GND on the setup function).
- If the instruments to be calibrated are not connected to the Calibrator’s output terminals using their original cables, ensure that only cables suitable for the calibration voltage and current are used.

Warm-Up Time

Once the Calibrator reaches its reference state, it can be used for calibration. However, the Calibrator will only make calibrations to its specified accuracy after it has been allowed to warm-up for at least 30 minutes.

Note

During these first 30 minutes, the Calibrator itself cannot be calibrated. If calibration is attempted during this period, the Calibrator will display “cannot access the calibration”.

Chapter 3

Front-Panel Operation

Title	Page
Introduction.....	3-3
Controls and Indicators.....	3-3
Front-Panel Feature Descriptions.....	3-3
Rear Panel.....	3-7
Display Panel Features.....	3-8
Controlling the Calibrator.....	3-9
Selecting a Function.....	3-9
Setting the Output Signal Value.....	3-10
Numeric Keyboard.....	3-10
Cursor Key Editing.....	3-11
Editing Values with Knob Control.....	3-11
Readings.....	3-12
Connection/Disconnection of Output Terminals.....	3-12
Calibrator Setup Menu.....	3-12
Setting a General Setup Function.....	3-13
Setting the Date.....	3-13
Setting the Time.....	3-13
Enabling/Disabling the Beeper.....	3-13
Setting the Beeper Volume.....	3-14
Setting the Display Brightness.....	3-14
Setting the Calibration Password.....	3-14
Viewing the Device Information.....	3-14
Factory Settings.....	3-15
Error Messages.....	3-15

Introduction

The Calibrator can be controlled either by sending commands through one of its communication interfaces or by manual manipulation of its front-panel controls. This chapter explains the function and use of the controls and indicators located on the front and rear panel, of the Calibrator. This chapter is meant to be of an overview of the Calibrator. Detailed information on using the Calibrator is found in Chapter 4, “Calibrating Instruments”. Chapter 5 covers operating the Calibrator through its remote communication interfaces.

Controls and Indicators

The following sections describe the various controls, indicators, and connectors used to interface and source signals to a Unit Under Test (UUT).

Front-Panel Feature Descriptions

Table 3-1 lists the controls and connectors found on the front panel.

Warning

To avoid electric shock, use only high-quality, shrouded test leads with the appropriate CAT and voltage rating to connect instruments to the Calibrator.

Table 3-1. Front-Panel Features

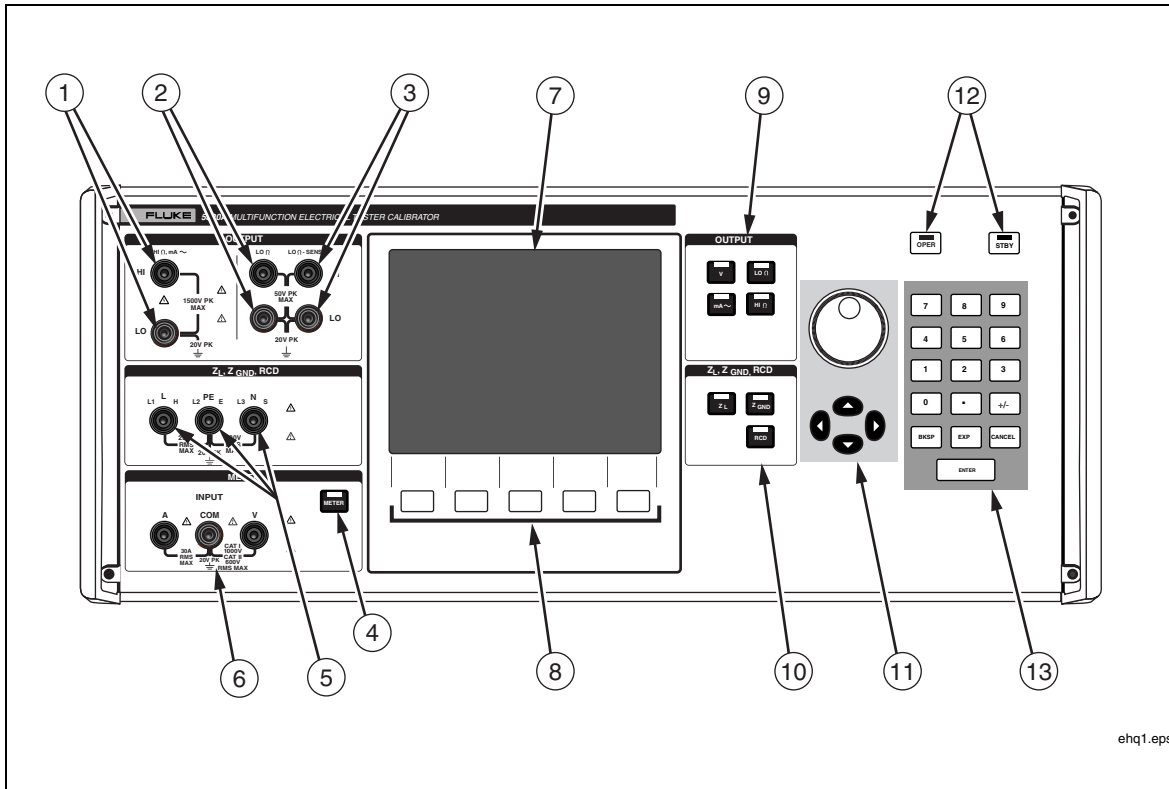

ehq1.eps

Item	Description
① OUTPUT Terminals	<p>⚠ ⚠ Warning</p> <p>Electric shock hazard. Lethal voltages are either applied to or supplied from these terminals when the Calibrator is operating. Ensure the Calibrator and UUT is in standby mode before connecting or removing leads to these terminals. Up to 600 V ac or dc is supplied from these terminals when the Voltage function is operating.</p> <p>Provides connection points for ac and dc voltage and current as well as high resistance.</p>
② LO Ω Terminals	<p>Provides connection points for low resistance. Use these two source terminals for 2-wire ohms measurements. They are also source terminals for 4-wire measurements.</p>
③ LO Ω Sense Terminals	<p>Provides connection points for the sensing of low resistance.</p>
④ 	<p>Selects the meter function.</p>

Table 3-1. Front-Panel Features (cont.)



























Item	Description								
⑤ Impedance and RCD Terminals	<p style="text-align: center;">⚠ ⚠ Warning</p> <p>Electric shock hazard. Lethal voltages are either applied to or supplied from these terminals when the Calibrator is operating. Ensure the Calibrator and UUT is in standby mode before connecting or removing leads to these terminals. AC Line Voltage is supplied from these terminals when the Calibrator is performing a Loop Impedance, Line Impedance or RCD calibration.</p> <p>Provides connection points for the Loop and Line impedance testing as well as RCD testing and Ground Bond Resistance testing.</p>								
⑥ Meter Terminals	<p>Provides connection points for meter measurements. The V terminal is for ac and dc voltages. The A terminal is for ac and dc currents. The COM terminal is the return for all meter measurements.</p>								
⑦ Display Panel	<p>A 16-color active LCD display panel used to indicate Calibrator status, output levels, measured voltage, resistance and current, and active terminals. In addition, the bottom line of the display indicates the function of the five softkeys just below the display panel. See the “Display Panel” section below for more details on the displayed information.</p>								
⑧ Softkeys	<p>The functions of the five unlabeled softkeys are identified by labels in the display panel directly above each key. The functions change during operation so that many different functions are accessible through these keys. A group of softkey labels is called a menu. A group of interconnected menus is called a menu tree.</p>								
⑨ Output Function Keys	<p>Selects the output function. The output functions are:</p> <table style="margin-left: 20px;"> <tr> <td style="text-align: center;"></td> <td>AC/DC Voltage Calibration (5320A/VLC only)</td> </tr> <tr> <td style="text-align: center;"></td> <td>Low Resistance</td> </tr> <tr> <td style="text-align: center;"></td> <td>Leakage Current</td> </tr> <tr> <td style="text-align: center;"></td> <td>High Resistance</td> </tr> </table>		AC/DC Voltage Calibration (5320A/VLC only)		Low Resistance		Leakage Current		High Resistance
	AC/DC Voltage Calibration (5320A/VLC only)								
	Low Resistance								
	Leakage Current								
	High Resistance								
⑩ Impedance and RCD Keys	<p>Selects the impedance and RCD functions. These functions are:</p> <table style="margin-left: 20px;"> <tr> <td style="text-align: center;"></td> <td>Loop/Line Impedance</td> </tr> <tr> <td style="text-align: center;"></td> <td>Ground Bond Resistance</td> </tr> <tr> <td style="text-align: center;"></td> <td>RCD Time & Trip current</td> </tr> </table>		Loop/Line Impedance		Ground Bond Resistance		RCD Time & Trip current		
	Loop/Line Impedance								
	Ground Bond Resistance								
	RCD Time & Trip current								

Table 3-1. Front-Panel Features (cont.)

Item	Description
	<p>Output adjustment controls; if any of these keys are pressed or the knob is rotated, a digit on the output area of the display is highlighted. The output increments or decrements as the knob is rotated. If a digit rolls past 0 or 9, the digit to its left or right is carried.</p> <p>When making a menu selection, pushing in on the knob is equivalent to pressing the SELECT softkey. When editing a number, pressing in on the knob will switch between moving the cursor between characters and changing the selected character's value. Arrow icons above and below the selected digit indicate which of the two modes are active.</p> <p>The  and  keys adjust the magnitude of changes by moving the highlight between the digits. The  and  keys increment and decrement respectively the value of the highlighted digit.</p>
	<p>Controls the application of output signals to the output terminals. The OPER and STBY have LEDs imbedded in them to indicate whether or not the output signal is applied (Operate) or not (Standby).</p>
	<p>Provides number keys for keying in the output amplitude, selecting menu items, and other data such as the time and date. To enter a value, press the digits of the output value, a multiplier key if necessary, an output function key, and then press ENTER.</p>

⚠⚠ Warning

To avoid electric shock, ensure the Calibrator is in standby before making connections to the following terminals:

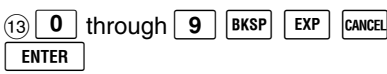
- **HI and LO OUTPUT terminals for the Voltage function (up to 600 V ac or dc in operate mode).**
- **L, PE and N terminals (line voltage is present when in operate for the RCD and Z_L modes).**

Rear Panel

Table 3-2 lists the items found on the Calibrator’s rear panel.

Table 3-2. Rear-Panel Features

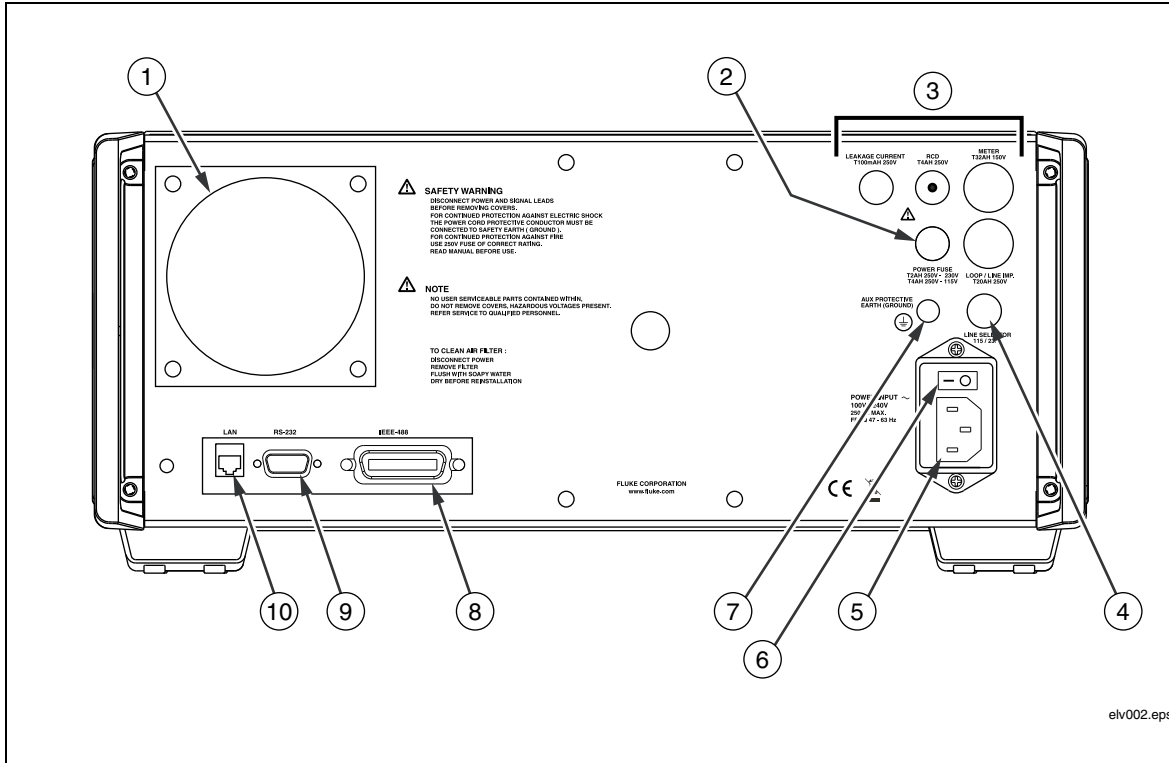

Item	Description
① Fan Filter	The filter covers the air intake to keep dust and debris out of the chassis. A fan inside the Calibrator provides a constant cooling air flow throughout the chassis.
② Line Power Fuse Holder	The line power fuse. Refer to “Accessing the Fuses”.
③ Signal Fuse Holders	These fuses protect the signal outputs and inputs. Refer to “Accessing the Fuses”.
④ Line Voltage Selection Switch	Selects the line voltage. Refer to Selecting Line Voltage earlier in the manual.
⑤ AC Power Input Connector	A grounded male three-prong connector that accepts the line power cord.
⑥ AC Power Switch	Turns Calibrator ac power on and off.
⑦ Chassis Ground Binding Post	A binding post that is internally grounded to the chassis. If the Calibrator is the ground reference point in a system, this binding post can be used for connecting other instruments to earth ground. (The chassis is normally connected to earth ground through the three conductor line cord instead of through the earth ground binding post.)

Table 3-2. Rear-Panel Features (cont.)

Item	Description
⑧ IEEE 488 Port	A standard interface for operating the Calibrator in remote control as a Talker or Listener on the IEEE 488 Bus. Refer to Chapter 5 of this Manual for bus connection and remote programming instructions.
⑨ RS-232 Port	A female serial port (DCE) connector for transmitting internal calibration constant data to a printer, monitor, or host computer, and for remote control of the Calibrator. Chapter 5 of this Manual describes proper cabling, how to set up the serial interface, and how to transmit data from the Calibrator.
⑩ LAN Port	An RJ45 LAN connector for remote control of the Calibrator. Chapter 5 of this Manual describes proper cabling, how to set up the LAN interface, and how to transmit data from the Calibrator.

Display Panel Features

The 16 color active LCD display panel is used to display the Calibrator’s status, errors, measured values, and set parameters. Each Calibrator function has its own screen layout to accommodate the appropriate data. A system of Menu selections for Calibrator setups, function controls, and help text is also displayed.

Table 3-3 lists the different areas of the display and the information contained in them.

Table 3-3. Display Panel Features

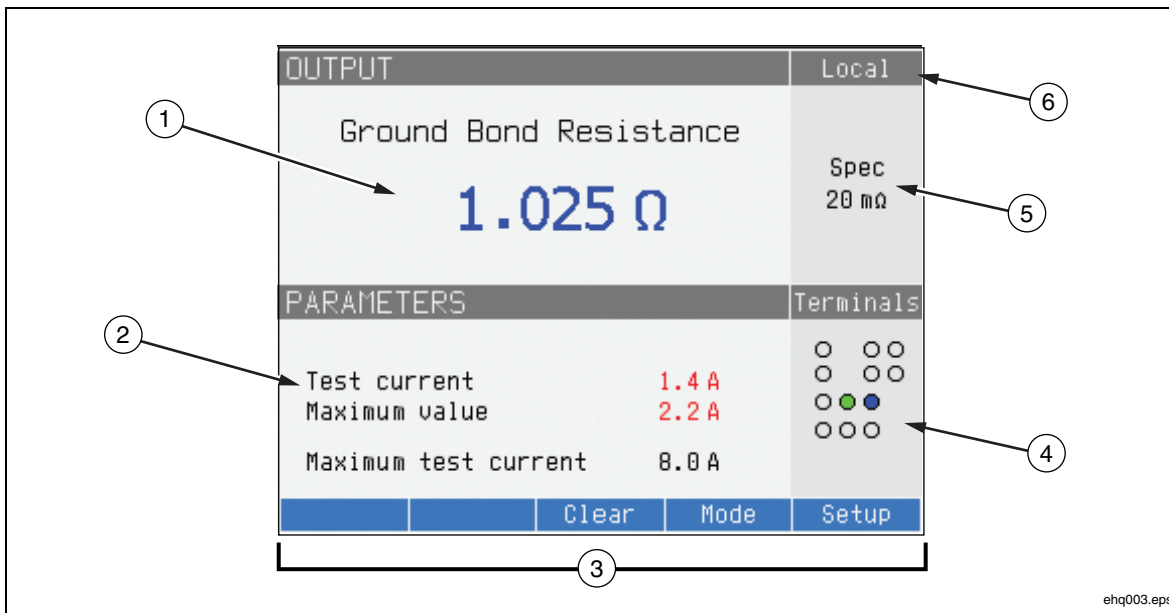

ehq003.eps

Item	Description
① Output	Displays the selected function and their parameters.
② Parameters	Displays auxiliary measurements and parameters for the selected function.

Table 3-3. Display Panel Features (cont.)

Item	Description
③ Softkey labels	Displays the labels for the five soft keys below the display.
④ Terminals	Displays the active terminals for the selected function.
⑤ Specifications	Displays the accuracy of the output signal or measured parameter. If the Calibrator is outputting two signals, two accuracy specifications are displayed here. If the Calibrator is not within specifications, BUSY is displayed instead of the specification.
⑥ Local or Remote	Displays which of the two control modes is enabled.

Display Colors: A set of common rules are used to apply color to labels and values appearing in the display.

1. Red denotes a value that is measured or scanned by the Calibrator (2.2 A in this example).
2. Blue denotes a value or parameter that can be set or changed through the front-panel keyboard or a setup function (1.025 mΩ in this example).
3. Black denotes fixed values, labels, notes or parameters which cannot be modified (8 A in this example).
4. White on a Blue field is always used for softkey labels.

Controlling the Calibrator

The following sections give an overview of basic Calibrator operation. More detailed use is described in Chapter 4.

Selecting a Function

Once the Calibrator is powered on and the self-test has completed successfully, the Calibrator sets itself to its reference state of Meter mode.

To change the Calibrator's state:

1. Press the desired function key.

Whenever a different function is selected, the Calibrator uses the parameters that were set the last time the function was used.

Note

Whenever the function changes, the Calibrator always switches to STANDBY mode.

⚠ ⚠ Warning

To avoid electric shock, always be sure the Calibrator and the UUT are in STANDBY mode before removing or connecting leads to the front-panel connectors.

2. Make the appropriate connections between the Calibrator and UUT. Refer to the Terminals area of the display as a guide.

3. If necessary, make changes to the functions parameters through the setup menu by pressing the softkey under **Setup**. To return to the function selected without changing the parameters, press the softkey under **Exit**.
4. With the desired function selected, function parameters set, and the UUT properly connected to the Calibrator, press the OPER key to activate the Calibrator's outputs.

Note

The help guide shows information on the selected function that may help with proper function settings. To access the help guide, press the **Mode** softkey and select **Help**. The guide is available in six languages: English, German, French, Spanish, Italian, and Chinese. When finished reading the help messages, press the **Exit** softkey to return to the selected function.

Setting the Output Signal Value

All Calibrator functions allow setting the primary and auxiliary parameter values in three different ways: Numeric keyboard, Cursor keys and Rotary Knob. The cursor keys and rotary knob are also used to make menu selections in the setup window.

Note

If an entry results in overflow or underflow of the Calibrator's range, a "Value too Large" or "Value too Small" error message will appear.

Numeric Keyboard

To enter a value using the numeric keypad:

1. Tap out the numeric value using **0** through **9**, then **ENTER** to accept.

When the first digit is pressed on the keypad, an input box as shown in Figure 3-1 appears in the PARAMETERS field. The units for the selected function are also displayed in the softkey label area.

Note

The softkey labels change to match the function selected.

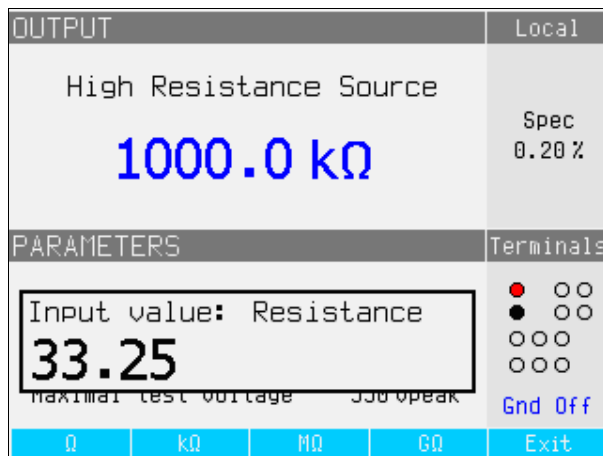

Figure 3-1. Keypad Entry Display

ehq021.bmp

2. With the desired value displayed, press the softkey for the appropriate units or add an exponent value by pressing **EXP**, followed by the value, and then press **ENTER** to complete the entry or press a softkey with the desired terminator (kΩ for example).

Note

*To exit the numeric entry without entering the typed value, press **CANCEL**.*

The Calibrator changes the parameter to the value entered, displays the entered value and the input box disappears.

3. To exit the edit mode, press the **Exit** softkey.

Cursor Key Editing

To enter a value using the cursor keys:

1. Press any one of the cursor keys to start an entry.

An arrowhead pointing up appears above a digit and an arrowhead pointing down appears below the same digit to indicate which digit is being edited.

2. Press **▲** to increase or **▼** to decrease the active digit.
3. Press **◀** or **▶** to move to the next adjacent digit.
4. To return to the main screen, press the **Exit** softkey.

Editing Values with Knob Control

The Calibrator's knob control will work independently or in conjunction with the cursor keys. To enter a value using the Knob:

1. Press in on the Knob to enter the edit mode.

Because the knob is used to position the cursor on a digit and increment or decrement a digit, icons above and below the digit indicate which of the two movements the knob is set for: digit selection or digit setting.

Digit selection is indicated by a left-pointing arrow above the digit and a right-pointing arrow below the digit. Rotating the knob when these icons are displayed moves the cursor to an adjacent digit.

Digit setting is indicated by an upward-pointing arrowhead above a digit and a downward-pointing arrowhead below the same digit. Rotating the knob when these icons are displayed increments or decrements the digit.

Note

To switch between digit selection and digit setting, press in on the knob. Each press of the knob toggles between the two movements.

2. While in the digit setting mode, rotate the knob clockwise to increase the selected digit or counterclockwise to decrease the selected digit. When the digit reaches 9, further clockwise rotation sets the present digit to zero and increments the digit to the left by one. When the digit reaches 1, further counterclockwise rotation sets the selected digit to 9 and decrements the digit to the left by one. If the selected digit is the most significant digit, decrementing it from 1 to 0 will cause the digit to go blank.
3. To exit the edit mode, press the **Exit** softkey.

Readings

Readings taken by the Calibrator's functions are displayed either in the OUTPUT/INPUT area or PARAMETERS area of the display. All readings are displayed in red with an appropriate units label. If a reading is outside the specified limits of the function, the Calibrator disconnects the active terminals and displays an error message of "Input overloaded".

Connection/Disconnection of Output Terminals

Whenever the Calibrator is powered up, all terminals are disconnected and the amber LED in the STBY key is illuminated. To connect the output signal to the Output Terminals, press **OPER**. The green LED inside the OPER key will illuminate and the amber LED in the STBY key will extinguish.

To disconnect the Output Signal from the Output Terminals, press **STBY**. The green LED in the OPER key extinguishes and the amber LED in the STBY key illuminates indicating the calibrator is ready but the terminals are disconnected.

Note

Whenever the function changes, the Calibrator always switches to STANDBY mode.

If at any time a voltage over 50 V is generated or detected on the input or output terminals, the Calibrator displays "Danger – High Voltage" in the output area of the display.

While the Calibrator is in the operate mode, and the output voltage is below 50 volts, the output terminals will be disconnected if the volt increases to 50 volts or above. After the higher voltage is set, press **OPER** to reconnect the output terminals with the higher voltage.

Calibrator Setup Menu

A setup menu permits setting some of the Calibrator's operational parameters. There are setup selections for general Calibrator operation as well as specific Calibrator functions. This section explains the Calibrator's general setups, while the more function specific setups are covered in the sections associated with each function or feature.

To access the setup menu, press the **Setup** softkey.

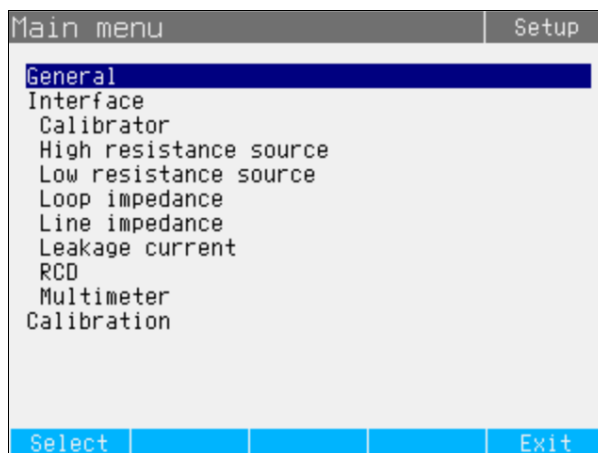

Figure 3-2. Setup Menu

ehq056.bmp

Setting a General Setup Function

The general setup selections are used to set the time, date, beeper on/off, beeper volume, display brightness, time on display, and calibration password. You can also view the Calibrator serial number, software versions, and installed options through the General Setup menu selection.

To access the General Setup functions:

1. Press \blacktriangle or \blacktriangledown or rotate the rotary knob to highlight **General** in the setup menu screen
2. To select the highlighted setup selection, either press the **Select** softkey or press in on the rotary knob.

Setting the Date

To set the date:

1. After entering the setup menu, press \blacktriangle or \blacktriangledown or rotate the rotary knob to highlight “Date” in the list of setup selections.
2. Press the **Select** softkey or press in on the rotary knob.
3. Use \blacktriangleleft or \blacktriangleright to position the cursor on the least significant digit of the year, month or day. The cursor only rests on the least significant digit.

The displayed format of the date is dd/mm/yyyy.

4. Use the \blacktriangle or \blacktriangledown or rotate the rotary knob to change the date element.
5. Press the **Exit** softkey to accept the date and exit the date setting function.

Setting the Time

To set the time:

1. After entering the setup menu, press \blacktriangle or \blacktriangledown or rotate the knob to highlight **Time** in the list of setup selections.
2. Press the **Select** softkey or press in on the rotary knob.
3. Use \blacktriangleleft or \blacktriangleright to position the cursor on the least significant digit of the hours, minutes, or seconds. The cursor only rests on the least significant digit.
4. Use \blacktriangle or \blacktriangledown or rotate the knob to change the time element.
5. Press the **Exit** softkey to accept the date and exit the date setting function.



Enabling/Disabling the Beeper

To enable or disable the Calibrator’s beeper:

1. After entering the setup menu, press \blacktriangle or \blacktriangledown or rotate the knob to highlight “Beeper” in the list of setup selections.
2. Press the **Select** softkey or press in on the rotary knob.
3. Move the cursor with the rotary knob or cursor keys to highlight either “Beeper On” or “Beeper Off”
4. Press the **Select** softkey or press in on the rotary knob.

Setting the Beeper Volume

To set the beeper volume:

1. After entering the setup menu, press  or  or rotate the rotary knob to highlight “Beeper Volume” in the list of setup selections.
2. Press the **Select** softkey or press in on the rotary knob.
3. Set the beeper’s volume between 0 and 15 using the rotary knob, the cursor keys or by entering the value directly with the keypad.



Note

For safety warnings and messages, the beeper will still sound even when the beeper volume is set to zero.

4. Press the **WRITE** softkey to set the beeper volume and return to the setup menu.

Setting the Display Brightness



To set the brightness of the display:

1. After entering the setup menu, press  or  or rotate the rotary knob to highlight “Display Brightness” in the list of setup selections.
2. Press the **Select** softkey or press in on the rotary knob.
3. Set the display’s brightness between 0 and 7 using the rotary knob, the cursor keys, or by entering the value directly with the keypad.
4. Press the **Write** softkey to set the display’s brightness and return to the setup menu.

Setting the Calibration Password



The calibration password is set to “0235” when shipped from the factory. Only when the password is changed to a non-zero value must a password be entered to access the calibration mode. The purpose of the password is to prevent unauthorized users from changing the calibration settings.

To set the calibration code:

1. After entering the setup menu, press  or  or rotate the rotary knob to highlight “Calibration Password” in the list of setup selections.
2. Press the **Select** softkey or press in on the rotary knob.
3. If the calibration password is set to a non-zero value, you will be prompted to enter the present password.
4. Use the keyboard to enter a new code and press . Make sure what is displayed in the display and what you think you entered are the same. After completing the next step, you must have the correct password to gain access to the calibration functions.
5. Press the **Write** softkey to set the calibration password and return to the setup menu. To exit setting the password without changing it, press **Exit**.

Viewing the Device Information

To view Calibrator information (serial number, software versions, and installed options):

1. After entering the setup menu, press  or  or rotate the rotary knob to highlight “Device Information” in the list of setup selections.
2. Press the **Select** softkey or press in on the rotary knob.
3. After viewing the information, press the **Exit** softkey.

Factory Settings

Table 3-4 lists the setup functions and their respective factory set values.

Table 3-4. Factory Settings

Setup Item	Factory Set Value
Volume	15
Brightness	6
Beeper	ON
Calibration password	0235
Time	GMT
Date	GMT
Voltage calibrator	Yes/No
Loop Compensator	Yes/No
Calibrator GND	ON
High resistance source GND	ON
R multiplier input	0 M Ω
Low resistance source GND	ON
Loop impedance correction	OFF
Loop impedance MAN value	0.000 Ω
Loop impedance SCAN value	0.000 Ω
Loop Serial Resistance	0.000 Ω ^[1]
Line impedance correction	OFF
Line impedance MAN value	0.000 Ω ^[1]
Line impedance SCAN value	0.000 Ω ^[1]
Line Serial Resistance	0.000 Ω ^[1]
Substitute LC Rout	2.000 Ω
RCD I level	90 %
RCD serial resistance	R1
Meter GND	OFF
[1] Set to an instrument unique resistance value during initial calibration.	

Error Messages

Error messages appear in the Calibrator's display when either an invalid operation is attempted or some internal check reveals a problem with the Calibrator. Some conditions that generate error messages are:

- Invalid front-panel operations that try to force a prohibited mode, such as setting an out-of-range value.

- Internal faults such as a communications error between functional parts of the Calibrator.
- Invalid commands to the communications interface.

Table 3-5 lists the error messages and possible corrective action you can take to attempt to clear the problem.

Table 3-5. Error Messages

Error Message	Description	Corrective Action
Warm start	Start after internal reset	
Cold start	Start after switching on	
Value too large	Maximum value is out of limit	Attempt to set value over possible range. Set correct value.
Value too small	Minimum value is out of limit	Attempt to set value under possible range. Set correct value.
Negative value	Negative value instead of positive was entered	Enter correct polarity.
Temperature too high	Calibrator power stage overheated	
Test voltage unstable	Unstable test voltage	
Test voltage too high	Power line voltage is over 265 V	
Impedance too high	Residual loop/line impedance is over 2 Ω	Residual loop or line impedance compensator cannot be activated.
Overload voltage output!	AC/DC calibrator output overloaded	Reduce the load at the Calibrator's output.
High temperature!	Internal temperature too high	Output stages are overloaded. Do not use ranges 200 V, 1000 V, or 20 A for at least 10 minutes. Check if the ventilation holes are clear.
FBK error!	Internal error	Turn off the calibrator and turn it on again.
Interface error!	GPIB communication error	Wrong data format on GPIB.
Bad command!	Bad command of GPIB	Unknown command on GPIB.
Bad communication!	GPIB communication error	Listener not connected to the GPIB. Check correct connection of GPIB cable.
Over range!	Exceeded the range limits via GPIB	Value out of range was set via GPIB. Set correct value.
Bad calib. code!	Bad calibration code	Wrong calibration code was entered, calibration cannot start. Enter correct calibration code.
Time warm up!	Attempt to start internal calibration before warm up	Attempt to start calibration before 60 minutes warm up period. Wait 60 minutes before starting calibration.
Internal RxD timeout!	Internal error	Internal error of the calibrator. Turn the calibrator off, wait 5 seconds, then turn it on. If the error appears again, contact Fluke.
Internal communication!	Internal error	Internal error of the calibrator. Turn the calibrator off, wait 5 seconds, then turn it on. If the error appears again, contact Fluke.
Calibrator is not ready!	Internal error	Internal error of the calibrator. Turn the calibrator off, wait 5 seconds, then turn it on. If the error appears again, contact Fluke.

Chapter 4

Calibrating Instruments

Title	Page
Introduction.....	4-3
Setting the Low Resistance Source Output.....	4-3
Function Selection.....	4-3
Setting the High Resistance Source Output.....	4-5
Function Selection.....	4-6
Setting the Ground Bond Resistance Output.....	4-8
Setting the Loop and Line Impedance Output.....	4-12
Line and Loop Residual Impedance.....	4-14
Selecting the Residual Impedance Correction Mode.....	4-15
Setting the Manual Residual Impedance Correction Value.....	4-16
Setting the Scanned Residual Impedance Correction Value.....	4-16
Setting the Compensation Residual Impedance Correction Value.....	4-17
Performing Leakage Current Calibration.....	4-18
Calibrating Passive Leakage Current.....	4-18
Calibrating Differential Leakage Current.....	4-19
Calibrating Active Leakage Current (5320A/VLC only).....	4-20
Substitute Leakage Current Mode.....	4-21
Calibrating RCD Test Functions.....	4-23
Calibrating RCD Trip Current Function.....	4-23
Power Line Voltage.....	4-25
Touch (contact) Voltage.....	4-25
Calibrating RCD Trip Time.....	4-26
Power Line Voltage.....	4-28
Touch (contact) Voltage.....	4-28
AC/DC Voltage Calibration (5320A/VLC only).....	4-30
Measuring with the Built-in Multimeter.....	4-32
Function Selection.....	4-32
Measurements.....	4-33

Introduction

This chapter describes using the Calibrator’s functions for calibrating testers and meters. It is assumed the reader is already familiar with the Calibrator’s controls, connections, and indicators covered in Chapter 3, “Front Panel Operation”. The reader should also be familiar with the safety information contained in Chapter 1 of this manual.

Setting the Low Resistance Source Output

The Calibrator’s Low Resistance Source function is capable of sourcing a resistance in the range listed in Table 4-1 on its output terminals. The maximum acceptable current is dependent on the selected range and is also listed in Table 4-1. The maximum applied voltage is 25 volts. Exceeding these current and voltage limits will cause the Calibrator to disconnect the output terminals and display an error message.

Table 4-1. Low Resistance Ranges with Maximum Current Ratings

Resistance Range	Maximum Current (ac or dc)
100.0 mΩ to 4.99 Ω	400 mA
5 to 29.9 Ω	250 mA
30 to 199.9 Ω	100 mA
200 to 499 Ω	45 mA
500 Ω to 1.999 kΩ	25 mA
2.00 to 5.00 kΩ	10 mA
5.00 to 10.0 kΩ	5 mA

Function Selection

To set the low resistance output:

1. Press .

There are four selectable modes to the Low Resistance Source function: Resistance 2-wire and Resistance 4-wire, Short, and Open. The Mode selected the last time the low resistance function was used is set.

The Short selection is used to short the Calibrator’s output terminals for zero point compensation of the UUT. The Calibrator does not measure current in this mode. The Open selection causes the Calibrator’s input impedance to go higher than 10 MΩ to measure the maximum test voltage applied to the connectors. This measured voltage is displayed in the PARAMETERS area of the display as Test Voltage and Maximum value. Pressing the **Clear** softkey will clear this value from the display during measurements.

2. If **Open** or **Short** is displayed, press the **Mode** softkey. Then, using the cursor keys or rotary knob, highlight **Resistance 2-Wire** or **Resistance 4-Wire** and select it by pressing **Select** or pushing in on the rotary knob.
3. Set the resistance value using the keyboard, cursor keys or rotary knob.

The resistance for this function is output through the terminals with either a 2-wire or 4-wire connection. For 2-wire resistance calibration, connections to the UUT are made using the **LO Ω HI** and **LO Ω LO** terminals. For 4-wire resistance calibration, additional connections are necessary using the **LO Ω -SENSE HI** and **LO Ω -SENSE LO** terminals. See *To change between 2-Wire and 4-Wire resistance* below to change this setting.

Note

4-wire resistance mode is used for low resistance calibrations of UUTs equipped with the 4-wire measurement capability.

The resistance on the Calibrator's terminals can be either floating or grounded. When grounded, the **LO Ω LO** terminal is connected to earth ground through the ground in the power line socket using an internal relay. Whether the output is grounded is indicated in the terminals part of the display. See "To switch between grounded and ungrounded output" below to change this setting.

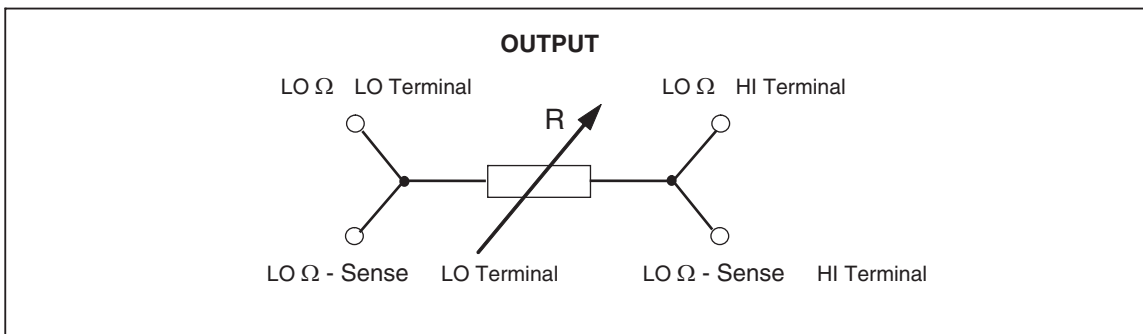

ehq010.eps

Figure 4-1. Simplified Low Resistance Source Schematic

4. With the Terminals area of the display as a guide, connect the UUT's terminals to the Calibrator's terminals.
5. After confirming the settings and connections are correct, press **OPER** to connect the UUT to the selected resistance.

While connected to the UUT, the Calibrator monitors the voltage and current appearing across the resistance. If the current or voltage exceeds acceptable limits, the Calibrator will disconnect the output terminals and display an error message. The actual current flowing in the resistance, along with the maximum allowed current, is displayed in the PARAMETERS area of the display.

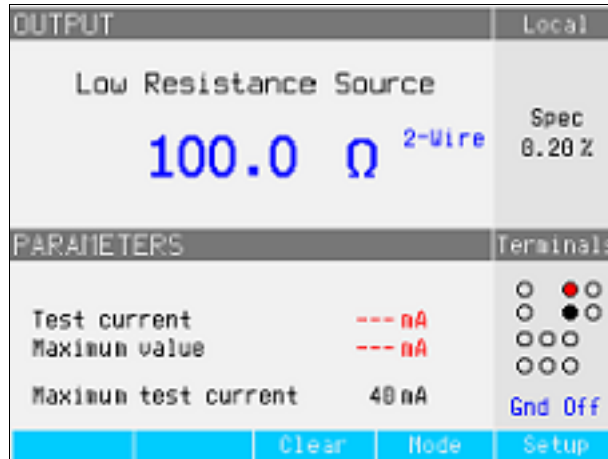

ehq022.bmp

Figure 4-2. Typical Low Resistance Display

Note

Before adjusting the value, make sure the current generated by the UUT will not exceed the maximum allowed value.

With the output connected, you can adjust the resistance value with the keyboard, cursor keys or rotary knob. Any new values set using the front panel take approximately 500 ms to appear on the output terminals. Should the set value exceed the upper range limit or lower range limit, the Calibrator displays “Value too Large” or “Value too Small”, respectively.

To change between 2-wire and 4-wire operation:

1. Press the **Mode** softkey.
2. Using the cursor keys or rotary knob, move the cursor to **Resistance 2-Wire** or **Resistance 4-Wire** and either press the **Select** softkey or press in on the rotary knob.

2-Wire or 4-Wire will be displayed next to the resistance value in the OUTPUT area of the display.

To switch between grounded and ungrounded output:

1. Press the **Setup** softkey.
2. Using the cursor keys or rotary knob, highlight **Low resistance source** and either press the **Select** softkey or press in on the rotary knob.
3. Using the cursor keys or rotary knob, highlight **Low resistance source GND** and either press the **Select** softkey or press in on the rotary knob.
4. Using the cursor keys or rotary knob, highlight either **GND On** or **GND Off** and either press the **Select** softkey or press in on the rotary knob.
5. Return to the main display by pressing the **EXIT** softkey repeatedly.

Setting the High Resistance Source Output

The calibrator’s High Resistance Source function is capable of presenting a resistance in the range listed in Table 4-2 on its output terminals. The maximum acceptable voltage on this resistance is dependent on the selected range and is also listed in Table 4-2.

Table 4-2. High Resistance Ranges with Maximum Voltage Rating

Resistance Range	Maximum applicable voltage (AC+DC)PEAK
10.000 to 39.99 kΩ	55 V
40.00 to 99.99 kΩ	400 V
100.00 to 199.99 kΩ	800 V
200.0 to 999.9 kΩ	1,100 V ^[1]
1.000 to 9.999 MΩ	1,500 V ^[1]
10.000 to 99.99 MΩ	1,575 V ^[1]
100.00 MΩ to 999.9 GΩ	1,575 V ^[1]
1.0000 to 10.000 GΩ	1,575 V ^[1]
100 GΩ	1,575 V ^[1]
Notes:	
[1] Maximum test voltage with the supplied banana leads is 1000 Vrms. For higher voltages, use leads rated at 1575 V or above.	

Use the high voltage divider/resistance multiplier to increase the resistance range to 10 TΩ with a maximum test voltage of 10 kV.

Function Selection

To set the high resistance output:

1. Press **HI Ω**.

There are three selectable modes to the High Resistance Source function: Resistance, 100 GΩ, and Short.

The Short selection is used to short the Calibrator's output terminals to test for maximum test current. This measured current is displayed in the PARAMETERS area of the display as Maximum value.

2. If **Short** is displayed, press the **Mode** softkey. Then, using the cursor keys or rotary knob, highlight **Resistance** and select it by pressing **Select** or pushing in on the rotary knob.
3. The value established the last time the high resistance function was used is set and displayed in the output area of the display.
4. Use the keypad, cursor keys, or rotary knob to set the resistance value.

For this function, the resistance is output through the terminals with either a 2-wire or 3-wire connection. For 2-wire resistance calibration, connections to the UUT are made through the **HI Ω HI** and **HI Ω LO** terminals. For 3-wire calibration, ground potential is available on the **METER COM** terminal. Whether or not the output is grounded is indicated in the terminals part of the display.

Note

3-wire resistance mode is sometimes necessary to improve calibration stability. This is especially true for resistances over 100 MΩ. The third terminal is usually connected to the guard or ground terminal on the UUT. If the UUT is equipped with a GND terminal, it should be connected to the PE terminal.

The resistance on the Calibrator’s terminals can either be floating or grounded. When grounded, the **HIΩ LO** terminal is connected to earth ground in the power line socket through an internal relay. See “To switch between grounded and ungrounded output” below to change this setting.

5. Using the Terminals part of the display as a guide, connect the UUT’s terminals to the Calibrator’s terminals.
6. After confirming all settings and connections are correct, press **OPER** to connect the UUT to the selected resistance.

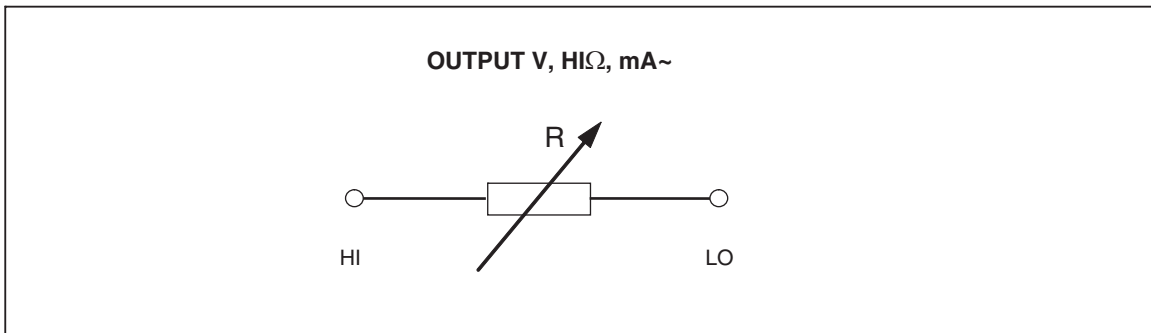

Figure 4-3. Simplified High Resistance Source Scheme

While connected to the UUT, the Calibrator monitors the voltage appearing across the resistance. The measured voltage, the maximum voltage and current, along with the maximum allowed voltage across the selected resistor, displayed is shown in the PARAMETERS area of the display.

OUTPUT		Service
High Resistance Source		Spec
1000.0 kΩ		0.30 %
PARAMETERS		Terminals
Test voltage	--- V DC	● ○○
Maximum value	--- V DC	● ○○
Test current	-.- mA DC	○ ● ○
R multiplier	No	○○○
Maximum test voltage	1100 Upeak	Gnd On
R Mult.	Clear	Mode
		Setup

Figure 4-4. Typical High Resistance Display

⚠ Caution

To avoid overloading the Calibrator, make sure the voltage applied by the UUT will not exceed the maximum allowed value before adjusting the output value.

With the output connected, you can adjust the resistance value with the keyboard, cursor keys, or rotary knob. Any new values set using the front panel can take approximately 500 ms to actually appear on the output terminals. If during the adjustment, the current or voltage exceeds acceptable limits, the output terminals will be disconnected and an error message displayed. If the set value should exceed the upper range limit or lower range limit, the Calibrator displays “Value too Large” or “Value too Small”, respectively.

To switch between grounded and ungrounded output:

1. Press the **Setup** softkey.
2. Using the cursor keys or rotary knob, highlight **High resistance source** and either press the **Select** softkey or press in on the rotary knob.
3. Using the cursor keys or rotary knob, highlight **High resistance source GND** and either press the **Select** softkey or press in on the rotary knob.
4. Using the cursor keys or rotary knob, move the cursor to **GND On** or **GND Off** and either press the **Select** softkey or press in on the rotary knob.
5. Return to the main display by pressing the **Exit** softkey repeatedly.

The high resistance multiplier (a standard accessory) may be used to extend the Calibrator’s range to 10 T Ω . To activate the High Voltage/Resistance Multiplier, press the **R Mult.** softkey. **Yes** should appear to the right of **R multiplier** in the PARAMETERS area of the display. Pressing the **R Mult.** softkey again turns off the resistance multiplier.

Setting the Ground Bond Resistance Output

For calibrating ground bond resistance functions in ground bond testers and portable appliance testers, the Calibrator presents selective resistance values from 25 m Ω to 1.8 k Ω on its output terminals. Table 4-3 lists the 16 selectable resistance settings, along with their maximum current and voltage ratings. There are several operating modes for ground bond resistance calibration accessible through the softkey labeled **MODE**. The normal mode is the resistance mode that connects one of 16 resistors to the terminal. The **OPEN** mode sets an open circuit at the terminals. The **TRANSFER** mode initiates a special dual measurement and resistance sourcing mode used with the lower resistance values. This mode uses the voltage and current measurement capabilities of the Calibrator to measure the sourcing signals of the GBR tester to determine the effective resistance at the terminals during calibration. It also simplifies connections. The 5320A Transfer Load Adapter is used to simultaneously connect the Ground Bond Resistance tester to both the Z_{GND} impedance and meter terminals of the Calibrator.

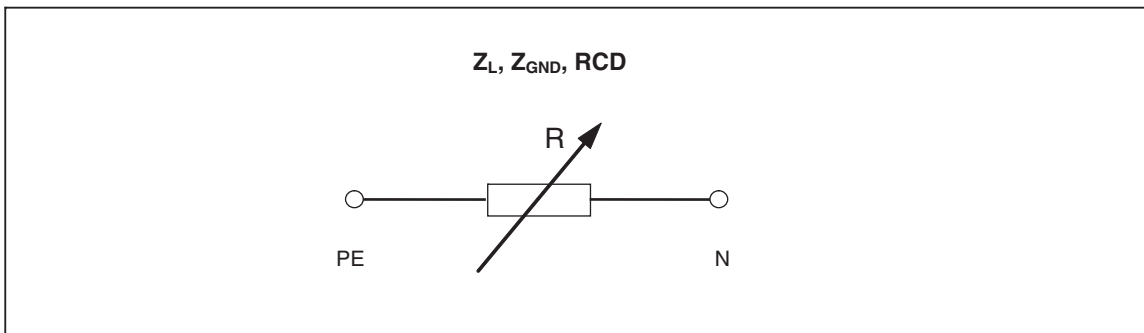

Figure 4-5. Simplified Ground Bond Resistance source

ehq012.eps

Table 4-3. Selectable Resistance with Maximum Continuous Current and Voltage

Nominal Resistance Value	Maximum Continuous Test Current AC(RMS) or DC ^[1]	Maximum Continuous Test Voltage AC(RMS) or DC
25 mΩ ^[2]	30 A	0.75 V
50 mΩ ^[2]	28 A	1.4 V
100 mΩ ^[2]	25 A	2.6 V
330 mΩ ^[2]	14 A	3.6 V
500 mΩ ^[2]	10 A	5 V
1 Ω	8 A	8 V
1.8 Ω	6 A	12 V
5 Ω	3.2 A	16 V
10 Ω	2.0 A	20 V
18 Ω	1.5 A	30 V
50 Ω	0.8 A	40 V
100 Ω	0.5 A	50 V
180 Ω	0.25 A	50 V
500 Ω	0.1 A	50 V
1 kΩ	0.05 A	50 V
1.8 kΩ	0.03 A	50 V

Note:
 [1] For short-term allowable test current, see the specifications in chapter 1 of this manual.
 [2] For more accurate calibration, use the Transfer Ground Bond Resistance Adapter.

Using the Ground Bond Resistance Mode

To set the Ground Bond resistance output:

1. Press **ZGND**.

The default mode is the resistance mode. The value used the last time the ground

bond resistance function was used is set and displayed in the output area of the display. If already in the Ground Bond Function, press the softkey labeled **MODE**.

Using the cursor keys or rotary knob, highlight RESISTANCE and either press the **Select** softkey or press in on the rotary knob.

2. Set the resistance value using the rotary knob. The keypad can also be used to enter a value. If the entered value is not exactly one of the 16 possible selections, the resistance closest to the value entered will be selected.
3. Using the Terminals part of the display as a guide, connect the UUT's terminals to the Calibrator's PE and N terminals of the Z_L , Z_{GND} and RCD terminals. These terminals are always floating from ground.
4. After confirming all settings and connections are correct, press **OPER** to connect the UUT to the selected resistance.

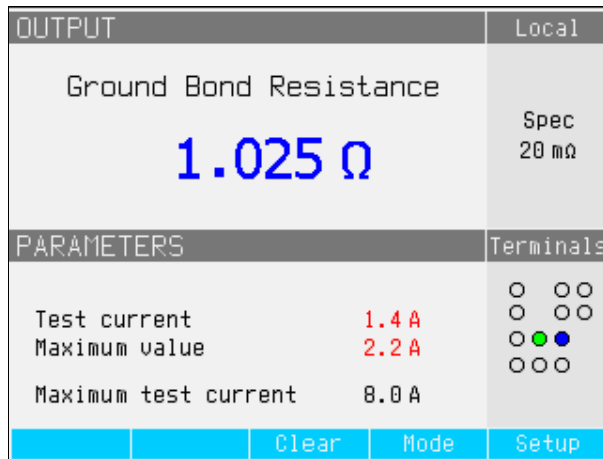

ehq024.bmp

Figure 4-6. Ground Bond Resistance Display

While connected to the UUT, the Calibrator monitors the voltage and current appearing across the resistance. The actual current flowing through the resistance, the max value, along with the maximum allowed current, is displayed in the PARAMETERS area of the display.

With the output connected, you can adjust the resistance value with the rotary knob or numeric keypad. Any new values set through the front panel take approximately 500 ms to appear on the output terminals. If during the adjustment, the current or voltage exceeds acceptable limits, the output terminals will be disconnected and an error message is displayed. If the set value should exceed the upper range limit or lower range limit, the Calibrator displays “Value too Large” or “Value too Small” respectively.

Using the Ground Bond Resistance Open Function

There are no special parameters for the Ground Bond Resistance function. To select an open condition on the terminals:

1. If not already selected, press **Z_{GND}** to select the Ground Bond Resistance function.
2. Press the softkey labeled **MODE**.
3. Using the cursor keys or rotary knob, highlight Open and either press the **Select** softkey or press in on the rotary knob.

OPEN should appear in the display as the output condition. To leave the OPEN terminal condition, select either the RESISTANCE or TRANSFER modes of operation using the setup menu key process.

Using the Ground Bond Resistance Transfer Mode

To properly calibrate ground bond resistance meters that require high accuracy resistance measurements below 500 milliohms, use the Calibrator's Transfer Ground Bond Resistance function. Measurements at these low values make it important to compensate for test lead resistance and test connection resistance between the Calibrator and the UUT. To minimize these lead connection problems, a 5320A Transfer Load (GBR) Adapter is used at the input of the Calibrator.

As shown in Figure 4-7, the GBR adapter connects the UUT to both the ZGND output terminals and the Calibrator's voltage and current meter terminals. Measurement is selectable between the ac or dc test signals of the UUT. From these measured values, the calibrator calculates real resistance value at the terminals of the Calibrator.

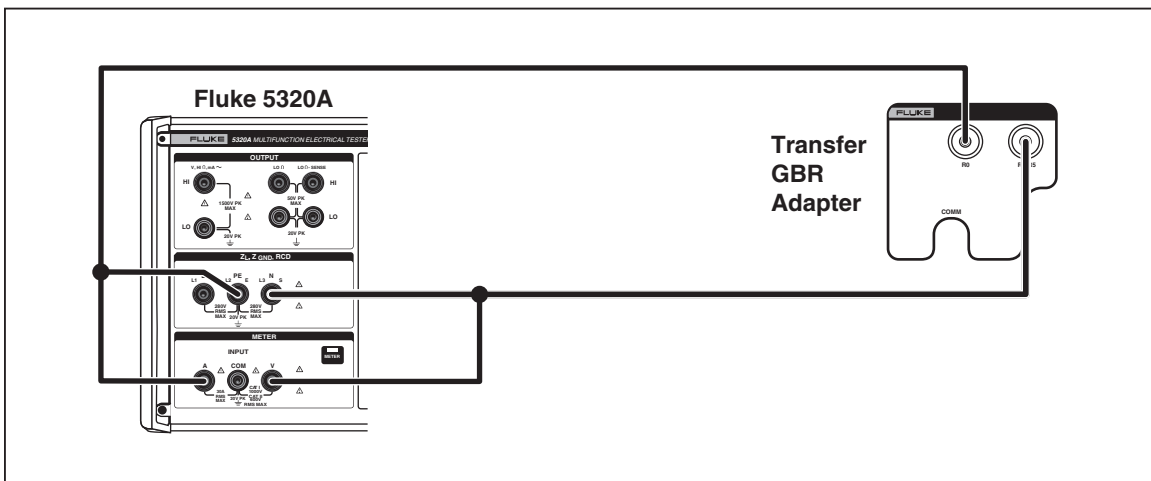

Figure 4-7. Ground Bond Resistance with Transfer Load Adapter

ehq093.eps

To select the Transfer Ground Bond Resistance mode:

1. If not already selected, press **ZGND** to select the Ground Bond Resistance function.
2. Press the softkey labeled MODE.
3. Using the cursor keys or rotary knob, highlight Transfer and either press the Select softkey or press in on the rotary knob.

As shown in Figure 4-8, **Transfer GBR** should appear in the display as the output condition. Use the **Nom R** softkey to select the desired nominal resistance of 0, R1 through R5. Use the **Clear** softkey to reset the displayed maximum and minimum measured test current values. Use the **AC/DC** softkey to select the type of source current supplied from the Ground Bond resistance meter being calibrated.

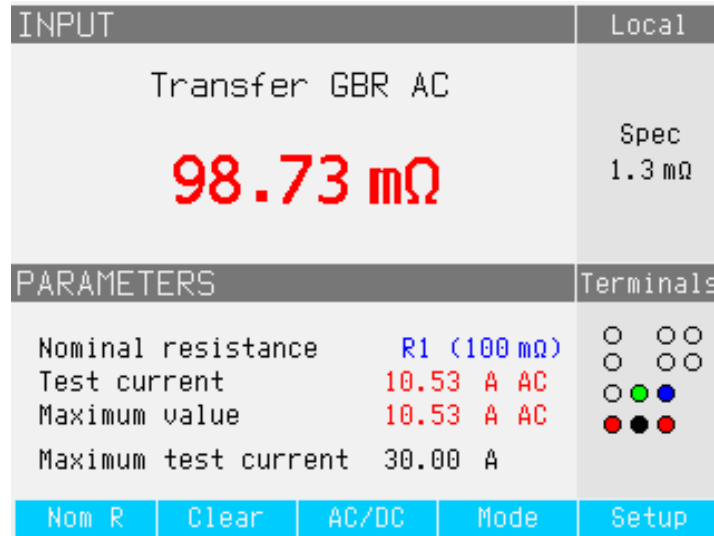

ehq090.bmp

Figure 4-8. Transfer Ground Bond Resistance Display

Using the Loop and Line Impedance Function

For calibrating loop and line impedance functions of loop testers and multifunction installation testers, the Calibrator connects a resistance from 25 mΩ to 1.8 kΩ between its output terminals and either the mains neutral or protective earth power connection. Table 4-3 lists the 16 selectable resistance settings along with their maximum current and voltage ratings.

Setting the output for loop impedance calibration is almost identical to that for line impedance. The only difference is the connection between the UUT and the Calibrator.

For line impedance calibration, the resistance is inserted between the N terminal on the front panel and the Neutral of the power line input on the rear panel. A calibrated resistance is created using the selected resistance in series with the real residual line impedance in the power line socket and the resistance of the power line cable.

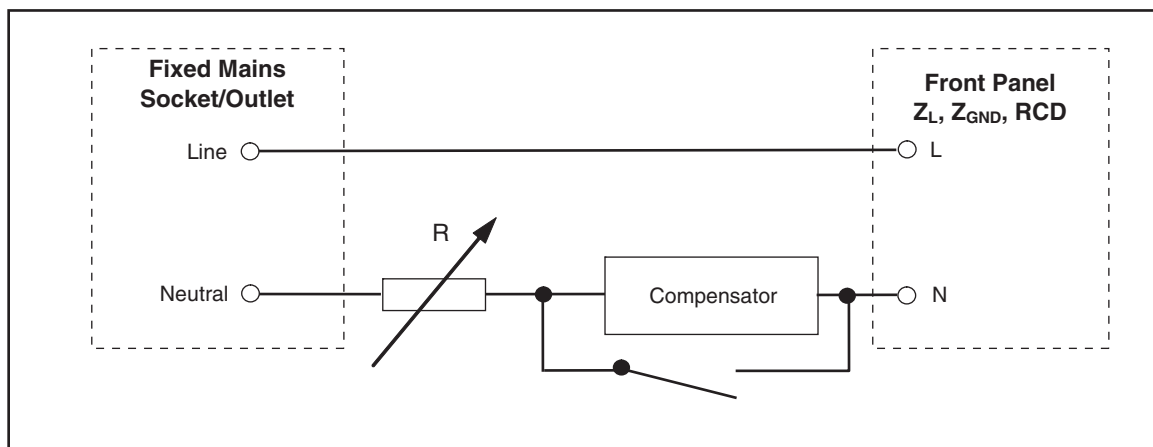

ehq013.eps

Figure 4-9. Simplified Line Impedance source Schematic

For loop impedance calibration, the resistance is inserted between the PE terminal on the front panel and PE (protective earth ground) of the power line input on the rear panel. During a loop impedance calibration, test current flows from the L wire in the mains to

the PE terminal. Loop impedance calibration will not trip a protected circuit unless the test current of the UUT is higher than the nominal trip current of the installed residual current device (current breaker).

Calibrated resistance is created using the selected resistance in series with the real residual loop impedance in the power line socket and power line cable.

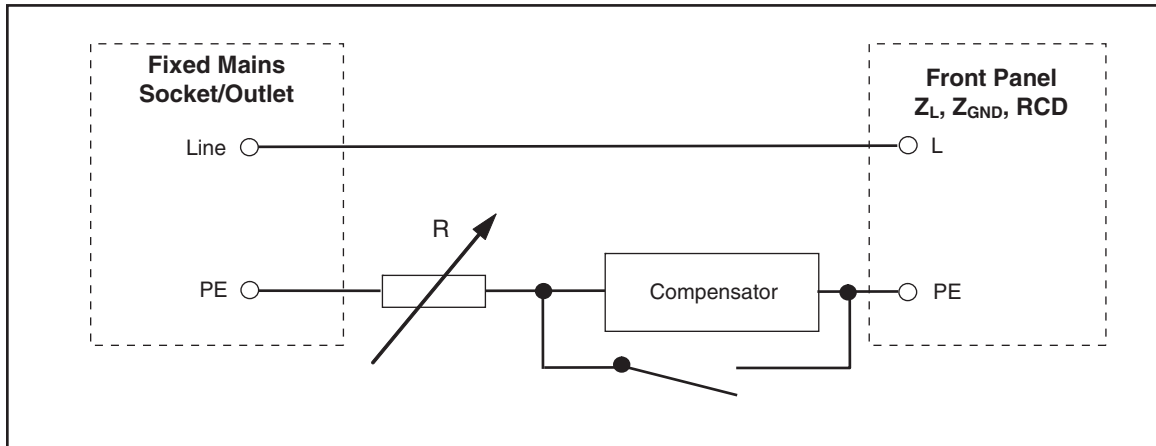

Figure 4-10. Simplified Loop Impedance Source Schematic

ehq014.eps

To set the Loop or Line Impedance Output:

1. Press **[Z_L]**.
2. If the displayed function is not the desired function, press the **Mode** softkey.
3. Using the cursor keys or rotary knob, highlight either **Loop** or **Line** and either press **Select** or press in on the rotary knob.

The value retained from the last time of use is displayed in the output area of the display.

4. Change the resistance value using the rotary knob or the keypad. If the keypad entered value is not exactly one of the 16 possible selections, the resistance closest to the entered value will be selected.

⚠️⚠️ Warning

To avoid electric shock, ensure the Calibrator is in standby before making connections to the L, PE and N connectors. Lethal voltages exist on these terminals during loop and line impedance calibration.

5. With the TERMINALS section of the display as a guide, connect the UUT's terminals to the Calibrator's terminals. The resistance for the Line Impedance function is applied to the L and N terminals of the Z_L , Z_{GND} , and RCD output terminals. For Loop Impedance, the resistance is applied to the L and PE terminals.
6. After confirming that the settings and connections are correct, press **[OPER]** to connect the UUT to mains voltage with the selected resistance.

While connected to the UUT, the Calibrator monitors the voltage and current appearing across the resistance. The actual current flowing in the resistance is displayed in the PARAMETERS area of the display. In addition to actual current, the polarity of the test

signal generated by the UUT, the Prospective Fault Current (PFC), and the mode of residual impedance correction are displayed in the PARAMETERS area of the display.

The polarity of the UUT signal is identified as fullwave (\wedge or \vee), positive ($\wedge-$) or negative ($\vee-$). The prospective fault current is computed by measuring the actual ac voltage on the output terminals, and then multiplying it by the residual resistance calibration value.

Note

The displayed resistance value appears at the Calibrator's terminals. It does not include test lead resistance or contact resistance between the UUT and the Calibrator terminals.

With the output connected, adjust the resistance value using the rotary knob or numeric keypad. Any new values set through the front panel take approximately 500 ms to appear on the output terminals. If the set value should exceed the upper range limit or lower range limit, the Calibrator displays "Value too Large" or "Value too Small", respectively.

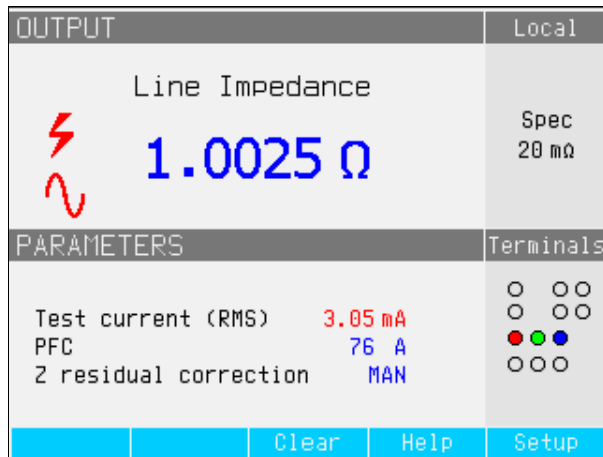

ehq025.bmp

Figure 4-11. Line Impedance Calibration Display

Line and Loop Residual Impedance

While calibrating loop and line impedance functions, the Calibrator uses its ac line power circuit as part of the measurement. The impedance of this branch circuit can cause a significant amount of undetermined impedance in calibration. Therefore, it is important to ensure the mains circuit of the Calibrator has the lowest possible impedance.

Residual impedance is that impedance sensed at the power input socket of the Calibrator. Residual line impedance is the impedance found between the line (L) and neutral (N) wires, while loop impedance is the impedance between the line (L) and ground (PE) wires.

Note

The actual residual impedance of the Calibrator and the power circuit to which it is connected is used in the calibration process for the loop and line impedance calibration. Therefore, this impedance sets the lowest impedance value and becomes the "zero" point for calibrating UUTs.

To ensure the best quality and stability of calibration:

- Use only the power cord supplied with the Calibrator.

- Ensure the power outlet makes good contact with the Calibrator's power cord.
- Have qualified service personnel ensure the branch circuit wire connections to the power outlet are tight.
- Never use extension cords or power strips to power the Calibrator.
- Because residual impedance can be affected by other electrical devices attached to the same branch circuit as the Calibrator, move these devices to other circuits.

Note

During a loop residual impedance test, internal test current flowing between the L and N mains wires is approximately 2.5 A. Both line and loop residual impedance tests can be performed on a protected network.

Selecting the Residual Impedance Correction Mode

To make accurate line and loop impedance calibrations, the actual line and loop impedance of the power mains connection of the Calibration must be taken into consideration. To do this, the Calibrator uses one of three methods of compensation for the residual impedance present at the power inlet. Two methods are available with the standard instrument, and a third method is available with the optional 5320A/VLC configuration.

When doing these tests, the displayed resistance value is the sum of the selected resistance plus any line or loop compensation. Without compensation only the selected resistance is displayed. The first is a manual correction of the residual impedance. The residual impedance can be added to the calibration value manually. The displayed value is the sum of the selected resistance and the manually entered value. The second method uses an internal circuit that scans the residual impedance, saves the value, and then adds it to the selected resistance value. The displayed value is the sum of the selected resistance and the value determined by the scanning process.

A third method (5320A/VLC only) uses an internal electronic compensation circuit to effectively eliminate the actual residual impedance in the power mains circuits of the Calibrator from the impedance measured by the UUT. In this way the UUT measures just the selected Calibrator resistance value. This compensation circuit is limited to 25 A peak of UUT current. If these values are exceeded, the compensation block is disconnected and the compensation mode set to OFF. The maximum impedance compensation depends on the load current, typically 2 Ω at low-level testing.

Separate loop and line residual impedance correction values are stored in the Calibrator using the following methods.

To select the residual impedance correction mode:

1. Press the **Setup** softkey.
2. Select either **Loop Impedance** or **Line Impedance**.
3. Using the cursor keys or rotary knob, highlight **Line imp. compensation** (or **Loop imp. compensation** for Loop impedance function) and either press the **Select** softkey or press in on the rotary knob.
4. Using the cursor keys or rotary knob, highlight **OFF**, **MAN**, **SCAN** or **COMP**, and then press the **Select** softkey or press in on the rotary knob.

OFF – No compensation is used.

MAN – Adds the user defined residual impedance to the selected resistor.

SCAN – Measures the residual impedance and adds it to the selected resistor value.

COMP – Measures the value and electronically subtracts out this residual impedance by inserting a negative resistance at the input.

5. Press the **Exit** softkey repeatedly to return to the main screen.

Setting the Manual Residual Impedance Correction Value

To manually enter the residual impedance correction value:

1. Press the **Setup** softkey.
2. Select either **Loop Impedance** or **Line Impedance**.
3. Using the cursor keys or rotary knob, highlight **Line imp. MAN value** (or **Loop imp. MAN value** for Loop impedance function) and either press the **Select** softkey or press in on the rotary knob.
4. Using the keypad, cursor keys and/or rotary knob, enter the desired residual impedance correction value.
5. After confirming the correct value is in the display, press the **Write** softkey to enter the correction value into the calibration. To exit without changing the value, press the **Exit** softkey.
6. Press the **Exit** softkey repeatedly to return to the main screen.

Note

The maximum residual impedance correction value that can be entered manually is between 0 and 10 Ω .

To use this manually entered value, you must select the manual residual impedance compensation mode as described in the “Selecting the Residual Correction Mode” section earlier in this chapter. When the Residual Impedance Correction mode is set to MANUAL, the stored manual value entered in this section is added to the selected loop or line impedance value and their sum displayed as the calibration value.

Setting the Scanned Residual Impedance Correction Value

The Calibrator has a built-in circuit for measuring the actual residual impedance. The SCAN function provides a residual impedance value that not only includes the power line socket, but the power line cord impedance, the appliance entry contact resistance, and some of the interconnection inside the Calibrator. The lowest residual line or loop impedance is limited by the Calibrator’s measured residual line or loop impedance. The measured residual impedance is added to the selected resistor value.

Note

If the loop or line residual impedance exceeds 10 Ω , an error message is displayed and the scan mode is turned off.

To SCAN for a residual impedance correction value:

1. Press the **Setup** softkey.
2. Select either **Loop Impedance** or **Line Impedance**
3. Using the cursor keys or rotary knob, move the cursor to **Line imp. SCAN value** (**Loop imp. SCAN value** for Loop impedance function) and either press the **Select** softkey or press in on the rotary knob.

The Calibrator automatically measures the residual impedance without connecting the front-panel connectors and stores the value. The SCAN impedance value cannot be entered manually.

Note

The Calibrator scans residual Line and Loop impedance only as a symmetrical parameter, that is, both positive and negative half-wave configurations are measured and the average value displayed.

Note

When the SCAN function is used in the Loop or Line impedance mode, 2.5 amps of current flows between the L and N mains wires. Therefore, this function can be used on mains with residual current circuit breakers.

4. Using the cursor keys or rotary knob, highlight **Loop imp. correction** and either press the **Select** softkey or press in on the rotary knob.
5. Using the cursor keys or rotary knob, highlight **SCAN** and either press the **Select** softkey or press in on the rotary knob.
6. Press the **Exit** softkey repeatedly to return to the main screen.

To use this scanned value, you must select the SCAN or COMP residual impedance compensation mode as described in the *Selecting the Residual Correction Mode* section earlier in this chapter. When the Residual Impedance Correction mode is set to SCAN, the stored scanned value measured in this section is added to the selected loop or line impedance value, and their sum displayed as the calibration value.

Note

Line residual impedance and Loop residual impedance corrections are two different and distinct values and are applied based on which correction mode is selected. Loop impedance calibration is performed on the L and PE mains wires from which the Calibrator draws power. Line impedance calibration is performed on the L and N mains wires.

When the residual line or loop impedance compensation is set to SCAN, the Calibrator performs a SCAN measurement of these two impedances during its power up cycle.

Setting the Compensation Residual Impedance Correction Value

The Calibrator has a compensation circuit to electrically compensate for residual impedance. The compensation circuit is limited in test current amplitude and length of measurement. The maximum test current generated by the UUT has to be less than 25 A and 1,500 ms in duration. The Calibrator will disconnect the compensation mode when overloaded and automatically set the correction mode to OFF. The maximum compensation is 2 Ω . To select the compensation method of residual impedance correction:

1. Press the **Setup** softkey.
2. Using the cursor keys or rotary knob, move the cursor to **Line imp. COMP value (Loop imp. COMP value** for Loop impedance function) and either press the **Select** softkey or press in on the rotary knob.

The Calibrator measures the residual impedance and the compensator uses the measured value to set the compensation circuit.

3. Press the Exit softkey repeatedly to return to the main menu.

To use this compensation mode, select the COMP residual impedance compensation mode as described in the “Selecting the Residual Correction Mode” section earlier in this chapter. When the Residual Impedance Correction mode is set to COMP, the stored scanned value is used to set the compensation circuit parameters to electronically zero the

actual residual impedance. Only the selected loop or line impedance value is displayed on the screen during a calibration.

Performing Leakage Current Calibration

The Calibrator employs four leakage current modes: passive leakage current, active leakage current, differential leakage current, and substitute leakage current. Active leakage current is only available with the 5320A/VLC models.

To select a leakage current mode:

1. Press **mA~**.
2. If the desired leakage current mode is not displayed, press the **Mode** softkey.
3. Using the cursor keys or rotary knob, highlight the desired selection (Passive, Substitute, Differential, or Active) and either press **ENTER** or press in on the rotary knob.

The primary difference between passive leakage current and substitute leakage current is the voltage used during the calibration. Passive leakage uses the line voltage of the UUT. Substitute leakage current uses voltages in the range of 30 to 35 volts.

Calibrating Passive Leakage Current

For passive leakage current calibration, the Calibrator presents a passive variable resistance on the OUTPUT HI and LO connectors. When connected to the Calibrator, the UUT applies a voltage to this resistance and the Calibrator displays the current flowing through the resistance. Figure 4-12 shows the simplified calibrator circuit for this function.

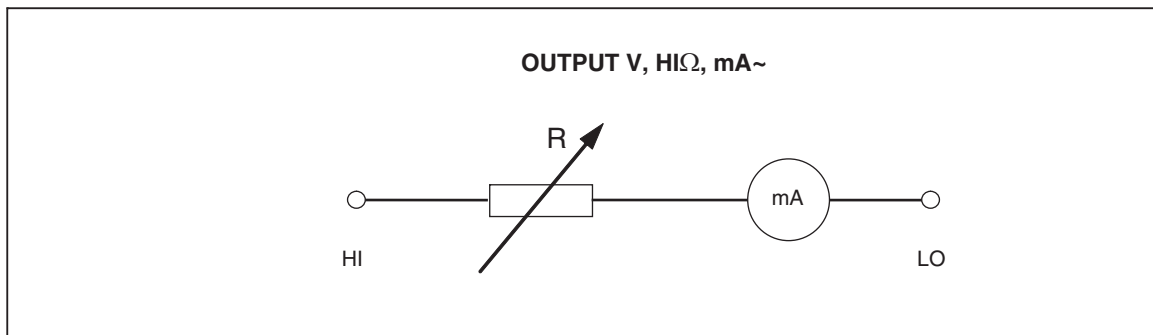

Figure 4-12. Simplified Passive Leakage Current Schematic

ehq015.eps

The Calibrator's internal ammeter measures the current flowing from the UUT's source terminal (L) to its protected earth (PE) terminal. The Calibrator's leakage current range is 0.1 to 30 mA, with an external applied voltage from 25 V to 250 V ac or dc.

Before Passive Leakage Current calibration can be performed, a nominal leakage current must be entered. To enter a nominal leakage current (I_d nom):

1. Press the **Id nom** softkey.
2. Using the keypad, type in the nominal leakage current.

Note

The softkeys can be used to select the units multiplier of A, mA or μ A instead of the exponent key (**EXP**).

3. Press ENTER.

Note

The measured current may be different than the entered nominal current by up to $\pm 10\%$, depending on power supply voltage and set nominal value.

Note

If the UUT is not connected to the Hi and LO terminals of the Calibrator, an “Output/Input overload” message is displayed. This same message is displayed if the LC fuse is open.

To start a Passive Leakage Current calibration:

1. Press mA~.
2. If **Passive Leakage Current** is not already displayed, press the **Mode** softkey.
3. Using the cursor keys or rotary knob, highlight the **Passive** selection and either press the **Select** softkey or press in on the rotary knob.
4. Referring to the terminals part of the display, connect the UUT to the Calibrator.
5. Press the START button on the UUT.
6. Press OPER to start the calibration process.

The Calibrator monitors the input connectors for voltage. When a voltage in the acceptable range is detected, the Calibrator switches in a resistance to start current flow. The Calibrator has a settling time (typically 3 seconds) to adjust the resistance for a current value that matches the nominal current set on the Calibrator. If the voltage is too low or none existent, the Calibrator displays an error message.

The “Test voltage too low” message is also displayed when the LC fuse is open.

Note

The captured main leakage current simplifies calibration of testers that measure leakage current for a limited time of just several seconds. Even after the test current is removed from UUT, the main leakage current remains in the display.

During passive leakage current calibration, the display indicates the captured leakage current flowing in the UUT 2 to 3 seconds after the Calibrator senses the correct voltage on the inputs. Until the correct voltage is detected, the primary display indicates “----”. The PARAMETERS area of the display shows nominal current entered through the setup menu and continuous current flowing through the UUT. Both continuous and captured current values are rms (ac+dc) values.

Calibrating Differential Leakage Current

For differential leakage current, the Calibrator sinks preset leakage current flowing from the UUT to the PE terminal, which results in an unbalance between current flowing from the UUT’s line terminal and the returning current flowing to the UUT’s neutral terminal. The UUT detects this current difference and displays it as differential leakage current.

The Calibrator works as a variable resistance load with a milliammeter in series. Test voltage is generated by the UUT. Differential leakage mode differs from the passive leakage current mode in the connection of the UUT to the Calibrator. The simplified schematic for differential leakage current is identical to that for passive leakage current show in Figure 4-12.

Calibrating Active Leakage Current (5320A/VLC only)

The active leakage current calibration mode is for UUTs lacking their own test voltage source. This function is only available with 5320A/VLC models.

Unlike passive, substitute, and differential leakage current modes for which the Calibrator acts as a resistance decade, the Calibrator acts as a current source for the UUT in the active current mode. The current source can have a maximum voltage between 50 and 100 volts. Therefore, as a reminder to the user that voltage will be present at the output terminals during the calibration, the message shown in Figure 4-14 is displayed whenever the active leakage current mode is selected.

As figure 4-13 shows, the voltage source, a resistance, and ammeter are connected in series with the output connectors.

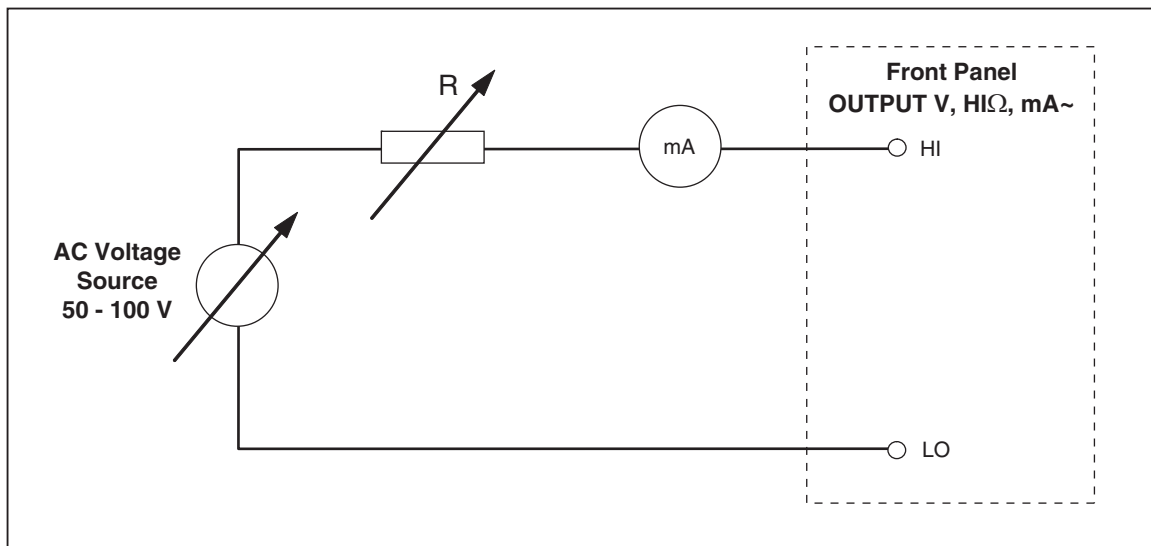

Figure 4-13. Simplified Active Leakage Current Scheme

ehq016.eps

To perform an active leakage current calibration:

⚠ ⚠ Warning

To avoid electric shock, keep hands away from Calibrator terminals while using active leakage current mode. AC voltage is used for active leakage current calibration.

1. Press **mA~**.
2. If **Active Leakage Current** is not already displayed, press the **Mode** softkey.
3. Using the cursor keys or rotary knob, highlight the **Active** selection and either press the **Select** softkey or press in on the rotary knob. The warning message shown in Figure 4-14 will be displayed.

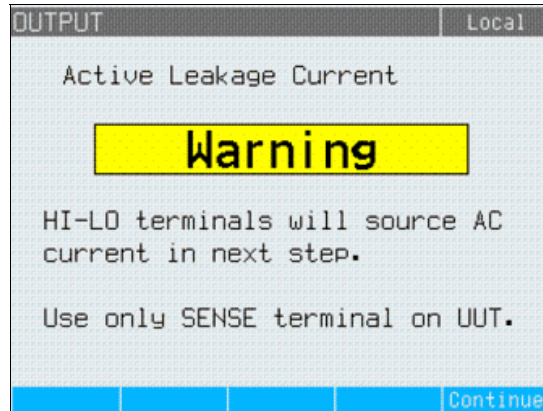

ehq060.bmp

Figure 4-14. Active Leakage Current Warning Message

4. Press the Continue soft key
5. If not already set correctly, enter the nominal current value by using the keypad and softkeys, or rotary knob to enter a nominal current value.
6. If the rotary knob is used to change the current value, press **Exit** to go back to the main screen.
7. Referring to the terminals part of the display, connect the UUT to the Calibrator.
8. Press **OPER** to start the calibration process.

The Calibrator adjusts the source voltage and resistance to get the UUT current as close to the requested current as possible. This process takes about 2 seconds. The Calibrator can only create an ac current with a frequency equal to that of the mains supplying power to the Calibrator (50 or 60 Hz).

Substitute Leakage Current Mode

The substitute leakage current method, often used in Appliance testers, uses a safe low level test voltage instead of power line voltage. The UUT measures the leakage current flowing at its SENSE terminal. This current is used to calculate what the current would be at the nominal power line voltage. This recalculated current is displayed for the leakage current value.

The Calibrator works as a simple variable resistance. Using the nominal leakage current and known nominal voltage in the power line, the calibrator calculates the appropriate resistance using the following formula:

$$R = V_{nominal} / I_{nominal} - R_{out}$$

$I_{nominal}$ is the nominal leakage current set by the user.

After calculating the resistance, the Calibrator connects the resistance to the output terminals.

To start a substitute leakage current calibration:

1. Press **mA~**.
2. If **Substitute Leakage Current** is not already displayed, press the **Mode** softkey.
3. Using the cursor keys or rotary knob, highlight the **Substitute** selection and either press the **Select** softkey or press in on the rotary knob.
4. If necessary, either use the rotary knob or keypad to change the current value.

5. Referring to the TERMINALS area of the display, connect the UUT to the Calibrator.
6. Press the START button on the UUT.
7. Press **OPER** to start the calibration process.

Note

“Test voltage too low” message is displayed if the test voltage is less than 10 volts or the LC fuse is open.

8. When the Calibrator is finished with the calibrating process, press **STBY** to disconnect the output terminals.

Figure 4-15 shows the resistor connected to OUTPUT HI – LO terminals.

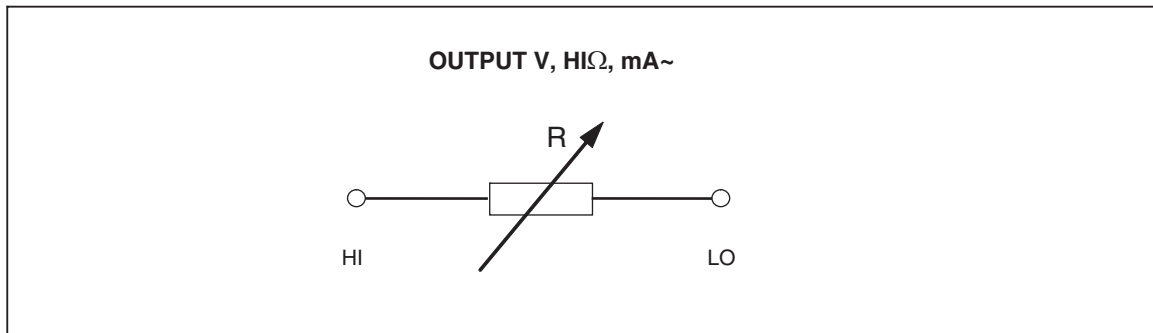

Figure 4-15. Simplified Substitute leakage current schematic

ehq011.eps

The Calibrator does not actually measure leakage current in this mode.

The substitute leakage current is defined by the nominal power line voltage (115 or 230 V), the nominal leakage current set through Id nominal, and the output resistance of UUT source terminal (R_{OUT}). Usually the R_{OUT} parameter is 2 kΩ to simulate human body resistance. The R_{OUT} parameter can be set between 0 and 5 kΩ through the setup menu.

Note

The R_{OUT} parameter significantly influences the accuracy of the substitute leakage current calibration. Some Appliance testers are designed with output resistance values different than 2 kΩ. Check the UUT's operation manual before performing this calibration.

To set the R_{OUT} parameter:

1. Press the **Setup** softkey.
2. Using the cursor keys or rotary knob, highlight **Leakage Current** and either press the **Select** softkey or press in on the rotary knob.
3. With the cursor on **Substitute LC Rout** press the **Select** softkey or press in on the rotary knob again to set the value.
4. Using the keypad, cursor keys or rotary knob, change the value to the desired resistance.
5. Press the **Write** softkey to store the new value. To exit without changing the value, press **Exit**.
6. Press **Exit** repeatedly to return to the main screen.

Calibrating RCD Test Functions

The Calibrator's Residual Current Device (RCD) function is used to calibrate the RCD function of RCD testers and multifunction installation testers. The calibration process checks the installation tester's RCD trip current and trip time settings by emulating a circuit breaker with adjustable trip current and trip time. The Calibrator has a trip current range of 10 mA to 3000 mA in 1 mA steps. Its trip time range is 10 ms to 5 seconds. Figure 4-16 shows the Calibrator's basic configuration when performing RCD calibration.

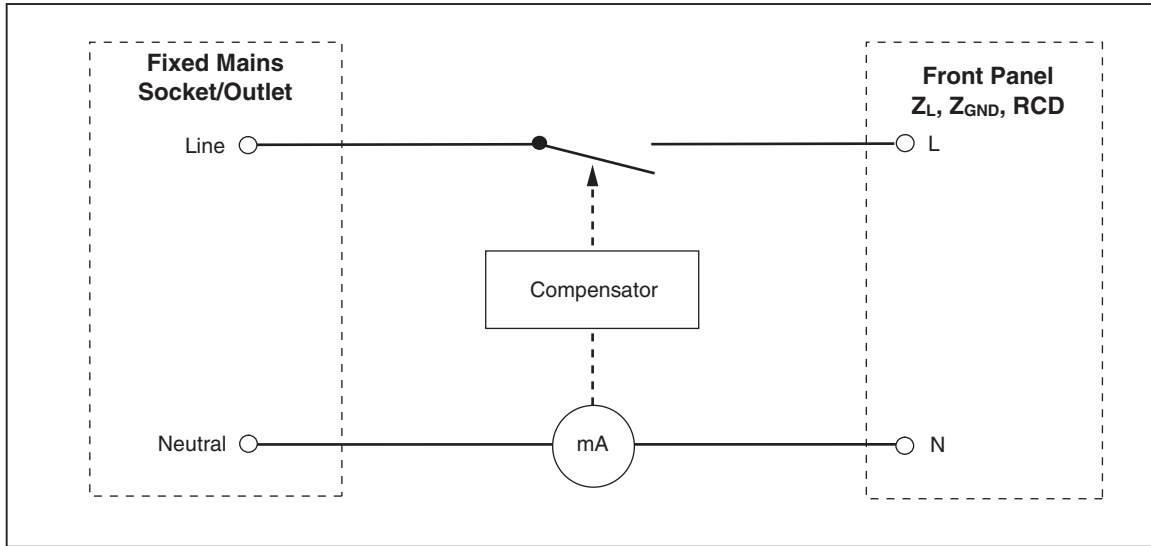

Figure 4-16. Simplified RCD Scheme

ehq018.eps

Calibrating RCD Trip Current Function

RCD Trip Current calibration is performed by the Calibrator monitoring current from the UUT and displaying the measured current when it reaches the nominal set value. The output terminals are also disconnected when the trip current level is reached. Typically UUT trip current increments from 30 to 150 % of the nominal trip current in steps of several percent.

Note

The incremental step level for RCD Trip current from a UUT depends on the manufacturer's design and lies between 2 and 10 % per step. Full wave or pulse trip current may be used depending on the UUT.

To perform an RCD Calibration:

1. Press RCD.
2. If RCD Trip Current is not already displayed, press the **Mode** softkey.
3. Using the cursor keys or rotary knob, highlight the **Trip Current** selection and either press the **Select** softkey or press in on the rotary knob.

The last nominal trip current and the series resistance settings are displayed in the PARAMETERS area of the display. If the nominal trip current setting needs to be changed, see "To change the nominal trip current" section below. If the series

resistance setting needs to be changed, see “To change the series resistance” section below.

⚠⚠ Warning

To avoid electric shock, ensure the Calibrator is in standby while making connections to the L and N connectors. Lethal voltages are present on the L and N connectors during RCD Trip Current calibration.

4. Referring to the terminals part of the display, connect the UUT to the Calibrator.
5. Press **OPER** to start the calibration process.
6. Press Start on the UUT.

When the level of test current flowing from the UUT reaches the set nominal trip current value, the Calibrator starts to measure current amplitude. The measuring process lasts for several power line cycles. The Calibrator simulates tripping of a breaker by disconnecting the output connectors and displays the measured trip current.

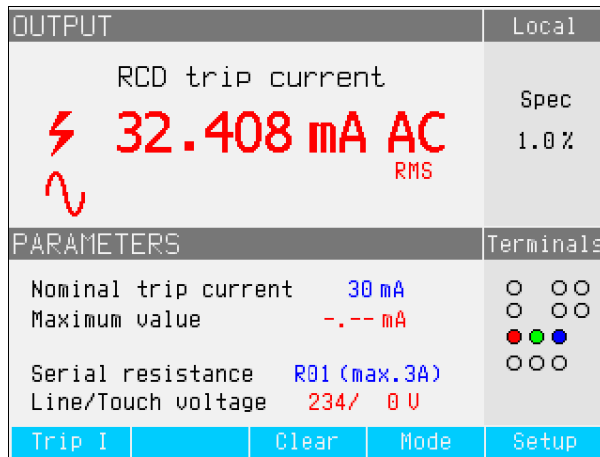

ehq65.bmp

Figure 4-17. RCD Trip Current Display

The Calibrator displays the following information for an RCD trip current calibration:

UUT test signal polarity is indicated with one of the following graphic icons:

- Positive symmetrical ac current (SYMP)
- Negative symmetrical ac current (SYMN)
- Positive pulse of dc current (POS)
- Negative pulse of dc current (NEG)
- dc current with positive polarity (DCP)
- dc current with negative polarity (DCN)

If the signal cannot be recognized, then “Not recognized” is displayed. If a negative dc test current is detected, a “NEG” symbol is displayed. If a positive dc test current is detected, a “POS” symbol is displayed. Phase is not displayed for dc sensitive signals.

- Measured trip current as an rms value.
- Power/Touch voltage

Power Line Voltage

The Calibrator measures the power line voltage as a first step in the tripping procedure. This voltage is measured after the output terminals are switched on.

Touch (contact) Voltage

Touch voltage is the voltage difference between N and PE potentials. UUTs can usually measure this voltage and display it as a measured value or detect crossing over the safe voltage level (25 to 50 volts typical) with an indication of this event. Touch voltage generated by the Calibrator depends on selected series resistance and setup nominal trip current. It is scanned and displayed in this field.

To change the nominal trip current:

1. Press the **Trip I** softkey.
2. Using the keypad, type in the desired nominal trip current value and press ENTER.

Note

The Calibrator's nominal trip current can be set between 3 and 3000 mA.

3. Press **Exit** to return to the RCD calibration main screen.

Although the Calibrator selects the most appropriate series resistance for RCD calibration, you can manually select one of sixteen resistance values to adjust RCD calibration performance. To change the series resistance:

1. Press the **Setup** softkey.
2. Using the cursor keys or rotary knob, highlight the **RCD** selection and either press the **Select** softkey or press in on the rotary knob
3. Using the cursor keys or rotary knob, highlight **Series resistance** and either press the **Select** softkey or press in on the rotary knob.
4. Using the cursor keys or rotary knob, highlight the desired resistance and either press the **Select** softkey, or press in on the rotary knob. Table 4-4 lists the available series resistance selections.
5. Press the **Exit** softkey several times to return to the RCD calibration main screen.

Table 4-4. Series Resistance Values

Resistor Label	Resistor Value
R01	0.025 Ω
R02	0.05 Ω
R03	0.1 Ω
R04	0.33 Ω
R05	0.5 Ω
R06	1 Ω
R07	1.8 Ω
R08	5 Ω
R09	10 Ω
R10	18 Ω
R11	50 Ω

Table 4-4. Series Resistance Values (cont.)

Resistor Label	Resistor Value
R12	100 Ω
R13	180 Ω
R14	500 Ω
R15	1 kΩ
R16	1.8 kΩ

Calibrating RCD Trip Time

RCD Trip Time calibration is performed by the Calibrator monitoring current from the UUT and disconnecting the output terminals after the current reaches the trip current level for the specified trip time. In addition to the measured UUT trip current, the Calibrator displays the Power/Touch voltage. Figure 4-18 shows the Calibrator's RCD trip time process.

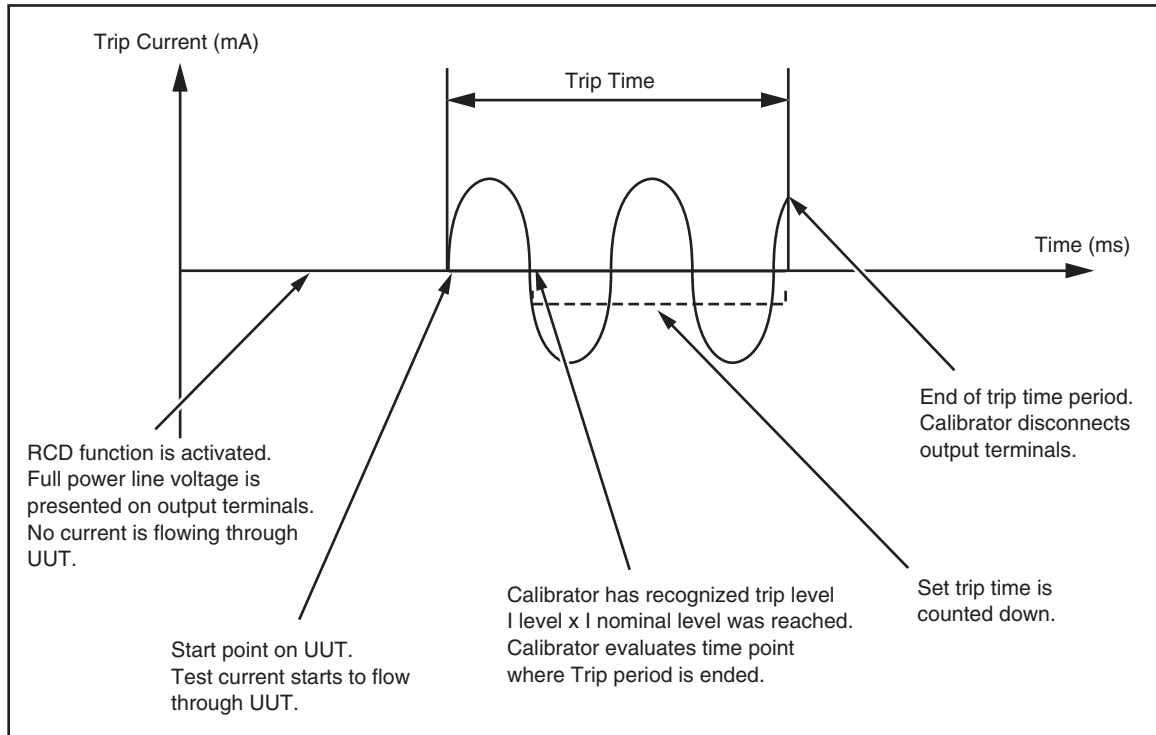

Figure 4-18. RCD Trip Time Process

ehq019.eps

To perform an RCD Trip time calibration:

1. Press **RCD**.
2. If RCD Trip Time is not already displayed, press the **Mode** softkey.
3. Using the cursor keys or rotary knob, highlight the **Trip Time** selection and either press the **Select** softkey or press in on the rotary knob.

Parameters which are set through the front panel are nominal trip current, current multiplier, current level and series resistance. To set one of these parameters, see the appropriate section below.

4. If the displayed trip time is not the desired time, use the cursor keys, keypad or rotary knob to set the desired trip time. Trip time range is 10 ms to 5 seconds.

⚠⚠ Warning

To avoid electric shock, ensure the Calibrator is in standby while making connections to the L and N connectors. Lethal voltages are present on the L and N connectors during RCD Trip Current calibration.

5. Referring to the terminals part of the display, connect the UUT to the Calibrator.
6. Ensure the nominal trip current and the current multiplier value on the UUT, are equal to the values set in the Calibrator.
7. Press **OPER** to start the calibration process.
8. Press Start on the UUT.

The Calibrator puts power line voltage on the RCD L and N terminals. When start is pressed on the UUT, the UUT's internal load is connected to the Calibrator's connectors. When the measured current reaches a value specified by the product of the nominal trip current and the current multiplier, a timer is triggered. The timer starts at the first zero crossing of the power line voltage before the trip current value was reached. When the time in the timer matches the selected trip time, the output connectors are disconnected and the measured values are displayed.

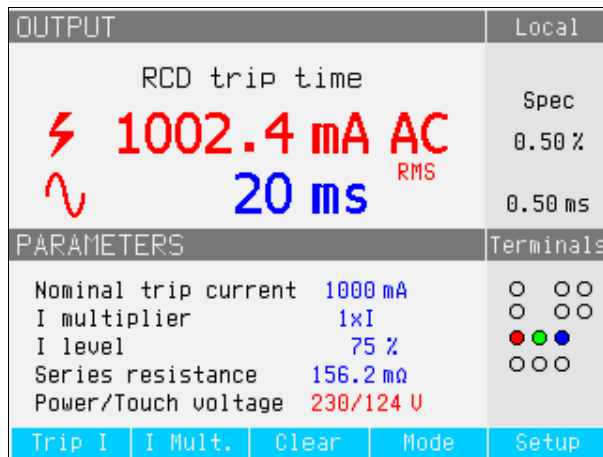

Figure 4-19. RCD Trip Time Display

ehq027.bmp

The Calibrator displays the following for an RCD trip time calibration:

- UUT test signal polarity is indicated with one of the following graphic icons:

- Positive symmetrical ac current (SYMP)
- Negative symmetrical ac current (SYMN)
- Positive pulse of dc current (POS)
- Negative pulse of dc current (NEG)
- dc current with positive polarity (DCP)
- dc current with negative polarity (DCN)

If the signal cannot be recognized, then “Not recognized” is displayed. When the trip time is set to less than 20 ms, only positive and negative polarity are detected. If a

negative dc test current is detected, a “NEG” symbol is displayed. If a positive dc test current is detected, a “POS” symbol is displayed. Phase is not displayed for dc sensitive signals.

- Measured trip current as an rms value.
- Power/Touch voltage

Power Line Voltage

The Calibrator measures the power line voltage as a first step in the tripping procedure. This voltage is measured after the output terminals are switched on.

Touch (contact) Voltage

Touch voltage is the voltage difference between N and PE potentials. UUTs can usually measure this voltage and display it as a measured value or detect crossing over the safe voltage level (25 to 50 volts typical) with an indication of this event. Touch voltage generated by the Calibrator depends on selected series resistance and setup nominal trip current. It is scanned and displayed in this field.

To change nominal trip current:

1. Press the **Trip I** softkey.
2. Using the keypad, type in the desired nominal trip current value and press or use the softkeys to select the appropriate units.

Note

The Calibrator's nominal trip current can be set between 3 and 3000 mA.

3. Press **Exit** to return to the RCD calibration main screen.

Although the Calibrator selects the most appropriate series resistance for RCD calibration, you can manually select one of sixteen resistance values to adjust RCD calibration performance. To change the series resistance:

1. Press the **Setup** softkey.
2. Using the cursor keys or rotary knob, highlight **RCD** and either press the **Select** softkey or press in on the rotary knob.
3. Using the cursor keys or rotary knob, highlight **Series resistance** and either press the **Select** softkey or press in on the rotary knob.

The series resistance is inserted into the test circuit to generate a non-zero touch voltage. One of 16 fixed resistors between 25 mΩ and 1.8 kΩ (labeled R01 to R16) are used for the series resistance setting. The resulting touch voltage can be approximated by multiplying trip current times the series resistance value.

Note

Do not exceed maximum allowed current for the selected resistance. Maximum current is displayed in brackets next to the series resistance in the PARAMETERS area of the display.

4. Using the cursor keys or rotary knob, highlight the desired resistance and either press the **Select** softkey, or press in on the rotary knob. Table 4-4 on page 4-25 lists the available series resistance selections.
5. Press the **Exit** softkey several times to return to the RCD calibration main screen.

To change the current multiplier:

1. Press the **I Mult.** softkey.
2. Press the **I Mult.** softkey for the desired current multiplier value and either press the **Select** softkey or press in on the rotary knob. Available multipliers are 0.5, 1, 1.4, 2, and 5.

0.5 – This setting is used for Installation testers that test non-tripping RCDs. When this value is set, the Calibrator measures UUT trip current for 5 seconds and then disconnects the output terminals. If the UUT current exceeds the set nominal trip current or is greater than 4000 mA, the Calibrator disconnects the output connectors and displays a “Trip current too high” error message.

1 – This setting is the most common for Installation testers. Depending on the I level parameter, the Calibrator may or may not ignore any pretest pulses generated by the UUT which are below the value determined by I level and nominal trip current settings. Pretest pulses are ignored if their level is below the pretest I level value. If the pretest pulses are higher than the I level parameter, the Calibrator reads them as real trip current pulses.

1.4 and 2 – These settings are used for testing UUTs that measure current overloading. The Calibrator’s and UUT’s current multiplier should be set to the same value when calibrating using this setting. These settings multiply the nominal trip current setting by 1.4 or 2 and uses it as the trip point. If the trip current exceeds 300 % of the nominal current setting or 3000 mA, the output terminals are disconnected and a “Trip current too high” error message displayed. The maximum nominal trip current that can be used with this setting is 1500 mA.

5 – This setting multiplies the nominal trip current by 5 and uses that value as the trip current value. If the trip current exceeds 750 % of the nominal trip current setting or 3000 mA, the output terminals are disconnected and a “Trip current too high” error message is displayed. The maximum nominal trip current that can be used with this setting is 600 mA.

Note

Multiplier values of 2 and 5 are for testing of fast tripping RCDs.

To change the current level detection setting:

1. Press the **Setup** softkey.
2. Using the cursor keys or rotary knob, highlight the **RCD** selection and either press the **Select** softkey or press in on the rotary knob
3. Using the cursor keys or rotary knob, highlight **I level** and either press the **Select** softkey or press in on the rotary knob.
4. Using the cursor keys or rotary knob, highlight the desired current level (5, 30, 60, 75, 90, 100, and 120) and either press the **Select** softkey or press in on the rotary knob.
5. Press the **Exit** softkey several times to return to the RCD calibration main screen.

The I level parameter allows the Calibrator to ignore pretest pulses generated by many UUTs. Pretest pulses can be a high as 50 % of the nominal trip current value. This parameter is also used for testing UUTs that generate trip currents less than the nominal trip current. The recommended setting is 90 % and is set as the default value for the current level.

Note

The Calibrator independently evaluates trip current on each half-wave of the measured trip current.

Installation testers can be set for Standard or Sensitive RCDs. Standard RCDs have a trip time range between 10 ms and 500 ms. Sensitive RCDs range between 40 ms and 5 s. Although the Calibrator cannot detect which of these two settings the UUT is set, trip time and trip current can still be calibrated. The Calibrator measures trip current and disconnects the output terminals after the trip time expires.

AC/DC Voltage Calibration (5320A/VLC only)

The Calibrator calibrates instruments and testers with ac and/or dc voltage measurement functions up to 600 V. With a burden current over 150 mA at 230 V, the Calibrator also makes a good stable power source for UUTs like appliance testers.

To perform a voltage calibration:

1. Press .
2. If the Calibrator is not already in the desired mode (ac or dc voltage), press the **AC/DC** softkey.

Note

For ac voltage, the Calibrator only generates a sinusoidal signal.

Warning

To avoid electric shock, ensure the Calibrator is in standby while making connections to the HI and LO connectors. Lethal voltages may be present on the HI and LO connectors during voltage calibration.

3. Referring to the TERMINALS area of the display, connect the UUT to the Calibrator.
4. If necessary, set the output value using the keypad, cursor keys, or rotary knob.
5. After confirming the correct settings and connections, press  to connect the UUT to the selected voltage.

With the voltage applied to the UUT, the voltage setting can be changed using the cursor keys, rotary knob or keypad.

Warning

Whenever the output voltage is above 50 V ac or dc, the ⚡ icon appears in the display. To avoid electric shock, ensure the Calibrator is in standby before touching the output connectors.

6. When finished, press  to remove the voltage from the Calibrator's terminals and UUT.

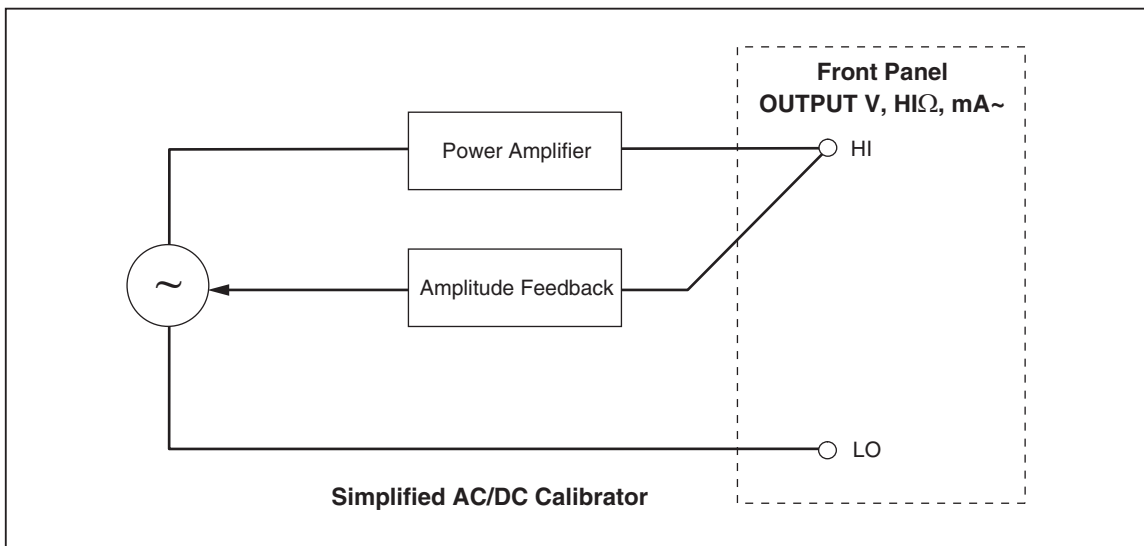

Figure 4-20. Simplified Voltage Calibrator Schematic

In the Voltage calibration mode, the Calibrator’s output is either grounded or ungrounded. When the output is grounded, the Calibrator’s LO terminal is connected internally to PE or the ground connection of the power cable connector and Calibrator chassis. An ungrounded or floating output opens this connection through an internal relay.

Note

The Calibrator has electronic overload protection and disconnects the output terminals when the output current exceeds the maximum allowed current. A current overload message is also displayed when the Calibrator becomes overloaded.

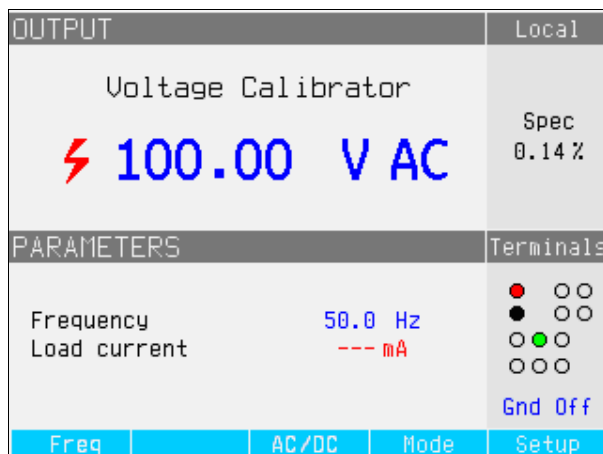

Figure 4-21. AC Voltage Calibrator Display

For ac voltage calibrations, output signal frequency appears in the PARAMETERS area of the Calibrator’s display. The ac voltage frequency range is 40 to 400 Hz.

To set the ac voltage frequency:

1. Press the **Freq** softkey.

Cursor icons appear above and below one of the digits in the frequency display.

2. Use the cursor keys, rotary knob or keypad to set the frequency value.
3. Press the **Exit** softkey to exit the frequency edit mode.

To switch between grounded and ungrounded (floating) output:

1. Press the **Setup** softkey.
2. Using the cursor keys or rotary knob, highlight **Calibrator** and either press the **Select** softkey or press in on the rotary knob.
3. Using the cursor keys or rotary knob, move the cursor to **Output GND** and either press the **Select** softkey or press in on the rotary knob.
4. Using the cursor keys or rotary knob, move the cursor to **GND On** or **GND Off** and either press the **Select** softkey or press in on the rotary knob.
5. Return to the main display by pressing the **Exit** softkey repeatedly.

Measuring with the Built-in Multimeter

The Calibrator is equipped with an ac/dc voltage, current, current leakage, and time interval meter. The meter has three selectable modes as well as a help guide:

- **Multimeter:** The meter will measure up to 1100 volts rms and up to 30 amps rms simultaneously. This makes it possible to measure power consumption and line current simultaneously when calibrating Appliance testers.
- **HIPOT LC:** The meter will simultaneously measure output voltage and leakage current of hipot testers up to 300 mA.
- **HIPOT Timer:** The meter measures the time interval of hipot testers up to 999 seconds.
- **Help:** The help guide offers basic information about the selected function.

The meter's input terminals and function selection button are located in the lower left corner of the front panel (See items 4 and 6 in Table 3-1 of Chapter 3).

Note

When measuring with the built-in multimeter, the meter terminals are always connected. Measurements are taken whether the Calibrator is in standby or operate mode.

Function Selection

To set the meter mode:

1. Press the **Mode** softkey to display the Available Modes menu (see Figure 4-22).
2. Using the cursor keys or rotary knob, highlight the mode.
3. Press the **Select** softkey or press in on the rotary knob to select the highlighted mode.

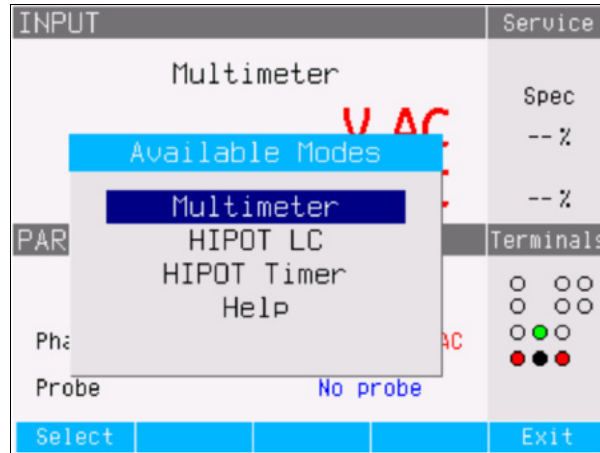

Figure 4-22. Multimeter Mode Selection

ehq66.bmp

Measurements

To make a voltage measurement using the built-in multimeter:

1. Press .
2. If necessary, press the **AC/DC** softkey to select between ac or dc mode.

Caution

To prevent possible damage to the Calibrator, never connect the COM or A connector to the Line (L) terminal of power mains.

3. Connect the test leads to the V and COM jacks.

Note

Whenever a voltage exceeding 50 volts is detected, the ⚡ icon appears in the display.

To make a current measurement using the built-in multimeter:

1. Press .
2. If necessary, press the **AC/DC** softkey to select between ac or dc mode.

Caution

To prevent possible damage to the Calibrator, never connect the COM or A connector to the Line (L) terminal of power mains.

3. Connect the test leads to the A and COM jacks.

Note

Whenever a voltage exceeding 50 volts is detected, the ⚡ icon appears in the display.

The COM connector is the low signal connection for both voltage and current input. The COM connector can be grounded or ungrounded (floating). When ungrounded, the maximum voltage between COM and PE is 20 volts.

When both voltage and current are supplied to the meter's inputs, both readings are displayed in the output area of the display. In addition, a Phantom Power value is calculated and displayed in the PARAMETERS area of the display.

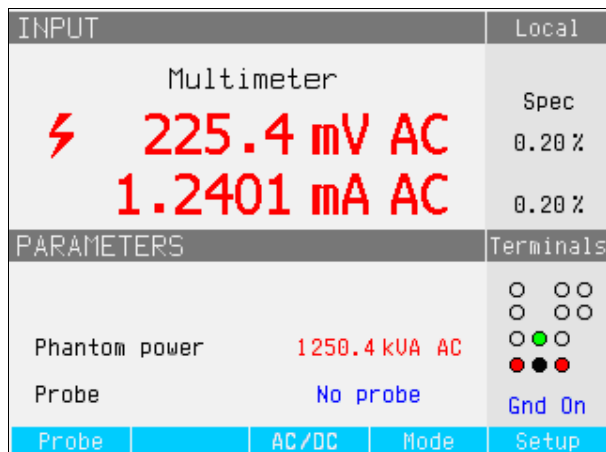

ehq029.bmp

Figure 4-23. Multimeter Display with Current and Voltage

To switch between grounded and ungrounded COM connector:

⚠ Caution

The COM terminal should never be grounded when calibrating Appliance testers that are powered from the power mains and not the Calibrator.

1. Press the **Setup** softkey.
2. Using the cursor keys or rotary knob, highlight **Multimeter** and either press the **Select** softkey or press in on the rotary knob.
3. Using the cursor keys or rotary knob, highlight **Output GND** and either press the **Select** softkey or press in on the rotary knob.
4. Using the cursor keys or rotary knob, highlight either **GND On** or **GND Off** and either press the **Select** softkey or press in on the rotary knob.
5. Return to the multimeter display by pressing the **Exit** softkey repeatedly.

The Calibrator can measure voltages above 1100 volts when used with a high voltage probe (Fluke 80K-40) or the standard accessory, the 10 kV divider/resistance multiplier. Both accessories will divide down the voltage so the multimeter can measure DC voltage or AC voltage with a frequency of 50 or 60 Hz.

To set the Calibrator for use with a probe, press the **Probe** softkey until the desired probe is displayed. There are three choices: No probe, 10 kV, and 40 kV.

The Calibrator can simultaneously measure output voltage and leakage current of hipot testers.

To make a current leakage measurement using the built-in multimeter:

1. Press .
2. Select the **HIPOT LC** mode.
3. If necessary, press the AC/DC softkey to select between ac or dc mode.

⚠ Caution

To prevent possible damage to the Calibrator, never connect the COM or A connector to the Line (L) terminal of power mains.

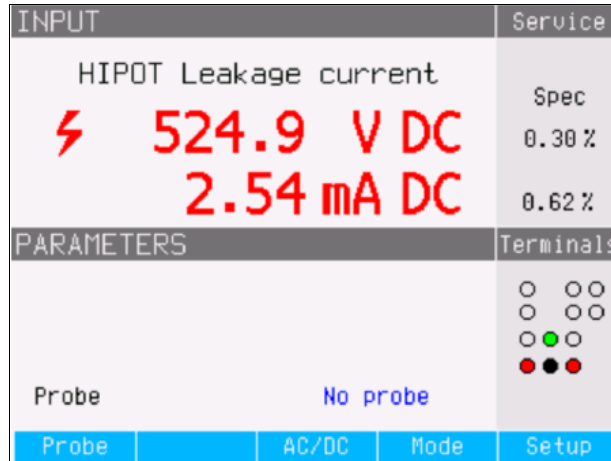

Figure 4-24. Multimeter Display with Hipot Leakage Current Measurement

ehq061.bmp

4. Connect the test leads to the V and COM jacks.

In hipot timer mode, the Calibrator measures the time interval in seconds. To make a hipot timer measurement using the built-in multimeter:

1. Press **METER**.
2. Select the **HIPOT Timer** mode.
3. If necessary, press the AC/DC softkey to select between ac or dc mode.
4. Connect the test leads to the V and COM jacks.
5. Set the hipot UUT to less than 1000V and select a timer mode. Activate the timer mode on the UUT when ready.

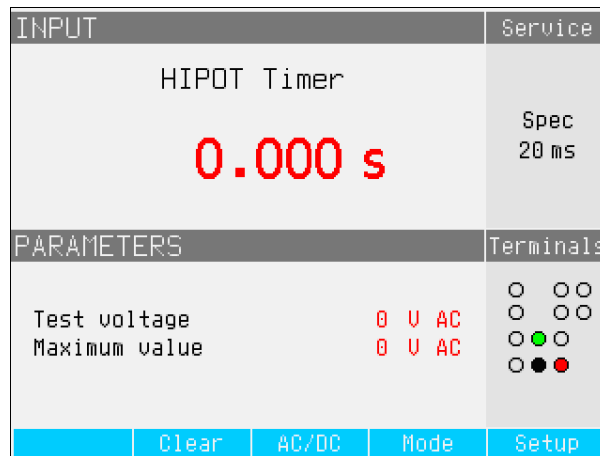

Figure 4-25. Multimeter Display with Hipot Timer Measurement

ehq67.bmp

The current hipot output voltage and its maximum value during the measurement period are displayed in the PARAMETERS area of the display. To clear the time interval measurement, press the Clear softkey.

Note

Uncertainty of displayed time depends on selection of ac or dc mode. In ac mode, uncertainty is determined by the length of one period of hipot output voltage frequency.

⚠ Caution

To prevent possible damage to the Calibrator, do not exceed maximum input voltage of the multimeter (1000 V ac/dc).

Chapter 5

Remote Operation

Title	Page
Introduction.....	5-3
Using the IEEE 488 Port for Remote Control	5-3
IEEE488 Bus Restrictions	5-3
Setting up the IEEE 488 Port.....	5-3
Using the RS-232 Port for Remote Control.....	5-4
Setting up the RS-232 Port.....	5-4
RS-232 Connector Pinout.....	5-5
Exceptions for RS-232 Remote Control.....	5-5
Using the Ethernet Connection for Remote Control.....	5-5
Factory Settings	5-6
Command Syntax Information.....	5-6
Parameter Syntax Rules.....	5-6
Terminators.....	5-7
Numeric Output Format	5-7
Supported SCPI Commands	5-7
Description of Abbreviations	5-8
SCPI Command Summary	5-8
SCPI Command Details.....	5-17
Using the OUTPUT Commands.....	5-17
Using the SOURCE Commands.....	5-17
Using SYSTEM Commands	5-40
Using the STATUS Subsystem	5-42
Using IEEE 488.2 Common Commands.....	5-43
Standard Status Data Structures	5-44
SRE Service Request Enable Register	5-46
ESR Event Status Register	5-46
ESE Event Status Enable Register	5-47
IEEE 488 Interface Configuration.....	5-48

Introduction

This chapter describes methods for operating the Calibrator by remote control. Remote control can be interactive, with the user controlling each step from a terminal, or under the control of a computer program running the Calibrator in an automated system. The Calibrator rear panel has three ports for remote operations: IEEE-488 parallel port, also known as a General Purpose Interface Bus (GPIB port); an RS-232 serial port; and a TCP/IP Ethernet connection. The Calibrator can be controlled through only one communications interface at a time.

Using the IEEE 488 Port for Remote Control

The Calibrator is fully programmable for use on the IEEE Standard 488.1 interface bus. The IEEE-488 interface is also designed in compliance with supplemental standard IEEE-488.2, which describes additional IEEE-488 features. Devices connected to the IEEE-488 bus are designated as talkers, listeners, talker/listeners, or controllers. Under remote control of an instrument, the Calibrator operates as a talker/listener.

IEEE 488 Bus Restrictions

The following restrictions apply to all IEEE 488 systems:

1. A maximum of 15 devices can be connected in a single IEEE 488 bus system.
2. The maximum length of IEEE 488 cable used in one IEEE 488 system is either: 2 meters times the number of devices in the system, or 20 meters, whichever is less.

Setting up the IEEE 488 Port

Setting up the Calibrator on the IEEE 488 bus requires setting the bus address and the connection to the controller. To set up for IEEE 488 bus control:

1. Turn off the Calibrator.
2. Connect the Calibrator to the controller using an IEEE 488 cable. Fluke shielded cables Y8021 (1m), Y8022 (2m), or Y8023 (4m), are recommended.
3. Turn the Calibrator's power on.
4. Press the **Setup** softkey.
5. Using the cursor keys or rotary knob, highlight **Interface** and either press the **Select** softkey or press in on the rotary knob.
6. If the Active Interface selection does not already read IEEE 488, use the cursor keys or rotary knob to highlight **Active Interface** and either press the **Select** softkey or push in on the rotary knob. Otherwise, skip to step 9.
7. Using the cursor keys or rotary knob, highlight **IEEE 488** and either press the **Select** softkey or push in on the rotary knob.
8. Press **Exit** to return to the Interface setup menu.
9. If the IEEE 488 Address selection does not already indicate the desired address, use the cursor keys or knob to highlight **IEEE 488 Address** and either press **Select** or press in on the rotary knob. Otherwise, skip to step 11.

Note

The IEEE address is set at the factory to 2, and remains at 2 until changed.

10. Press either the **UP** or **DOWN** softkey to change the address. The address can be set between 00 and 30.
11. Press the softkey under **Exit** in the display.

Using the RS-232 Port for Remote Control

Skip these instructions if you are using the IEEE 488 port to control the Calibrator remotely. The following procedure is for controlling the Calibrator from a terminal or a computer with a serial interface.

Setting up the RS-232 Port

To set the Calibrator for remote control through the RS-232 Port:

1. Turn the Calibrator off.
2. Connect the Calibrator to a terminal or computer using an RS-232 cable.
3. Turn the Calibrator's power on.
4. Press the **Setup** softkey.
5. Using the cursor keys or knob, highlight **Interface** and either press the **Select** softkey or push in on the rotary knob.
6. If the Active Interface selection does not already read RS232, use the cursor keys or rotary knob to highlight **Active Interface** and either press the **Select** softkey or push in on the rotary knob. Otherwise, skip to step 9.
7. Using the cursor keys or rotary knob, highlight **RS-232** and either press the **Select** softkey or push in on the rotary knob.
8. Press **EXIT** to return to the Interface setup menu.
9. If the baud rate is not already set to the desired speed, use the cursor keys or rotary knob to highlight **Baud Rate** and either press the **Select** softkey or push in on the rotary knob. Otherwise, skip to step 11
10. Press either the **UP** or **DOWN** softkey to set the baud rate to the desired speed. The baud rate must match the speed of the terminal or computer to which the Calibrator will be connected.

The baud rate can be set to 1200, 2400, 4800, 9600, 19200, 38400, 76800, or 115200.

11. Press the softkey under **Exit** in the display.

Data can now be transferred through the RS-232 Port in the format of 8 bits, no parity and one stop bit.

RS-232 Connector Pinout

Table 5-1 lists the signals on the 9-pin D Sub RS-232 connector on the back panel of the Calibrator.

Table 5-1. RS-232 Port Connector Pinout

Pin	Name	Direction	Description
2	TXD	Output	Transmit
3	FXD	Input	Receive
5	GRD	-	Ground

Note

It is not possible to send or receive data over RS-232 or Ethernet when the Calibrator is not in remote mode. You should use the command SYST:REM or SYST:RWL.

Exceptions for RS-232 Remote Control

When using the RS-232C port to remotely control the Calibrator, either interactively with a terminal or under computer control, operation is the same as using an IEEE 488 controller, with the following exceptions:

1. Control-C performs the same function as DCL (Device Clear) or SDC (Selected Device Clear).
2. The EOL (End of Line) input terminator is Carriage Return (Control/M) or Line Feed (Control-L).
3. Control-R echoes to the port a Carriage Return, a Line Feed, and any uncompleted remote command entered. This allows you to see a copy of whatever has been typed in since the last command.
4. There is no SRQ capability when using RS-232 port for remote control. The status registers still behave as described in this section, but the Calibrator's serial interface does not have a way to perform the SRQ function.
5. There are three special commands available only for serial remote control (and Ethernet): SYST:REM, SYST:RWL, and SYST:LOC. These are described in the SCPI Command Details section.

Using the Ethernet Connection for Remote Control

The following procedure is for controlling the Calibrator from a computer through an Ethernet connection or LAN. Setting up for Ethernet operation requires connecting the Calibrator to the computer with a LAN cable and enabling the Ethernet remote mode. The IP address, subnet mask, and gateway settings are set at the factory and cannot be changed.

To setup the Calibrator for remote operation using an Ethernet (LAN) connection:

1. Turn the Calibrator off.
2. Connect the Calibrator to the computer using a LAN cable.
3. Turn the Calibrator's power on.
4. Press the **Setup** softkey.

5. Using the cursor keys or knob, highlight **Interface** and either press the **Select** softkey or push in on the rotary knob.
6. If the Active Interface selection does not already read Ethernet, use the cursor keys or rotary knob to highlight **Active Interface** and either press the **Select** softkey or push in on the rotary knob. Otherwise, skip to step 9.
7. Using the cursor keys or rotary knob, highlight **Ethernet** and either press the **Select** softkey or push in on the rotary knob.
8. Press **Exit** to return to the Interface setup menu.

The Calibrator's IP address is set from the factory. You can view the IP address as follows:

1. Press the **Setup** softkey.
2. Using the cursor keys or knob, highlight **Interface** and either press the **Select** softkey or push in on the rotary knob.

The IP Address, local net mask, and local gateway are displayed.

3. Press **Exit** to return to the Interface setup menu.

Factory Settings

Table 5-2 lists the setup functions for the remote interface and their respective factory set values.

Table 5-2. Remote Interface Factory Settings

Setup Item	Factory Set Value
Active Interface	RS232
Baud rate	9600
IEEE488 address	02
IP address	192.168.001.200
Local network mask	255.255.255.000
Local network gateway	000.000.000.000

Command Syntax Information

All the commands described in this chapter can be issued through any of the three communication connections. However, to be properly processed by the Calibrator, each command must have the proper syntax.

The following syntax rules apply to all the remote commands. (A command consists of a word by itself or a word followed by one or more parameters.) A description of how the calibrator processes incoming characters provides the basis for answering other possible questions about syntax. Information about syntax of response messages is also given.

Parameter Syntax Rules

Many of the remote commands require parameters, which must be used properly to avoid command errors. When a command error (CME) error occurs, bit 5 in the Event Status Enable (ESR) goes to 1. General rules for parameter usage are:

1. When a command has more than one parameter, the parameters must be separated by commas.
2. When more than one command is contained in one line to the Calibrator, each command must be separated by a semicolon. For example: SAF:LR 100.5;:OUTP ON.
3. Numeric parameters may have up to 255 significant figures, and their exponents may range from -32000 to +32000. The useful range for Calibrator programming is $\pm 2.2 \text{ E-308}$ to $\pm 1.8 \text{ E308}$.
4. Including too many parameters causes a command error.
5. Null parameters cause a command error (e.g., the adjacent commas in CLOCK 133700, , 071787.).
6. Expressions, for example $(4+2*13)$, are not allowed as parameters.

Terminators

To signify the end of a response sent to the controller, the Calibrator sends a “terminator”. For response message terminators, the Calibrator sends the ASCII character Line Feed with the EOI control line held high. The following characters are recognized by the calibrator as terminators when encountered in incoming data:

- ASCII LF and CR characters
- Any ASCII character sent with the EOI control line true

Numeric Output Format

When the Calibrator is queried and a value is returned, the Calibrator formats the numerical value in standard exponential format. For example, 40 mA is output as 4.000000e-002.

Supported SCPI Commands

This section explains the SCPI (*Standard Commands for Programmable Instruments*) commands available to program the Calibrator. This section includes the following information:

- A list of the supported SCPI commands
- A discussion of how to use the command set
- A detailed description of each command in the set

Note

The following conventions are used for SCPI command syntax. Square brackets ([]) indicate optional keywords or parameters. Braces ({ }) enclose parameters within a command string. Triangle brackets (< >) indicate that you must substitute a value for the enclosed parameter. Capital letters indicate the abbreviated form of a command and are required while lowercase letters are optional.

Description of Abbreviations

Table 5-3. Abbreviation Descriptions

Abbreviation	Description
<DNPD>	Decimal Numeric Program Data. This format is used to express decimal number with or without the exponent.
<CPD>	Character Program Data. Usually it represents a group of alternative character parameters. e.g. {ON OFF 0 1}.
?	A flag indicating a request for the value of the parameter specified by the command. No parameter other than the question mark can be used.
(?)	A flag indicating a request for the parameter specified by the command. This command permits a value to be set as well as used a request.
<cr>	Carriage return. ASCII code 13. This code executes the program line.
<lf>	Line feed. ASCII code 10. This code executes the program line.

SCPI Command Summary

Tables 5-4 through 5-7 summarize the SCPI commands implemented in the Calibrator.

Table 5-4. OUTPut Command Summary

Command	Description
OUTPut[:STATe]?	Returns the state of the output terminals.
OUTPut[:STATe]{ON OFF}	Activates or deactivates output terminals .

Table 5-4. SOURce Command Summary

Command	Description
[SOURce]	Path to SOURCE subsystem.
:SAFety	Path to SAFETY modes.
:MODE?	Returns mode the Calibrator is set to.
:GBResistance	Sets Calibrator to Ground Bond Resistance mode.
[:LEVel] <DNPD>	Sets the value for the Ground Bond Resistance mode.
[:LEVel]?	Returns the set value for the Ground Bond Resistance mode.
:POSition <DNPD>	Sets the Ground Bond Resistance value to one of the 16 resistors.
:POSition?	Returns the selected resistor for the Ground Bond Resistance mode (0 = 25 mΩ to 15 = 2 kΩ).
:CURRent?	Returns the current flowing through the selected resistor.
[:CURR]:MAXimum?	Returns the measured peak current flowing through the selected resistance.
[:CURR]:CLEar?	Clears the measured peak current flowing through the selected resistance.
[:CURR]:LIMit?	Returns the maximum current allowed to flow through the resistance.
:GBOPen	Sets the Ground Bond Resistance function to the Open mode.

Table 5-4. SOURCE Command Summary (cont.)

Command	Description
:VOLTage?	Returns the measured voltage on the open output terminals.
[:VOLTage]	Path to the Ground Bond Resistance function's voltage parameters.
[:VOLTage]:MAXimum?	Returns the maximum measured peak voltage on the open output terminals.
[:VOLTage]:CLEar?	Clears the measured peak voltage on the open output terminals.
[:VOLTage]:LIMit?	Returns the maximum allowed voltage on the open output terminals.
:HRESistance	Sets Calibrator to High Resistance mode.
[:LEVel] <DNPD>	Sets the High Resistance value.
[:LEVel]?	Returns the set value for the High Resistance mode.
:LOW {GROund FLOat}	Connects or disconnect the Low terminal to ground.
:LOW?	Returns status of the Low Terminal grounding.
:MULTiplier {ON OFF}	Turns high resistance multiplier ON or OFF .
:MULTiplier?	Returns ON when multiplier is selected and OFF when it is not.
:RINP <DNPD>	Sets the sense terminal input resistance
:RINP?	Returns the resistance set at the sense terminal
:VOLTage?	Returns the voltage applied to the selected resistance.
[:VOLT]:LIMit?	Returns the maximum voltage allowed on the resistance.
:HRFix	Sets Calibrator to High Resistance Fixed resistance (100 GΩ) function.
[:LEVel]?	Returns the set value for the Resistance.
:LOW {GROund FLOat}	Connects or disconnect the Low terminal to ground.
:LOW?	Returns status of the Low Terminal grounding.
[:VOLTage]	Path to High Resistance Voltage parameters.
[:VOLTage]?	Returns the measured peak voltage on the open output terminals.
[:VOLTage]:MAXimum?	Returns the maximum allowed voltage across the resistance.
[:VOLTage]:CLEar?	Clears the measured peak voltage on the output terminals.
[:VOLTage]:LIMit?	Returns the maximum voltage allowed across the resistance.

Table 5-4. SOURce Command Summary (cont.)

Command	Description
:HRShort	Sets Calibrator to High Resistance function in the Short mode.
:LOW {GROund FLOat}	Connects or disconnect the Low terminal to ground.
:LOW?	Returns status of the Low Terminal grounding.
:CURRent?	Returns the current flowing through the selected resistor.
[:CURRent]	Path to High Resistance Short mode current parameters.
[:CURR]:MAXimum?	Returns the maximum measured peak current flowing through the shorted terminals.
[:CURR]:CLEar?	Clears the maximum measured peak current flowing through the shorted terminals.
[:CURR]:LIMit?	Returns the maximum current allowed to flow through the resistance.
:LROPen	Sets Calibrator to Low Resistance function in the Open mode.
:LOW {GROund FLOat}	Connects or disconnect the Low terminal to ground.
[:LOW]?	Returns status of the Low Terminal grounding.
[:VOLTage]	Returns the measured voltage on the open output terminals.
[:VOLTage]:MAXimum?	Returns the maximum measured peak voltage on the open output terminals.
[:VOLTage]:CLEar?	Clears the measured peak voltage on the open output terminals.
[:VOLTage]:LIMit?	Returns the maximum voltage allowed across the resistance.
:LRShort	Sets Calibrator to Low Resistance in Short mode.
:LOW {GROund FLOat}	Returns status of the Low Terminal grounding.
:LOW?	Returns the current flowing through the selected resistor.
:IDActive	Sets Calibrator to Active Leakage Current Mode.
[:CURRent]:NOMinal <DNPD>	Sets the Active Leakage Current value.
[:CURRent]:NOMinal?	Returns the nominal Active Leakage Current Value.
:IDSubstitute	Sets Calibrator to Substitute Leakage Current Mode.
[:CURRent]:NOMinal <DNPD>	Sets the Substitute Leakage Current value.
[:CURRent]:NOMinal?	Returns the nominal Substitute Leakage Current Value.
[:CURRent]:ROUT	Set the Substitute Leakage Current R_{OUT} value.
[:CURRent]:ROUT?	Returns the Substitute Leakage Current R_{OUT} value.
:LRESistance	Sets Calibrator to Low Resistance mode.

Table 5-4. SOURCE Command Summary (cont.)

Command	Description
[:LEVel] <DNPD>	Sets the Low Resistance value.
[:LEVel]?	Returns the set value for the Low Resistance mode.
:LOW {GROund FLOat}	Connects or disconnect the Low terminal to ground.
:LOW?	Returns status of the Low Terminal grounding.
:SENSe {ON OFF}	Selects between 4-wire and 2-wire resistance mode.
:SENSe?	Returns ON when 4-wire is selected and OFF when 2-wire is selected.
:CURR?	Returns the current flowing through the selected resistance.
[:CURR]:LIMit?	Returns the maximum current allowed to flow through the resistance.
:IDPassive	Sets Calibrator to Passive Leakage Current Mode.
[:CURRent]:NOMinal <DNPD>	Sets the Passive Leakage Current value.
[:CURRent]:NOMinal?	Returns the nominal Passive Leakage Current Value.
[:CURRent]:INSTant?	Returns instantaneous current flowing through the Calibrator.
[:CURRent]:RESulting?	Returns resulting measured UUT current.
:IDDifferential	Sets Calibrator to Differential Leakage Current Mode.
[:CURRent]:NOMinal <DNPD>	Set the Differential Leakage Current value.
[:CURRent]:NOMinal?	Returns the nominal Differential Leakage Current value.
[:CURRent]:INTstant?	Returns instantaneous current flowing through the Calibrator.
[:CURRent]:RESulting?	Returns resulting measured UUT current.
:RCDT	Path to RCD Trip Time mode.
:TIME <DNPD>	Set the trip time for the RCD Trip Time mode.
:TIME?	Returns the set trip time for the RCD Trip Time mode.
:CURRent?	Returns the measured trip current.
:RPOStion <DNPD>	Selects one of the 16 resistances available in the RCD Time function.
:RPOStion?	Returns the index value of the selected resistance.
[:CURRent]:NOMinal <DNPD>	Sets the nominal trip current value for the RCD Trip Time Mode.
[:CURRent]:NOMinal?	Returns the nominal trip current value.
[:CURRent]:MULTiplier <CPD>	Sets the trip current multiplier.
[:CURRent]:LEVel <CPD>	Sets the I level value.

Table 5-4. SOURce Command Summary (cont.)

Command	Description
[:CURRent]:LEVel?	Returns the I level value.
[:VOLTage]:LINE?	Returns the power supply voltage.
[:VOLTage]:TOUCH?	Returns the measured touch voltage.
:POLarity?	Returns type of test signal generated by UUT.
:RCDC	Path to RCD Trip Current mode.
:CURRent?	Returns the measured trip current.
:RPOSITION?	Returns the index value of the selected resistance.
[:CURRent]:NOMinal <DNPD>	Sets the nominal current value for RCD Trip Current mode.
[:CURRent]:NOMinal?	Returns the nominal trip current value.
[:VOLTage]:LINE?	Returns the power supply voltage.
[:VOLTage]:TOUCH?	Returns the measured touch voltage.
:POLarity?	Returns type of test signal generated by UUT.
:LINEimpedance	Path to Line Impedance mode.
[:LEVel] <DNPD>	Sets the resistance value for the Line Impedance mode.
[:LEVel]?	Returns the resistance value set for the Line Impedance mode.
:CORRection {OFF MAN SCAN COMP}	Sets the mode of residual impedance correction.
:CORRection?	Returns the residual impedance correction mode.
:POLarity?	Returns type of test signal generated by the UUT.
:CURRent?	Returns measured current flowing through resistance.
:CLEar	Clears the maximum value of peak current.
[:CURRent]:PFC?	Returns Prospective Fault Current value.
:MANual <DNPD>	Sets the Manual residual line impedance value.
:MANual?	Returns the set Manual residual line impedance value.
:SCAN?	Returns Scanned line residual impedance value.
:LOOPimpedance	Path to Loop impedance mode.
[:LEVel] [<DNPD>]	Sets resistance value for the Loop impedance mode.
[:LEVel]?	Returns the set resistance value for Loop impedance mode.
:CORRection {OFF MAN SCAN COMP}	Sets mode of residual impedance correction.
:CORRection?	Returns the set mode of the residual impedance correction.
:POLarity?	Returns type of test signal generated by the UUT.

Table 5-4. SOURCE Command Summary (cont.)

Command	Description
:CURRent?	Returns measured current flowing through selected resistance.
:CLEar	Clears the maximum value of peak current.
[:CURRent]:PFC?	Returns Prospective Fault Current value.
:MANual <DNPD>	Sets the Manual residual impedance value.
:MANual?	Returns the set Manual residual impedance value.
:SCAN?	Returns the Scanned loop impedance value.
:VOLTage	Path to Voltage Calibration mode.
[:LEVel] [<DNPD>]	Sets the voltage value for the voltage calibration mode.
[:LEVel]?	Returns the set voltage value for voltage calibration mode.
:CURRent?	Returns the measured load current value.
:FREQuency <DNPD>	Set the Frequency for the AC voltage calibration mode.
:FREQuency?	Returns the set Frequency for the AC voltage calibration mode.
:FUNction {DC AC}	Sets the Function of the output voltage.
:FUNction?	Returns the Function of the output voltage.
:LOW {GROund FLOat}	Connects or disconnects Calibrator LO terminal to/from ground.
:LOW?	Returns the status of the LO Terminal connection to ground.
:METer	Path to Meter function.
:FUNction {DC AC}	Sets the Multimeter Function.
:FUNction?	Returns the Multimeter Function setting.
:PROBe {OFF 10KV 40KV}	Sets HV probe for voltmeter.
:PROBe?	Returns the HV probe setting for voltmeter.
:LOW <CPD>	Connects or disconnects Multimeter LO terminal to or from ground.
:LOW?	Returns the status of the Multimeters LO terminal connection to ground.
:CURRent?	Returns the measured current by the ammeter.
:POWER?	Returns the measured power value.
:VOLTage?	Returns the measured voltage value.
:HIPL	Path to HIPOT leakage current function.
:FUNction {DC AC}	Sets the HIPOT leakage current mode: ac or dc.

Table 5-4. SOURce Command Summary (cont.)

:FUNction?	Returns the Multimeter Function setting.
:PROBe {OFF 10KV 40KV}	Sets HV probe for HIPOT leakage current.
:PROBe?	Returns the HV probe for HIPOT leakage current.
:CURRent?	Returns the measured current by the ammeter.
:VOLTage?	Returns the measured voltage value.
:HIPT	Path to HIPOT timer function.
:FUNction {DC AC}	Sets the HIPOT timer mode: ac or dc.
:FUNction?	Returns the Multimeter Function setting.
:TIME?	Returns the time interval.
:VOLTage?	Returns the measured voltage value.
[:VOLTage]:MAXimum?	Returns the maximum measured peak voltage.
:CLEar?	Clears the measured time and peak voltage.

Table 5-5. SYSTem Command Summary

Command	Description
SYSTem	Path to System commands.
:DATE <DNPD>, <DNPD>, <DNPD>	Sets the system date of the Calibrator.
:DATE?	Returns the Date set in the Calibrator.
:TIME <DNPD>, <DNPD>, <DNPD>	Sets the system Time in the Calibrator.
:TIME?	Returns the Time set in the Calibrator.
:ERRor?	Returns the first error in the error queue.
:REMote	Places the Calibrator in the Remote mode.
:RWLock	Places the Calibrator in the Remote mode with lockout.
:LOCal	Sets the Calibration to the Local mode.

Table 5-6. STATus Command Summary

Command	Description
STATus	Path to the Status commands.
:OPERational	Path to the Operational Data registers.
:EVENT?	Returns value in Operational Data Event register.
:ENABle <DPND>	Sets the bits of the Operational Data Enable register.
:ENABle?	Returns the vaule in the Operational Data Enable register.
:CONDition?	Returns the value in the Operational Condition register.
:QUESTionable	Path to the Questionable Data Event register.
:EVENT?	Returns value in Questionable Data Event register.
:ENABle <DPND>	Sets the bits of the Questionable Data Enable register.
:ENABle?	Returns the vaule in the Questionable Data Enable register.
:CONDition?	Returns the value in the Questionable Condition register.
:PRESet	Clears all bits in Operation Data Enable and Questionable Data Enable register.

Table 5-7. Common Command Summary

Command	Description
*IDN?	Returns manufacturer, model number, serial number and firmware revision number.
*OPC	Sets the OPC bit in the Event Status Register.
*OPC?	Returns "1" when all pending operations are complete.
*WAI	Prevents the Calibrator from executing command or queries until all previous remote commands have been executed.
*RST	Resets the Calibrator to its initial status.
*TST?	Starts a Calibrator self test and returns "0" for pass and "1" for fail.
*STB?	Returns value in the Status Byte Register.
*SRE <value>	Sets the Service Request Enable register.
*SRE?	Returns value in the Service Request Enable register.
*ESR?	Returns value in Event Status register.
*ESE <value>	Sets the Event Status register.
*ESE?	Returns value in the Event Status Enable register.
*CLS	Clears the Event Status register.

SCPI Command Details

The following sections give a detailed description of each command.

Using the OUTPUT Commands

Remotely controlling the application of the output signal to the Calibrator’s output terminals is accomplished through the OUTPUT command.

OUTPUT[:STATe](?) <CPD> {ON | OFF}

Description: Similar to the front panel’s OPERate key, this command will apply or remove the output signal to or from the Calibrator’s output terminals.

Parameters: <CPD> = ON Output signal applied
 OFF Output signal disconnected

Query: OUTP? Returns “ON” or “OFF” to indicate application of output signal.

Using the SOURCE Commands

Setting up functions that generate an output are controlled through the SOURCE command set. All calibration functions are controlled through a subset of commands under the SOURCE command called SAFETY.

[SOURCE]:SAFety

This subsystem allows controlling the individual functions of the calibrator.

[SOURCE]:SAF:MODE?

Description: This command returns the selected mode of the calibrator.

Query: SAF:MODE? Returns one of the following functions:
 GBR – Ground Bond Resistance
 GBOP – Ground Bond Resistance Open
 GBTR – Ground Bond Resistance Transfer
 HRES – High Resistance
 HRF – 100 GΩ Fixed Resistance
 HROP – High Resistance Open
 HRSH – High Resistance Short
 LRES – Low Resistance
 LROP – Low Resistance Open
 LRSH – Low Resistance Short
 IDAC – Active Leakage Current
 IDS – Substitute Leakage Current
 IDP – Passive Leakage Current
 IDD – Differential Leakage Current
 RCDT – RCD Trip Time
 RCDC – RCD Trip Current
 LINE – Line Impedance
 LOOP – Loop Impedance
 VOLT – Voltage Calibration
 MET – Multimeter
 HIPL – HIPOT Leakage Current
 HIPT – HIPOT Timer

[SOUR]:SAF:GBR[:LEV] (?) [<DNPD>]

Description: This command selects one of 16 discrete resistors closest to the value specified by DNPd. If not already selected, it also switches the Calibrator to the Ground Bound Resistance function.

Parameters: <DNPd> Resistance value in ohms.

Example: SAF:GBR 0.1 Ground Bond Resistance with 100 m Ω .

Query: SAF:GBR? Returns the selected resistance value in ohms.

[SOUR]:SAF:GBR:RPOS (?) <DNPd>

Description: This command selects one of the 16 resistances available in the GBR function. The index of resistance is from 0 (25 m Ω) to 15 (2 k Ω). If not already selected, it also switches the Calibrator to the Ground Bound Resistance function.

Parameters: <DNPd> Index number of the desired resistance. The range is 0 (25 m Ω) to 15 (2 k Ω).

Example: SAF:GBR:RPOS 2 Ground Bond Resistance with 100 m Ω (position 2).

Query: SAF:GBR:RPOS? Returns the index value of the selected resistance.

[SOUR]:SAF:GBR:CURR?

Description: This command returns the measured current flowing through the selected resistance. If not already selected, it also switches the Calibrator to the Ground Bound Resistance function.

Query: SAF:GBR:POS?

[SOUR]:SAF:GBR[:CURR]:LIM?

Description: This command returns the maximum allowed current through the selected resistance. If not already selected, it also switches the Calibrator to the Ground Bound Resistance function.

Query: SAF:GBR:LIM?

[SOUR]:SAF:GBR[:CURR]:MAX?

Description: This command returns the measured peak current flowing through the selected resistance. If not already selected, it also switches the Calibrator to the Ground Bound Resistance function.

This value can be cleared using the SAF:GBR:CLEar command.

Query: SAF:GBR:MAX?

[SOUR]:SAF:GBR[:CURR]:CLE

Description: This command clears the measured peak current flowing through the selected resistance. If not already selected, it also switches the Calibrator to the Ground Bound Resistance function.

Example: SAF:GBR:CLE

[SOUR]:SAF:GBOP

Description: This command switches the Calibrator to the Ground Bound Resistance function and sets the Open mode. If not already selected, it also switches the Calibrator to the Ground Bound Resistance function.

Example: SAF:GBOP

[SOUR]:SAF:GBOP:VOLT?

Description: This command returns the measured voltage on the open output terminals. If not already selected, it also switches the Calibrator to the Ground Bound Resistance function in the Open mode.

Query: SAF:GBOP:VOLT?

[SOUR]:SAF:GBOP[:VOLT]:LIM?

Description: This command returns the maximum allowed voltage on the open output terminals. If not already selected, it also switches the Calibrator to the Ground Bound Resistance function in the Open mode.

Query: SAF:GBOP:LIM?

[SOUR]:SAF:GBOP[:VOLT]:MAX?

Description: This command returns the maximum measured peak voltage on the open output terminals. If not already selected, it also switches the Calibrator to the Ground Bound Resistance function in the Open mode.

This value can be cleared using the SAF:GBOP:CLEAR command.

Query: SAF:GBOP:MAX?

[SOUR]:SAF:GBOP[:VOLT]:CLE

Description: This command clears the measured peak voltage on the open output terminals. If not already selected, it also switches the Calibrator to the Ground Bound Resistance function.

Example: SAF:GBOP:CLE

[SOUR]:SAF:GBTR[:LEV](?) [<DNPD>]

Description: This command sets the nominal resistance value.

Parameters: <DNPD> The value of resistance expressed in ohms. Table 4-2 in Chapter 4 lists the acceptable range of resistance values.

Example: SAF:GBTR 0.1 Dround Bond Resistance Transfer with 100 mΩ.

Query: SAF:GBTR? Returns the value of resistance using standard exponential format.

[SOUR]:SAF:GBTR:RPOS(?) [<DNPD>]

Description: This command selects on of six available resistances. Index of resistance is from 0 (50 mΩ) to 5 (500 mΩ).

Parameters:	<DNPD>	The value of the index of required resistance (0 – 5).
Example:	SAF:GBTR:RPOS 1	Ground Bond Resistance Transfer index 1 or 100 mΩ.
Query:	SAF:GBTR:RPOS?	Returns the value of the index of the selected resistance using standard exponential format. For example an index of 4 is returned as 4.000000e+000.

[SOUR]:SAF:GBTR:FUNC(?) <CPD> {DC |AC}

Description:	This command sets the Calibrator to the Ground Bond Resistance Transfer mode and selects between ac or dc.	
Parameters:	<CPD>	DC = dc GBR Transfer mode AC = ac GBR Transfer mode.
Example:	SAF:GBTR:FUNC AC	Sets the ac GBR Transfer mode.
Query:	SAF:GBTR:FUNC?	Returns ac or dc depending on which GBR mode is set in the Calibrator.

[SOUR]:SAF:GBTR:RRES?

Description:	This command returns the measured resistance value of the Ground Bond Resistance Transfer.	
Query:	SAF:GBTR:RRES?	Returns the value of resistance in standard exponential format. For example, 54.2 mΩ is returned as 5.420000e-002.

[SOUR]:SAF:GBTR:CURR?

Description:	This command returns the measure value of the current flowing through the selected resistance.	
Query:	SAF:GBTR:CURR?	Returns the value of the resistor current value in standard exponential format. For example, 2.5 A is returned as 2.500000e+000.

[SOUR]:SAF:GBTR[:CURR]:MAX?

Description:	This command returns the maximum (peak) current that flows through the selected resistance. The maximum value can be cleared using the SAF:GBTR:CLEAR command.	
Query:	SAF:GBTR:MAX?	Returns the value of current flowing through the selected resistance.

[SOUR]:SAF:GBTR[:CURR]:CLE

Description:	This command clears the maximum (peak) current that flows through the selected resistance.	
Example:	SAF:GBTR:CLE	

[SOUR]:SAF:GBTR[:CURR]:LIM?

Description: This command returns the maximum allowed to flow through the selected resistance.

Query: SAF:GBTR:LIM? 1.000000e+001 = 10 amps

[SOUR]:SAF:HRES[:LEV](?) [<DNPD>]

Description: This command sets the resistance value for the High Resistance Source function. If not already selected, it also switches the Calibrator to the High Resistance Source function.

Parameters: <DNPD> The value of resistance expressed in ohms. Table 4-2 in Chapter 4 lists the acceptable range of resistance values.

Example: SAF:HRES 1.052E6 High Resistance Source function with 1.052 MΩ.

Query: SAF:HRES? Returns the value of the selected resistance.

[SOUR]:SAF:HRES:LOW(?) <CPD> {FLO | GRO}

Description: This command connects or disconnects the High Resistance **LO** terminal to or from ground. If not already selected, it also switches the Calibrator to the High Resistance Source function.

Parameters: <CPD> FL = floating output
GRO = grounded output

Example: SAF:HRES:LOW GRO Grounds the output LO terminal.

Query: SAF:HRES:LOW? Returns the grounded state of the Output LO terminal, GRO or FLO.

[SOUR]:SAF:HRES:MULT(?) <CPD> {ON | OFF}

Description: This command enables the probe (high resistance multiplier). If enabled, the selected resistance value is multiplied by 1000. If not already selected, it also switches the Calibrator to the High Resistance Source function.

Parameters: <CPD> ON = enables the high resistance multiplier.
OFF = disables the high resistance multiplier.

Example: SAF:HRES:MULT ON Enable high resistance multiplier.

Query: SAF:HRES:MULT? Returns the state of the high resistance multiplier. ON = enabled, OFF = disabled.

[SOUR]:SAF:HRES:RINP(?) <DNPD>

Description: This command sets the input resistance of the Sense terminal. If not already selected, it also switches the Calibrator to the High Resistance Source function.

Parameters: <DNPD> The value of resistance expressed in ohms. Default value is 0 and range is limited to 100 MΩ.

Example: SAF:HRES:RINP 10.52E6 Sets serial resistance to 10.52 MΩ.

Query: SAF:HRES:RINP? Returns the value of the serial resistance.

[SOUR]:SAF:HRES:VOLT?

Description: This command returns the measured voltage on the resistance. If not already selected, it also switches the Calibrator to the High Resistance Source function.

Query: SAF:HRES:VOLT?

[SOUR]:SAF:HRES[:VOLT]:LIM?

Description: This command returns maximum allowed value of voltage on the resistance. If not already selected, it also switches the Calibrator to the High Resistance Source function.

Query: SAF:HRES:LIM?

[SOUR]:SAF:HRES[:VOLT]:MAX?

Description: This command returns the maximum measured peak voltage on the resistance. If not already selected, it also switches the Calibrator to the High Resistance Source function.

This value can be cleared using the SAF:HRES:CLEar command.

Query: SAF:HRES:MAX?

[SOUR]:SAF:HRES[:VOLT]:CLE

Description: This command clears the measured peak voltage on the resistance. If not already selected, it also switches the Calibrator to the High Resistance Source function.

Example: SAF:HRES:CLE

[SOUR]:SAF:HRF(?)

Description: This command selects the high resistance source function with the 100 G Ω fixed resistance.

Example: SAF:HRF Selects 100 G Ω fixed resistance.

Query: SAF:HRF? Returns the value of the fixed resistance.

[SOUR]:SAF:HRF:LOW(?) {FLO | GRO}

Description: This command connects or disconnects the High Resistance **LO** terminal to or from **GND** terminal. If not already selected, it also switches the Calibrator to the High Resistance Fixed 100 G Ω resistance source function.

Parameters: <CPD> FL = floating output
GRO = grounded output

Example: SAF:HRF:LOW GRO Grounds the High Resistance LO terminal.

Query: SAF:HRF:LOW? Returns the grounded state of the High Resistance LO terminal, GRO or FLO.

[SOUR]:SAF:HRF:VOLT?

Description: This command returns the measured voltage across the selected fixed resistance. If not already selected, it also switches the Calibrator to the High Resistance Fixed 100 GΩ resistance source function.

Query: SAF:HRF:VOLT? Returns the measured voltage across the fixed resistance.

[SOUR]:SAF:HRF:LIM?

Description: This command returns the maximum allowed voltage across the selected fixed resistance. If not already selected, it also switches the Calibrator to the High Resistance Fixed 100 GΩ resistance source function.

Query: SAF:HRF:LIM? Returns the maximum allowed voltage across the fixed resistance.

[SOUR]:SAF:HRF[:VOLT]:MAX?

Description: This command returns the maximum measured peak voltage on the resistance. If not already selected, it also switches the Calibrator to the High Resistance Fixed 100 GΩ resistance source function.

This value can be cleared using the SAF:HRF:CLEar command.

Query: SAF:HRF:MAX?

[SOUR]:SAF:HRF[:VOLT]:CLE

Description: This command clears the measured peak voltage on the resistance. If not already selected, it also switches the Calibrator to the High Resistance Fixed 100 GΩ resistance source function.

Example: SAF:HRF:CLE

[SOUR]:SAF:HRSH

Description: This command sets the Calibrator to the High Resistance source function in the Short mode.

Example: SAF:HRSH

[SOUR]:SAF:HRSH:LOW(?) <CPD> {FLO | GRO}

Description: This command connects or disconnects the High Resistance **LO** terminal to/from ground. If not already selected, it also switches the Calibrator to the High Resistance Source function in the Short mode.

Parameters: <CPD> FL = floating output
GRO = grounded output

Example: SAF:HRSH:LOW GRO Grounds the output LO terminal.

Query: SAF:HRSH:LOW? Returns the grounded state of the Output LO terminal, GRO or FLO.

[SOUR]:SAF:HRSH:CURR?

Description: This command returns the measured value of current flowing through the shorted terminals. If not already selected, it also switches the Calibrator to the High Resistance Source function in the Short mode.

Query: SAF:HRSH:CURR? Returns the measured current value.

[SOUR]:SAF:HRSH[:CURR]:LIM?

Description: This command returns the maximum current allowed to flow through the shorted terminals. If not already selected, it also switches the Calibrator to the High Resistance Source function in the Short mode.

Query: SAF:HRSH:LIM? Returns the maximum current value.

[SOUR]:SAF:HRSH[:CURR]:MAX?

Description: This command returns the maximum measured peak current flowing through the shorted terminals. If not already selected, it also switches the Calibrator to the High Resistance Source function in the Short mode.

This value can be cleared using the SAF:HRSH:CLEAr command.

Query: SAF:HRSH:MAX? Returns the maximum current value.

[SOUR]:SAF:HRSH[:CURR]:CLE

Description: This command clears the measured peak current flowing through the shorted terminals. If not already selected, it also switches the Calibrator to the High Resistance Fixed 100 G Ω resistance source function in the Short mode.

Example: SAF:HRSH:CLE

[SOUR]:SAF:LRES[:LEV](?) [<DNPD>]

Description: This command switches the calibrator to Low Resistance Source function and sets the resistance value to the value contained in DNPD.

Parameters: <DNPD> The value of the resistance expressed in ohms. Table 4-1 in Chapter 4 lists the acceptable range of values.

Example: SAF:LRES 105.2 Low Resistance Source function with 105.2 Ω .

Query: SAF:LRES? Returns the value of the selected resistance.

[SOUR]:SAF:LRES:LOW(?) <CPD> {FLO | GRO}

Description: This command connects or disconnects the Low Resistance **LO** terminal to or from **GND** terminal. If not already selected, it also switches the Calibrator to the Low Resistance Source function.

Parameters: <CPD> FL = floating output
GRO = grounded output

Example: SAF:LRES:LOW GRO Grounds the Low Resistance LO terminal.

Query: SAF:LRES:LOW? Returns the grounded output state, GRO or FLO.

[SOUR]:SAF:LRES:SENS(?) <CPD> {ON | OFF}

Description: This command selects 4-wire Low Resistance mode (remote sense). If not already selected, it also switches the Calibrator to the Low Resistance Source function.

Parameters: <CPD> ON = 4-wire mode
 OFF = 2-wire mode

Example: SAF:LRES:SENS ON Low Resistance Source function with 105.2 Ω.

Query: SAF:LRES:SENS? Returns the state of the 4-wire mode, ON or OFF.

[SOUR]:SAF:LRES:CURR?

Description: This command returns the measured value of current flowing through the resistance. If not already selected, it also switches the Calibrator to the Low Resistance Source function.

Query: SAF:LRES:CURR? Returns the measured current value.

[SOUR]:SAF:LRES[:CURR]:LIM?

Description: This command returns the maximum current allowed to flow through the resistance. If not already selected, it also switches the Calibrator to the Low Resistance Source function.

Query: SAF:LRES:LIM? Returns the maximum current value.

[SOUR]:SAF:LRES[:CURR]:MAX?

Description: This command returns the maximum measured peak current flowing through the selected resistance. If not already selected, it also switches the Calibrator to the Low Resistance Source function.

This value can be cleared using the SAF:LR:CLEar command.

Query: SAF:LRES:MAX? Returns the maximum current value.

[SOUR]:SAF:LRES[:CURR]:CLE

Description: This command clears the measured peak current flowing through the selected resistance. If not already selected, it also switches the Calibrator to the Low Resistance Source function.

Example: SAF:LRES:CLE

[SOUR]:SAF:LROP

Description: This command switches the Calibrator to the Low Resistance Source function and sets the Open mode.

Example: SAF:LROP

[SOUR]:SAF:LROP:LOW(?) <CPD> {FLO | GRO}

Description: This command connects or disconnects the Low Resistance **LO** terminal to or from **GND** terminal. If not already selected, it also switches the Calibrator to the Low Resistance Source function in the Open mode.

Parameters: <CPD> FL = floating output
GRO = grounded output

Example: SAF:LROP:LOW GRO Grounds the Low Resistance LO terminal.

Query: SAF:LROP:LOW? Returns the grounded output state, GRO or FLO.

[SOUR]:SAF:LROP:VOLT?

Description: This command returns the measured voltage on the open output terminals. If not already selected, it also switches the Calibrator to the Low Resistance function in the Open mode.

Query: SAF:LROP:VOLT?

[SOUR]:SAF:LROP[:VOLT]:LIM?

Description: This command returns the maximum allowed voltage on the open output terminals. If not already selected, it also switches the Calibrator to the Low Resistance function in the Open mode.

Query: SAF:LROP:LIM?

[SOUR]:SAF:LROP[:VOLT]:MAX?

Description: This command returns the maximum measured peak voltage on the open output terminals. If not already selected, it also switches the Calibrator to the Low Resistance function in the Open mode.

This value can be cleared using the SAF:GBOP:CLEar command.

Query: SAF:LROP:MAX?

[SOUR]:SAF:LROP[VOLT]:CLE

Description: This command clears the measured peak voltage on the open output terminals. If not already selected, it also switches the Calibrator to the Low Resistance function in the Open mode.

Example: SAF:LROP:CLE

[SOUR]:SAF:LRSH

Description: This command switches the Calibrator to the Low Resistance Source function in the Short mode.

Example: SAF:LRSH

[SOUR]:SAF:LRSH:LOW(?) <CPD> {FLO | GRO}

Description: This command connects or disconnects the Low Resistance **LO** terminal to or from **GND** terminal. If not already selected, it also switches the Calibrator to the Low Resistance Source function in the Short mode.

Parameters: <CPD> FL = floating output
GRO = grounded output

Example: SAF:LRSH:LOW GRO Grounds the Low Resistance LO terminal.

Query: SAF:LRSH:LOW? Returns the grounded output state, GRO or FLO.

[SOUR]:SAF:IDAC

Description: This command switches the Calibrator to the Active Leakage Current function.

Example: SAF:IDAC Active Leakage Current function selected with parameters set previously.

[SOUR]:SAF:IDAC[:CURR]:NOM (?) <DNPD>

Description: This command sets the nominal current value to the value specified in DNPD. If not already selected, it also switches the Calibrator to the Active Leakage Current function.

Parameters: <DNPD> The value of nominal current expressed in amps. Refer to the Leakage Current specifications in Chapter 1 for the acceptable range of values for this function.

Example: SAF:IDAC:NOM 0.01 Active Leakage Current function with a nominal current of 10 mA.

Query: SAF:IDAC:NOM? Returns the nominal leakage current value.

Note: Nominal leakage current is valid for all leakage current modes (IDA, IDP, IDS and IDD).

[SOUR]:SAF:IDS

Description: This command switches the Calibrator to the Substitute Leakage Current function.

Example: SAF:IDS Substitute Current function selected with previously set parameters.

[SOUR]:SAF:IDS[:CURR]:NOM (?) <DNPD>

Description: This command sets the nominal leakage current to the value specified in DNPD. If not already selected, it also switches the Calibrator to the Substitute Leakage Current function.

Parameters: <DNPD> The value of leakage current expressed in amps. Refer to the Leakage Current specifications in Chapter 1 for the acceptable range of values for this function.

Example: SAF:IDS:NOM 0.01 Substitute Leakage Current function with 10 mA nominal current setting.

Query: SAF:IDS:NOM? Returns the value of the nominal current setting.

Note: Nominal leakage current is valid for all leakage current modes (IDA, IDP, IDS and IDD).

[SOUR]:SAF:IDS:ROUT(?) <DNPD>

- Description:** This command sets the output UUT resistance to the value specified in DNPD. If not already selected, it also switches the Calibrator to the Substitute Leakage Current function.
- Parameters:** <DNPD> The value of UUT output resistance expressed in ohms.
- Example:** SAF:IDS:ROUT 2000 Sets the output resistance of the UUT to 2000 Ω .
- Query:** SAF:IDS:ROUT? Returns the value of the UUT output resistance setting.

[SOUR]:SAF:IDP

- Description:** This command switches the Calibrator to the Passive Leakage Current function.
- Example:** SAF:IDP Passive Current function selected with parameters set previously.

[SOUR]:SAF:IDP[:CURR]:NOM (?) <DNPD>

- Description:** This command sets the nominal leakage current to the value specified in DNPD. If not already selected, it also switches the Calibrator to the Passive Leakage Current function.
- Parameters:** <DNPD> The value of leakage current expressed in amps. Refer to the Leakage Current specifications in Chapter 1 for the acceptable range of values for this function.
- Example:** SAF:IDP:NOM 0.01 Passive Leakage Current function with 10 mA nominal current setting.
- Query:** SAF:IDP:NOM? Returns the value of the nominal current setting.
- Note:** Nominal leakage current is valid for all leakage current modes (IDA, IDP, IDS and IDD).

[SOUR]:SAF:IDP[:CURR]:INST?

- Description:** This command returns the instantaneous measured current flowing through the calibrator. If not already selected, it also switches the Calibrator to the Passive Leakage Current function.
- Query:** SAF:IDP:INST? Returns the value of the instantaneous current flowing through the Calibrator.

[SOUR]:SAF:IDP[:CURR]:RES?

- Description:** This command returns the measured current flowing through the UUT. If not already selected, it also switches the Calibrator to the Passive Leakage Current function.
- Query:** SAF:IDP:RES? Returns the value of the resulting measured UUT current.

[SOUR]:SAF:IDD

Description: This command switches the Calibrator to the Differential Leakage Current function.

Example: SAF:IDD Differential Current function selected with parameters set previously.

[SOUR]:SAF:IDD[:CURR]:NOM (?) <DNPD>

Description: This command sets the nominal leakage current to the value specified in DNPD. If not already selected, it also switches the Calibrator to the Differential Leakage Current function.

Parameters: <DNPD> The value of leakage current expressed in amps. Refer to the Leakage Current specifications in Chapter 1 for the acceptable range of values for this function.

Example: SAF:IDD:NOM 0.01 Differential Leakage Current function with 10 mA nominal current setting.

Query: SAF:IDD:NOM? Returns the value of the nominal current setting.

Note: Nominal leakage current is valid for all leakage current modes (IDA, IDP, IDS and IDD).

[SOUR]:SAF:IDD[:CURR]:INST?

Description: This command returns the instantaneous measured current flowing through the calibrator. If not already selected, it also switches the Calibrator to the Differential Leakage Current function.

Query: SAF:IDD:INST? Returns the value of the instantaneous current flowing through the Calibrator.

[SOUR]:SAF:IDD[:CURR]:RES?

Description: This command returns the measured current flowing through the UUT. If not already selected, it also switches the Calibrator to the Differential Leakage Current function.

Query: SAF:IDD:RES? Returns the value of the resulting measured UUT current.

[SOUR]:SAF:RCDT:TIME (?) <DNPD>

Description: This command sets the nominal value of trip time for the RCD Trip Time function. If not already selected, it also switched the Calibrator to the RCD Time function.

Parameters: <DNPD> The value of trip time expressed in seconds. Refer to the RCD specifications in Chapter 1 for the acceptable range of values for this function.

Example: SAF:RCDT:TIME 0.055 RCD Trip Time function with a trip time of 55 ms.

Query: SAF:RCDT:TIME? Returns the value of the trip time setting.

[SOUR]:SAF:RCDT:CURRE?

Description: This command returns the measured trip current. If not already selected, it also switches the Calibrator to the RCD Time function.

Query: SAF:RCDT:CURRE? Returns the measured trip current.

[SOUR]:SAF:RCDT:RPOS(?) <DNPD>

Description: This command selects one of the 16 resistances available in the RCD Time function. The index of resistance is from 0 (25 m Ω) to 15 (2 k Ω). If not already selected, it also switches the Calibrator to the RCD Time function.

Parameters: <DNPD> Index number of the desired resistance. The range is 0 (25 m Ω) to 15 (2 k Ω).

Example: SAF:RCDT:RPOS 2 RCD Time function with 100 m Ω (position 2).

Query: SAF:RCDT:RPOS? Returns the index value of the selected resistance.

Note: The selected resistance is valid for RCD Current function as well.

[SOUR]:SAF:RCDT[:CURRE]:NOM(?) <DNPD>

Description: This command sets the nominal trip current value to the value specified by DNPD. If not already selected, it also switches the Calibrator to the RCD Time function.

Parameters: <DNPD> The value of trip current expressed in amps. Refer to the RCD specifications in Chapter 1 for the acceptable range of values for this function.

Example: SAF:RCDT:NOM 1 RCD Trip Time function with a nominal trip current of 1 amp.

Query: SAF:RCDT:NOM? Returns the value of the nominal trip current setting.

Note: The selected nominal current value is valid for the RCD Current function as well.

[SOUR]:SAF:RCDT[:CURRE]:MULT (?) <CPD> {0.5X | 1X | 1.4X | 2X | 5x}

Description: This command sets the multiplier of nominal trip current to the value specified by CPD. If not already selected, it also switches the Calibrator to the RCD Time function.

Parameters: <CPD> 0.5X = 0.5 times nominal trip current
1X = 1 times nominal trip current
1.4X = 1.4 times nominal trip current
2X = two times nominal trip current
5X = five times nominal trip current

Example: SAF:RCDT:MULT 2X RCD Trip Time function with a times 2 multiplier of nominal trip current.

Query: SAF:RCDT:MULT? Returns the multiplier value for the nominal trip current setting.

[SOUR]:SAF:RCDT[:CURR]:LEV (?) <CPD> {5 % | 30 % | 60 % | 75 % | 90 % | 100 % | 120 %}

- Description:** This command sets the percent of nominal trip current level to the value specified by CPD. If not already selected, it also switches the Calibrator to the RCD Time function.
- Parameters:** <CPD> The percentage of trip current.
- Example:** SAF:RCDT:LEV 60 % RCD Trip Time function with a current level of 60 %.
- Query:** SAF:RCDT:LEV? Returns the current level setting for the RCD trip time function.

[SOUR]:SAF:RCDT:[VOLT]:LIN?

- Description:** This command returns the power supply voltage. If not already selected, it also switches the Calibrator to the RCD Time function.
- Query:** SAF:RCDT:LINE? Returns the measured value of the voltage power supply.





[SOUR]:SAF:RCDT:[VOLT]:TOUC?

- Description:** This command returns the measured touch voltage. If not already selected, it also switches the Calibrator to the RCD Time function.
- Query:** SAF:RCDT:TOUC? Returns the measured value of the touch voltage.

[SOUR]:SAF:RCDT:POL?

- Description:** This command returns the type of test signal generated by the UUT {POS | NEG | SYMP | SYMN | DCP | DCN | NO}. If not already selected, it also switches the Calibrator to the RCD Time function.
- Query:** SAF:RCDT:POL? Returns the type of UUT test signal.

Types are:

-  Test current is pulse (dc) with positive polarity (POS)
 -  Test current is pulse (dc) with negative polarity (NEG)
 -  Test current is symmetrical (ac) with positive phase (SYMP)
 -  Test current is symmetrical (ac) with negative phase (SYMN)
 - POS Test current is dc with positive polarity (DCP)
 - NEG Test current is dc with negative polarity (DCN)
- NO is returned when the generated test signal is not valid.

[SOUR]:SAF:RCDC

- Description:** This command switches the Calibrator to RCD Trip Current function.
- Example:** SAF:RCDC Set RCD Trip Current function.

[SOUR]:SAF:RCDC:CURRE?

Description: This returns the trip current. If not already selected, it also switches the Calibrator to the RCD Current function.

Query: SAF:RCDC:CURRE? Returns the current trip level.

[SOUR]:SAF:RCDC:RPOS(?) <DNPD>

Description: This command selects one of the 16 resistances available in the RCD Current function. The index of resistance is from 0 (25 m Ω) to 15 (2 k Ω). If not already selected, it also switches the Calibrator to the RCD Current function.

Parameters: <DNPD> Index number of the desired resistance. The range is 0 (25 m Ω) to 15 (2 k Ω).

Example: SAF:RCDC:RPOS 2 RCD Current function with 100 m Ω (position 2).

Query: SAF:RCDC:RPOS? Returns the index value of the selected resistance.

Note: The selected resistance is valid for the RCD Time function as well.

[SOUR:SAF:RCDC[:CURRE]:NOM(?) <DNPD>

Description: This command sets the nominal trip current value to the value specified by DNPD. If not already selected, it also switches the Calibrator to the RCD Current function.

Parameters: <DNPD> The value of trip current expressed in amps.

Example: SAF:RCDC:NOM 1 RCD Trip Current function with a nominal trip current of 1 amp.

Query: SAF:RCDC:NOM? Returns the value of the nominal trip current setting.

Note: The selected nominal current value is valid for the RCD Time function as well.

[SOUR:SAF:RCDC[:CURRE]:MAX?

Description: This command returns the maximum (peak) value of trip current. Use the SAF:RCDC:CLEAr command to clear the maximum value. Calibrator returns the current value using standard exponential format. For example, 20 mA is returned as 2.000000e-002.

Example: SAF:RCDC:MAX?

Note: Command switches the calibrator in RCD Trip Current function mode.

[SOUR:SAF:RCDC[:CURRE]:CLE

Description: This command clears the maximum (peak) value of trip current

Example: SAF:RCDC:CLE

Note: Command switches the calibrator in RCD Trip Current function mode.

[SOUR]:SAF:RCDC:[VOLT]:LIN?

Description: This command returns the power supply voltage. If not already selected, it also switches the Calibrator to the RCD Current function.

Query: SAF:RCDDT:LIN? Returns the measured value of the voltage power supply.

[SOUR]:SAF:RCDC:[VOLT]:TOUC?

Description: This command returns the measured touch voltage. If not already selected, it also switches the Calibrator to the RCD Current function.

Query: SAF:RCDDT:TOUC? Returns the measured value of the touch voltage.

[SOUR]:SAF:RCDC:POL?

Description: This command returns the type of test signal generated by the UUT {POS | NEG | SYMP | SYMN | DCP | DCN | NO}. If not already selected, it also switches the Calibrator to the RCD Current function.

Query: SAF:RCDC:POL? Returns the type of UUT test signal.

Types are:

- \wedge Test current is pulse (dc) with positive polarity (POS)
- \vee Test current is pulse (dc) with negative polarity (NEG)
- $\wedge \vee$ Test current is symmetrical (ac) with positive phase (SYMP)
- $\vee \wedge$ Test current is symmetrical (ac) with negative phase (SYMN)
- POS Test current is dc with positive polarity (DCP)
- NEG Test current is dc with negative polarity (DCN)

NO is returned when the generated test signal is not valid.

[SOUR]:SAF:LIN [:LEV](?) [<DNPD>]

Description: This command sets the resistance value to the value specified in DNPd. If not already selected, it also switches the Calibrator to the Line Impedance function.

Parameters: <DNPd> The value of resistance expressed in ohms. The calibrator will select the closest resistance value.

Example: SAF:LIN 0.1 Line impedance function with a resistance of 100 mΩ.

Query: SAF:LIN? Returns the value of the resistance setting.

[SOUR]:SAF:LIN:CORR (?) <CPD> {OFF | MAN | SCAN | COMP}

Description: This command sets the type of residual impedance correction for Line Impedance specified by CPD. If not already selected, it also switches the Calibrator to the Line Impedance function.

Parameters: <CPD> Type of residual impedance correction.
 No = no correction.
 MAN = manual correction.
 SCAN = scanned correction.
 COMP = compensated correction

Example: SAF:LIN:CORR MAN Sets manual residual impedance correction mode.

Query: SAF:LIN:CORR? Returns the type of residual correction mode selected.

[SOUR]:SAF:LIN:POL?

Description: Returns the type of test signal generated by the UUT. If not already selected, it also switches the Calibrator to the Line Impedance function.

Query: SAF:LIN:POL?

Types are:

- \sim Test current is pulse (dc) with positive polarity (POS)
- \surd Test current is pulse (dc) with negative polarity (NEG)
- \frown Test current is symmetrical (ac) with positive phase (SYMP)
- \smile Test current is symmetrical (ac) with negative phase (SYMN)
- POS Test current is dc with positive polarity (DCP)
- NEG Test current is dc with negative polarity (DCN)

NO is returned when the generated test signal is not valid.

[SOUR]:SAF:LIN:CURR?

Description: Returns the measured maximum value of peak current flowing through the selected resistance. If not already selected, it also switches the Calibrator to the Line Impedance function.

Query: SAF:LIN:CURR?

Note: The maximum value can be cleared with the SAF:LINE:CLE command.

[SOUR]:SAF:LIN:CLE

Description: This command clears the maximum value of peak current. If not already selected, it also switches the Calibrator to the Line Impedance function.

Example: SAF:LIN:CLE

[SOUR]:SAF:LIN[:CURR]:PFC?

Description: Returns the value of prospective fault current. If not already selected, it also switches the Calibrator to the Line Impedance function.

Query: SAF:LIN:PFC?

[SOUR]:SAF:LIN:MAN(?) <DNPD>

Description: This command sets the manual value of line residual impedance. If not already selected, it also switches the Calibrator to the Line Impedance function.

Parameters: <DNPD> The value of residual impedance in ohms.

Example: SAF:LIN:MAN 0.87 Set manual compensation value to 0.87 Ω .

Query: SAF:LIN:MAN? Returns the manual compensation value.

[SOUR]:SAF:LIN:SCAN?

Description: Returns the scanned line residual impedance value. If not already selected, it also switches the Calibrator to the Line Impedance function.

Query: SAF:LIN:SCAN?

[SOUR]:SAF:LOOP[:LEV](?) [<DNPD>]

Description: This command sets the resistance value as specified by DNPd for the Loop Impedance function. If not already selected, it also switches the Calibrator to the Loop Impedance function.

Parameters: <DNPd> The value of resistance in ohms. The Calibrator selects the closest resistance value.

Example: SAF:LOOP 0.1 Set the Loop Impedance function with 100 mΩ.

Query: SAF:LOOP? Returns the value of the resistance setting.

[SOUR]:SAF:LOOP:CORR(?) <CPD> {OFF | MAN | SCAN | COMP}

Description: This command sets the type of residual impedance correction for Loop Impedance specified by CPD. If not already selected, it also switches the Calibrator to the Loop Impedance function.

Parameters: <CPD> Type of residual impedance correction.
No = no correction.
MAN = manual correction.
SCAN = scanned correction.
COMP = compensated correction

Example: SAF:LOOP:CORR MAN Sets manual residual impedance correction mode.

Query: SAF:LOOP:CORR? Returns the type of residual correction mode selected.

[SOUR]:SAF:LOOP:POL?

Description: Returns the type of test signal generated by the UUT. If not already selected, it also switches the Calibrator to the Loop Impedance function.

Query: SAF:LOOP:POL? Returns type of test signal generated by DUT {POS | NEG | SYM | DCP | DCN | NO}

Types are:

 Test current is pulse (dc) with positive polarity (POS)

 Test current is pulse (dc) with negative polarity (NEG)

 Test current is symmetrical (ac) with positive phase (SYMP)

 Test current is symmetrical (ac) with negative phase (SYMN)

POS Test current is dc with positive polarity (DCP)

NEG Test current is dc with negative polarity (DCN)

NO is returned when the generated test signal is not valid.

[SOUR]:SAF:LOOP:CURRE?

- Description:** Returns the measured maximum value of peak current flowing through the selected resistance. If not already selected, it also switches the Calibrator to the Loop Impedance function.
- Query:** SAF:LOOP:CURRE?
- Note:** The maximum value can be cleared with the SAF:LOOP:CLE command.

[SOUR]:SAF:LOOP:CLE

- Description:** This command clears the maximum value of peak current. If not already selected, it also switches the Calibrator to the Line Impedance function.
- Example:** SAF:LINE:CLE

[SOUR]:SAF:LOOP[:CURRE]:PFC?

- Description:** Returns the value of prospective fault current. If not already selected, it also switches the Calibrator to the Loop Impedance function.
- Query:** SAF:LOOP:PFC?

[SOUR]:SAF:LOOP:MAN(?) <DNPD>

- Description:** This command sets the manual value of loop residual impedance. If not already selected, it also switches the Calibrator to the Loop Impedance function.
- Parameters:** <DNPD> The value of residual impedance in ohms.
- Example:** SAF:LOOP:MAN 0.87 Set manual compensation value to 0.87 Ω .
- Query:** SAF:LOOP:MAN? Returns the manual compensation value.

[SOUR]:SAF:LOOP:SCAN?

- Description:** Returns the scanned loop residual impedance value. If not already selected, it also switches the Calibrator to the Loop Impedance function.
- Query:** SAF:LOOP:SCAN?

[SOUR]:SAF:VOLT[:LEV](?) [<DNPD>]

- Description:** This command sets the output voltage to the value specified in DNPD. If not already selected, it also switches the Calibrator to the Voltage Calibration function.
- Parameters:** <DNPD> The value of generated voltage expressed in volts.
- Example:** SAF:VOLT 100 Set voltage calibration mode with a value 100 volts.
- Query:** SAF:VOLT? Returns the set voltage value.

[SOUR]:SAFE:VOLT:CURR?

Description: This command returns the measured load current value. If not already selected, it also switches the Calibrator to the Voltage Calibration function.

Query: SAF:VOLT:CURR?

[SOUR]:SAF:VOLT:FREQ(?) <DNPD>

Description: This command sets the frequency of the generated signal for ac Voltage Calibration function to the value specified in DNPD. If not already selected, it also switches the Calibrator to the Voltage Calibration function.

Parameters: <DNPD> The value of generated signal frequency expressed in Hertz.

Example: SAF:VOLT:FREQ 60 Sets the generated signal frequency to 60 Hz.

Query: SAF:VOLT? Returns the set frequency value.

[SOUR]:SAF:VOLT:FUNC(?) <CPD> {DC | AC}

Description: This command sets the voltage generated by the Calibrator to either ac or dc Voltage. If not already selected, it also switches the Calibrator to the Voltage Calibration function.

Parameters: <CPD> Type of voltage generation.
DC = dc voltage.
AC = ac voltage.

Example: SAF:VOLT:FUNC DC Sets voltage calibration function to dc voltage generation.

Query: SAF:VOLT:FUNC? Returns the type of voltage generation selected.

[SOUR]:SAF:VOLT:LOW(?) <CPD> {FLO | GRO}

Description: This command connects or disconnects the Output **LO** terminal to or from **GND** terminal. If not already selected, it also switches the Calibrator to the Voltage Calibration function.

Parameters: <CPD> FLO = Floating output
GRO = Grounded output

Example: SAF:VOLT:LOW GRO Sets the **LO** output terminal to grounded for voltage generation.

Query: SAF:VOLT:LOW? Returns the grounded output state, GRO or FLO.

[SOUR]:SAF:MET:FUNC(?) <CPD> {DC | AC}

Description: This command switches the meter function between ac and dc measurements. If not already selected, it also switches the Calibrator to the Meter function.

Parameters:	<CPD>	Type of voltage measurement. DC = dc measurements. AC = ac measurements.
Example:	SAF:MET:FUNC DC	Sets the Multimeter function to dc measurements.
Query:	SAF:MET:FUNC?	Returns the multimeter measurement selection.

[SOUR]:SAF:MET:PROB(?) <CPD> {OFF | 10KV | 40KV}

Description:	This command selects whether or not a high voltage probe is used for the meter function and if it is, which probe is used. If not already selected, it also switches the Calibrator to the Meter function.	
Parameters:	<CPD>	Type of voltage measurement. OFF = without probe. 10KV = multimeter with 10 kV probe. 40KV = multimeter with 40 kV probe.
Example:	SAF:MET:PROB 10KV	Sets the multimeter to measure with a 10 kV probe.
Query:	SAF:MET:PROB?	Returns whether the multimeter is measuring with a probe and if so, which probe is being used.

[SOUR]:SAF:MET:LOW(?) <CPD> {FLO | GRO}

Description:	This command connects or disconnects the Multimeter COM terminal to or from GND terminal. If not already selected, it also switches the Calibrator to the Meter function.	
Parameters:	<CPD>	FLO = floating output GRO = grounded output
Example:	SAF:MET:LOW GRO	Sets the LO multimeter terminal to grounded.
Query:	SAF:MET:LOW?	Returns the grounded output state of the COM Multimeter terminal, GRO or FLO.

[SOUR]:SAF:MET:CURR?

Description:	Returns the measured value of current. If not already selected, it also switches the Calibrator to the Meter function.	
Query:	SAF:MET:CURR?	

[SOUR]:SAF:MET:POW?

Description:	Returns the measured value of power. If not already selected, it also switches the Calibrator to the Meter function.	
Query:	SAF:MET:POW?	

[SOUR]:SAF:MET:VOLT?

Description:	Returns the measured value of voltage. If not already selected, it also switches the Calibrator to the Meter function.	
---------------------	--	--

Query: SAF:MET:VOLT?

[SOUR]:SAF:HIPL:FUNC(?) <CPD> {DC | AC}

Description: This command selects the dc or ac HIPOT leakage current mode.

Parameters: <CPD> ac = sets ac HIPOT leakage current mode
dc = sets dc HIPOT leakage current mode

Example: SAF:HIPL:FUNC AC Sets the ac HIPOT leakage current mode.

Query: SAF:HIPL:FUNC? Returns ac or dc state of the function.

Note: The command switches the calibrator in HIPOT leakage current function mode.

[SOUR]:SAF:HIPL:PROB(?) <CPD> {OFF | 10KV | 40KV}

Description: This command selects whether or not a high voltage probe is used for the meter function and if it is, which probe is used. If not already selected, it also switches the Calibrator to the Meter function.

Parameters: <CPD> Type of HIPOT leakage current measurement.
OFF = without probe.
10KV = with 10 kV probe.
40KV = with 40 kV probe.

Example: SAF:HIPL:PROB 10KV Sets the multimeter to measure with a 10 kV probe.

Query: SAF:HIPL:PROB? Returns whether the multimeter is measuring with a probe and if so, which probe is being used.

Note: The command switches the calibrator in HIPOT leakage current function mode.

[SOUR]:SAF:HIPL:CURR?

Description: Returns the measured value of current using standard exponential format. For example, 2.15 mA is returned as 2.150000e-003. If not already selected, it also switches the Calibrator to the HIPOT leakage current function.

Query: SAF:MET:CURR?

[SOUR]:SAF:HIPL:VOLT?

Description: Returns the measured value of voltage using standard exponential format. For example, 230 V is returned as 2.300000e+002. If not already selected, it also switches the Calibrator to the HIPOT leakage current function.

Query: SAF:HIPL:VOLT?

[SOUR]:SAF:HIPT:FUNC(?) <CPD> {DC | AC}

Description: This command selects the dc or ac HIPOT timer mode.

Parameters: <CPD> ac = sets ac HIPOT timer mode
dc = sets dc HIPOT timer mode

- Example:** SAF:HIPT:FUNC AC Sets the ac HIPOT timer mode.
Query: SAF:HIPT:FUNC? Returns ac or dc state of the function.
Note: The command switches the calibrator to HIPOT timer function mode.

[SOUR]:SAF:HIPT:TIME?

Description: This command returns the time measurement using standard exponential format. 2.15 mA is returned as 2.150000e-003. If not already selected, it also switches the Calibrator to the HIPOT leakage current function. If not already selected, it also switches the Calibrator to the HIPOT timer function.

Query: SAF:HIPT:TIME?

[SOUR]:SAF:HIPT:VOLT?

Description: Returns the measured value of voltage using standard exponential format. For example, 230 V is returned as 2.300000e+002. If not already selected, it also switches the Calibrator to the HIPOT timer function.

Query: SAF:HIPT:VOLT?

[SOUR]:SAF:HIPT:[VOLT]:MAX?

Description: Returns the maximum peak measured value of voltage using standard exponential format. For example, 230 V is returned as 2.300000e+002. Use the SAF:HIPT:CLEar command to clear the maximum value. If not already selected, it also switches the Calibrator to the HIPOT timer function.

Query: SAF:HIPT:MAX?

[SOUR]:SAF:HIPT:CLE?

Description: Clears the measured time and maximum peak value of measured voltage. If not already selected, it also switches the Calibrator to the HIPOT timer function.

Example: SAF:HIPT:CLE

Using SYSTem Commands

The SYSTEM commands are used to read and control miscellaneous Calibrator functions.

SYSTem

- DATE (?) <DNPD>,<DNPD>,<DNPD>
- TIME (?) <DNPD>,<DNPD>,<DNPD>
- ERRor?
- REMOte
- RWLock
- LOCal

SYST:DATE(?) <DNPD>,<DNPD>,<DNPD>

- Description:** This command sets the system date of the Calibrator.
- Parameters:** <DNPD> Year as YYYY
 <DNPD> Month as MM
 <DNPD> Day as DD.
- Example:** SYSR:DATE 2006,11,05 Sets the Calibrator's date function to November 11, 2006.
- Query:** SAF:DATE? Returns the date in the Calibrator.

SYST:TIME(?) <DNPD>,<DNPD>,<DNPD>

- Description:** This command sets the system time of the Calibrator.
- Parameters:** <DNPD> Hour as HH (00 to 23)
 <DNPD> Minutes as MM (00 to 59)
 <DNPD> Seconds as SS (00 to 59).
- Example:** SYSR:TIME 15,36,14 Sets the Calibrator's time function to 15 hours, 36 minutes and 14 seconds (3:36:14 PM).
- Query:** SAF:TIME? Returns the time in the Calibrator.

SYST:ERR?

- Description:** This command queries the Calibrator's error queue to retrieve the first error in the queue. The error queue stores errors as first-in first-out (FIFO). The error is deleted after being read. In the case of error queue overflow, the last error in the queue is -350, "Queue overflow". The earliest errors remain in the queue, while the most recent error is discarded.
- Query:** SYST:ERR? Returns first error in the error queue as an error code followed by an error message.

SYST:REM

- Description:** This command sets the Calibrator in remote mode for remote control through the RS-232 or Ethernet ports. All keys on the front panel except the LOCAL key are disabled.

Note

It is not possible to send or receive data over the RS-232 or Ethernet ports when the calibrator is not in remote mode.

SYST:RWL

- Description:** This command sets the Calibrator in remote mode for remote control through the RS-232 or Ethernet ports. All keys on the Calibrator's front panel except the LOCAL key, are disabled.

SYST:LOC

- Description:** This command returns the calibrator to the local mode. This command is used only when controlling the Calibrator through the RS-232 or Ethernet ports.

Using the STATus Subsystem

This subsystem is used to enable bits in the Operation and Questionable Event registers. The Operation and Questionable Event, Enable and Condition registers can be interrogated to determine their state. Table 5-6 give a summary of the Calibrator's STATUS commands.

STAT:OPER:EVEN?

Description: This query command returns the content of Operational Data Event register. It is a decimal value which corresponds to the binary-weighted sum of all bits set in the register. Register is cleared after this query.

STAT:OPER:ENAB? <DNPD>

Description: This command enables bits in the Operational Data Enable register. Selected bits are summarized at bit 7 (OSS) of the IEEE 488.2 Status Byte register.

Parameters: <DNPD> Represents the register bits as a decimal number.

Example: STAT:OPER:ENAB 2 Sets bit 1 of the Operational Data Enable register while all other bits are set to 0.

Query: SAF:OPER:ENAB? Returns the value of the Operational Data Enable register as a decimal value.

STAT:OPER:COND?

Description: This query command returns the content of the Operational Condition register. It's decimal value corresponds to the binary-weighted sum of all bits set in the register. Register is not cleared after this query. The response to the query therefore represents an instantaneous snapshot of the register state, at the time that the query was accepted.

STAT:QUES:EVEN?

Description: This query command returns the content of Questionable Data Event register. It is a decimal value which corresponds to the binary-weighted sum of all bits set in the register. Register is cleared after this query.

STAT:QUES:ENAB? <DNPD>

Description: This command enables bits in the Questionable Data Enable register. Selected bits are summarized at bit 3 (OSS) of the IEEE 488.2 Status Byte register.

Parameters: <DNPD> Represents the register bits as a decimal number.

Example: STAT:QUES:ENAB 2 Sets bit 1 of the Questionable Data Enable register, while all other bits are set to 0.

Query: SAF:QUES:ENAB? Returns the value of the Questionable Data Enable register as a decimal value.

STAT:QUES:COND?

Description: This query command returns the content of Questionable Condition register. It is a decimal value which corresponds to the binary-weighted sum of all bits set in the register. The register is not cleared after this query. The response to the query therefore represents an instantaneous Snapshot of the register state, at the time that the query was accepted.

STAT:PRES

Description: This query command clears all bits in the Operation Data Enable register and in the Questionable Data Enable register.

Using IEEE 488.2 Common Commands

The following commands are common to the IEEE 488.2 standard. A summary of the Calibrator's IEEE Common Commands are listed in Table 5-7.

***IDN?**

Description: This query command returns the manufacturer's name, model number, serial number, and firmware revision of the Calibrator.

The reply is formatted as follows:

FLUKE,5320A,100002,1.12+1.01+1.01+1.02

***OPC**

Description: This command sets the OPC bit in the ESR (Event Status Register) when all pending operations are complete.

***OPC?**

Description: This command returns "1" to the output queue after all pending operations are complete.

***WAI**

Description: This command prevents the Calibrator from executing any further commands or queries until all previous remote commands have been executed.

***RST**

Description: This command resets the Calibrator to its initial state.

***TST?**

Description: This command launches an internal self-test and returns the self-test results ("0" = pass or "1" = fail).

***STB?**

Description: This query command returns a number representing the STB register contents. The STB register carries the MSS bit status.

***SRE <value>**

Description: This command sets the Service Request Enable register. Since bit 6 is not used, the maximum value is 191.

***SRE?**

Description: This query command returns the Service Request Enable Register number.

***ESR?**

Description: This query command returns the contents of the Event Status Register and clears the register.

***ESE <value>**

Description: This command programs the Event Status Enable register bits. Parameter value is a number in the range of 0 – 255.

***ESE?**

Description: This query command returns the value in the Event Status Enable register.

***CLS**

Description: This command clears the Event Status Register and the Status Byte Register with the exception of the MAV bit and output queue. The output line is not reset.

Standard Status Data Structures

The Calibrator meets the standard protocol according to the IEEE 488.2 standard. This protocol is used for checking for error and status behavior of the calibrator. It enables single-wire transmission of the SRQ command. The conditions on which the SRQ signal (local control request) is sent, is set with parameters *STB?, *SRE?, *SRE, *ESR?, *ESE?, *ESE a *CLS.

As shown in Figure 5-1, the status data structure contains the following registers:

- STB – Status Byte Register
- SRE – Service Request Enable Register
- ESR – Event Status Register
- ESE – Event Status Enable Register
- Output Queue

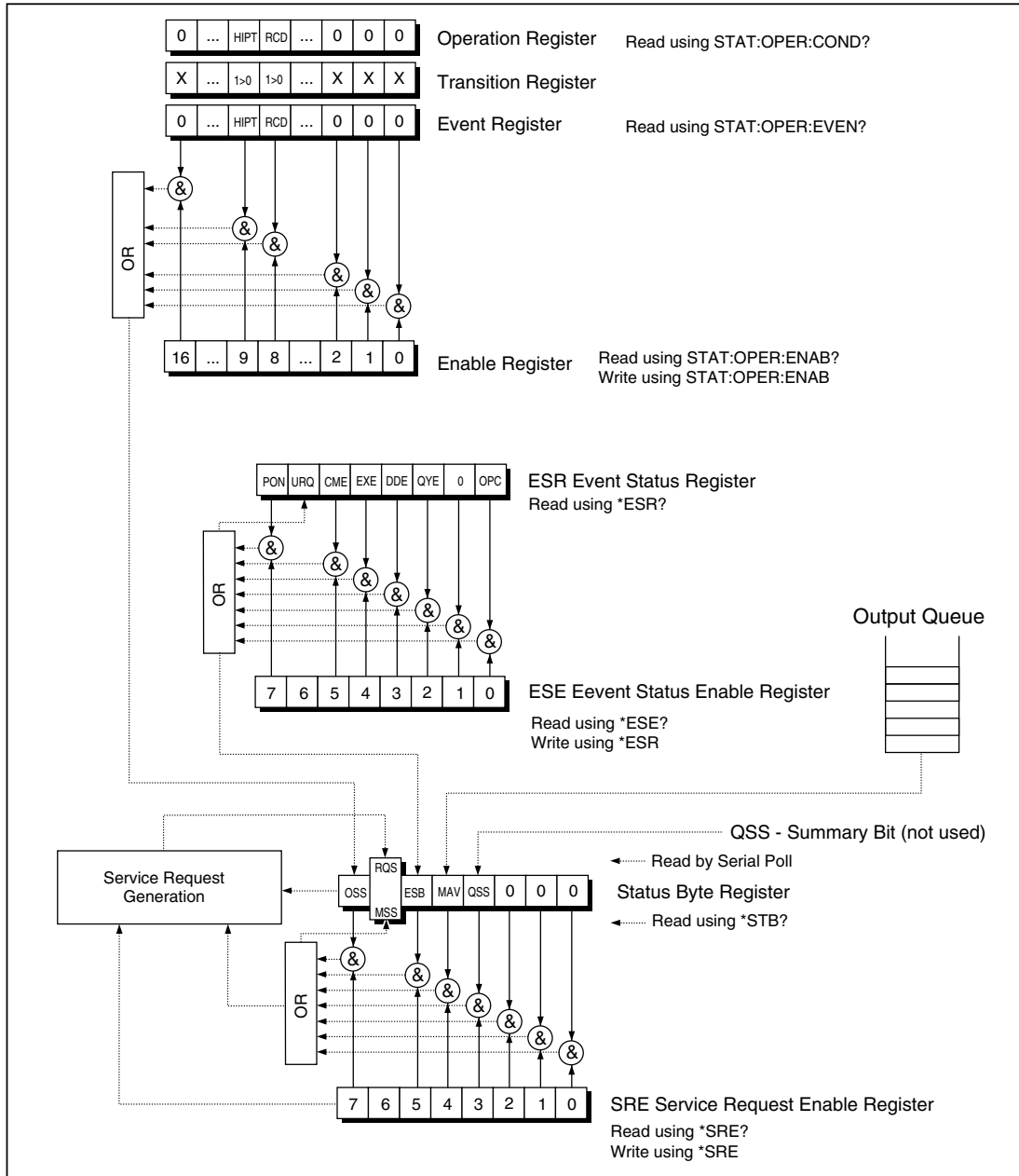

ehq071.eps

Figure 5-1. Status Register Overview

STB Status Byte Register

The Status Byte (STB) register is the main register where information from other status registers and from the output queue are collected. The value of STB register is reset after powering up the Calibrator, or after sending the *CLS command. This command resets all STB bits except the MAV bit, which remains set if the output queue is not empty. The STB register value can be read via a serial message or the general query *STB?.

Table 5-8. Bit Configuration of the Status Byte Register

Bit Name	Description
OSS	Operation Summary Status (bit 7). SCPI-defined. The OSS bit is set to 1 when the data in the OSR (Operation Status Register) contains one or more enabled bits which are true.
RQS	Request Service (bit 6). The bit is read as a part of status byte only when serial message is sent.
MSS	Master Summary Status (bit 6). The MSS bit is set to 1 whenever bits ESB or MAV are 1 and enabled (1) in the SRE. This bit can be read using the *STB? Command. This value is derived from STB and SRE status.
ESB	Event Summary Bit (bit 5). This value is derived from STB and SRE status. The ESB bit is set to 1 when one or more enabled ESR bits are set to 1.
MAV	Message Available (bit 4). The MAV bit is set to 1 whenever data is available in the IEEE 488 Output Queue (the response on query is "ready").
QSS	Questionable Summary Status (bit 3). SCPI-defined. The QSS bit is set to 1 when the data in the QSR (Questionable Status Register) contains one or more enabled bits which are true.

SRE Service Request Enable Register

The SRE Register is an 8-bit register that enables or disables (masks) corresponding summary messages in the Status Byte Register.

The meter may be programmed to make a service request on errors, questionable data, or when output is available. Conditions that trigger a service request are specified by writing a binary weighted value to the SRE Register, using the *SRE command.

If any bit in the SRE is set to 1, the RQS bit (bit 6) in the Status Byte Register is enabled, meaning a service request can be generated when the appropriate bits in STB become 1. At power-up, or on any device-clear command, the SRE Register is set to 00 (decimal). The register is not reset by the *CLS command.

ESR Event Status Register

Every bit of the Event Status Register corresponds to one event. Bit is set when the event is changed and it remains set also when the event passed. The ESR is cleared when the power is turned on (except bit PON which is set), and every time it is read via command *ESR? or cleared with *CLS.

Table 5-9. Bit Configuration of the Event Status Register

Bit Name	Event Description
PON	Power On (bit 7). This bit is set to “1” when an off-to-on transition has occurred in the Calibrator’s power supply.
URQ	User Request (bit 6). This bit is not used by the Calibrator. It is always a “0”.
CME	Command Error (bit 5). This bit is set to “1” whenever a incorrectly formatted command or query has been detected by the Calibrator.
EXE	Execution Error (bit 4). This bit is set to “1” whenever a received command can NOT be executed, owing to the device state or the command parameter is out of limits.
DDE	Device Dependent Error (bit 3). This bit is set to “1” whenever the Calibrator detects an error that is not a command error, a query error, nor an execution error. A device-specific error is any excuted Calibrator operation that did not properly complete due to some condition, such as an overload.
QYE	Query Error (bit 2). This bit is set to “1” whenever the Calibrator is addressed as a talker and the output queue is empty, or if the control unit did not pick up a response before sending the next query.
OPC	Operation Complete (bit 0). This bit is set in response to the *OPC command. It indicates the Calibrator has completed all selected pending operations.

ESE Event Status Enable Register

The Event Status Enable Register allows one or more events in the Event Status Register to be reflected in the ESB summary-message bit. This register has 8 bits, each corresponding to the bits in the Event Status Register. The Event Status Enable Register is read with the common query *ESE?. Data is returned as a binary-weighted value. The Event Status Enable Register is written to by the common command, *ESE. Sending the *ESE common command followed by a zero clears the ESE. The Event Status Enable Register is cleared upon power-on.

The ESE register suppresses or allows bits in ESR register. A value of “0“ in a bit of the ESE register suppresses (masks) the influence of the appropriate bit in the ESR register. Setting of any unmask bit of the ESR register results in setting of the ESB status register. The ESE register value can be modified by the *ESE command followed by the value of the mask register (integer in range 0 –255). Reading of the register can be performed with the *ESE? command. The register is automatically reset after powering up the Calibrator. The register is not reset with *CLS command.

Operation Status Register

The following “sticky” bits in the Operation register are set by their associated conditions. Bit 8 is set when RCD trip current has been reached and time counting is in progress. The setting to the Transition Filter is fixed (1 → 0 change). Bit 8 in the Event Register is set after the RCD Trip Time has expired.

Questionable Status Register

Not used in the Calibrator.

Output Queue

The Output Queue stores response messages until they are read. If there is at least one character in the output queue, the MAV register (message available) is set. The Output Queue is cleared upon power-on and after reading all characters from the output queue.

Error Queue

The Error Queue stores error messages. They are queued on a first-in first-out (FIFO) basis.

The error queue is read destructively using the query command “SYSTem:ERRor?” to obtain a code number and error message. The query “SYSTem:ERRor?” can be used to read errors in the queue until it is empty, when the message “0, No Error” will be returned.

IEEE 488 Interface Configuration

The calibrator’s IEEE 488 interface supports the IEEE 488 interface function subsets listed in Table 5-10.

Table 5-10. Supported IEEE 488 Interface Function Subsets

Interface Function	Description
SH1	Complete sourced handshake capability
AH1	Complete acceptor handshake capability
T5	
L3	
RL1	
DC1	
SR1	
DCL	Device clear (resets the Calibrator)
SDC	Selected device clear (resets the Calibrator)
EOI	End or Identify message terminator (close the message)
GTL	Go To Local (close remote control mode)
LLO	Local Lock Out (local control locked)
SPD	Serial Poll Disable (close serial message status)
SPE	Serial Poll Enable (release serial message status)

Chapter 6

Operator Maintenance

Title	Page
Introduction.....	6-3
Accessing the Fuses	6-3
Line-Power Fuse.....	6-3
Measurement Input Fuses.....	6-4
Cleaning the Air Filter	6-4
Cleaning the Exterior	6-5
What to Do In Case of Calibrator Failure	6-5
Verifying Calibrator Operation.....	6-6
Preparing for Calibrator Verification	6-6
Performing Calibrator Verification	6-6
Low Resistance Source Verification	6-7
High Resistance Source Verification	6-8
Resistance Multiplier Verification	6-10
Ground Bond Resistance Source Verification	6-11
Leakage Current Verification.....	6-14
RCD Trip Current Verification	6-15
RCD Trip Current Meter Verification.....	6-16
RCD Trip Time Verification	6-17
AC Voltage Calibrator Verification	6-18
DC Voltage Calibrator Verification	6-19
Meter Verification	6-19
HV Probe Verification	6-20

Introduction

This chapter explains how to perform the routine maintenance and calibration tasks required to keep your Calibrator in optimal operating condition. The tasks covered in this chapter include the following:

- Replacing the fuse
- Cleaning the air filter and external surfaces
- Verifying the operation of the Calibrator

There are no user serviceable items within the Calibrator. For intensive maintenance tasks such as repair, contact the Fluke service center.

The Calibrator should be calibrated annually.

Accessing the Fuses

The Calibrator uses fuses to protect both the line-power input and various front-panel terminals of the Calibrator. The following sections describe the replacement procedures and lists the appropriate fuses used in the Calibrator.

Line-Power Fuse

The Calibrator has a line-power fuse in series with the power supply. Table 6-1 indicates the proper fuse for each line voltage selection.

To replace the line power fuse:

1. Unplug the power cord from the Calibrator.
2. Locate the fuse holder labeled “Power Fuse” on the rear panel of the Calibrator (see Table 3-2, item 2).
3. Using a flat-blade screwdriver in the slot on the end of the fuse holder, unscrew the fuse holder.
4. Replace the fuse with one rated for the selected line voltage. See Table 6-1.
5. Reinsert the fuse holder and screw it into the socket.

Warning

To avoid electric shock or fire, do not use makeshift fuses or short-circuit the fuse holder.

Table 6-1. Line Power Fuses

Line Voltage Selection	Fuse	Fluke Part No.
115 V	T4L250V (5 x 20 mm)	2743488
230 V	T2L250V (5 x 20 mm)	2743495

Measurement Input Fuses

The Amps (A) terminal of the METER input, the HI terminal of the OUPUT terminals, and the L terminal or the RCD terminals are protected by fuses at the rear of the Calibrator.

To replace these fuses:

1. Unplug all connections to the front panel of the Calibrator.
2. Unplug the power cord from the Calibrator.
3. Locate the fuse holder for the function on the rear panel of the Calibrator (see Table 3-2, item 3).
4. Using a flat-blade screwdriver in the slot on the end of the fuse holder, unscrew the fuse holder.
5. Replace the fuse with one rated for the selected function. See Table 6-2.
6. Reinsert the fuse holder and screw it into the socket.

⚠ Caution

To avoid damaging the Calibrator, use only the fuse specified for each of the measurement inputs as listed in Table 6-2.

Table 6-2. Measurement Input Fuses

Input	Fuse	Fluke Part No.
RCD	F3.15L250V (5 x 20 mm)	2743508
Leakage Current	F100mL150V (5 x 20 mm)	2743513
Meter	T20L500V (6.3 x 32 mm)	2743536
Loop/Line Impedance	T4L250V (6.3 x 32 mm)	2743524

Cleaning the Air Filter

⚠ Caution

Damage caused by overheating may occur if the area around the fan is restricted, the intake air is too warm, or the air filter becomes clogged.

The air filter must be removed and cleaned at least every 30 days, or more frequently if the calibrator is operated in a dusty environment. The air filter is accessible from the rear panel of the Calibrator.

To clean the air filter, proceed as follows:

1. Unplug all connections to the front panel of the Calibrator.
2. Unplug the power cord from the Calibrator.
3. Remove the filter by grasping the outside edges of the filter and pulling straight out.
4. Remove the filter element from the filter frame.
5. Clean the filter by washing it in soapy water. Rinse and dry the filter element thoroughly before reinstalling.
6. Reinstall the filter element into the filter frame.
7. Snap the filter frame back on to the fan housing.

Cleaning the Exterior

To keep the calibrator looking like new, clean the case, front panel keys, and lens using a soft cloth slightly dampened with either water or a non-abrasive mild cleaning solution that is not harmful to plastics.

⚠ Caution

Do not use aromatic hydrocarbons or chlorinated solvents for cleaning. They can damage the plastic materials used in the Calibrator.

What to Do In Case of Calibrator Failure

If an obvious failure occurs during operation (e.g. the display is not lit, the fan is not turning), the Calibrator must be powered off immediately. First, check the line power fuse located on the rear panel of the Calibrator. See “Accessing the Fuses” earlier in this Chapter.

If a Calibrator range or an operating mode is not functioning and the user cannot correct the fault, contact the Fluke Service Center.

Subtle faults can cause different symptoms and have different causes. Usually, they cause instability of some parameter. Subtle defects can be caused by events such as unacceptable distortion or degraded insulation etc. In this case contact the Fluke Service Center.

If the rules for correct operation are not adhered to, it may seem as if the calibrator has a subtle defect. Some abnormalities may actually be due to circumstances outside of the Calibrator, or operator error. See “Preparing the Calibrator for Operation” in Chapter 2 of this manual. Most frequent cases of defects are:

- Mains voltage out of tolerance limits, unstable, distorted voltage or there are voltage spikes present.
- Incorrect grounding of the mains circuit (bad connection of the ground terminal of the mains outlet).
- Proximity to sources that have either high conducted or radiated electromagnetic fields.
- Strong electrostatic or electromagnetic fields which can cause major instability during usage, particularly when working with high impedance ($>1 \text{ M}\Omega$).

Verifying Calibrator Operation

The following sections describe the procedure used to verify the Calibrator is operating correctly and within specifications. Ensure the Calibrator has been in a temperature stable environment for at least 8 hours before starting the verification process.

Preparing for Calibrator Verification

Table 6-3 lists the equipment required to perform Calibrator verification.

Table 6-3. Required Verification Test Equipment

Test Equipment	Recommended Model
Multimeter with 4-wire ohms capability	Fluke 8508A or equivalent
Megohmmeter with 3 test leads	Quadtech 1865 or equivalent
Multifunction calibrator	Fluke 5520A or equivalent
Frequency counter	Fluke PM 6690 or equivalent
Distortion analyzer	HP/Agilent 8903B or equivalent
10 kV/40 kV High Voltage DC source ^[1]	Fluke 410B or equivalent
10 kV/40 kV High Voltage AC source ^[1]	Generic High Voltage AC Source

[1] Used to complete optional tests for the 10 kV and 40 kV probes.

Power up the Calibrator and test equipment and ensure power has been applied for at least one hour before starting the verification process.

Performing Calibrator Verification

The Calibrator verification procedure consists of the following basic steps:

- Low resistance source
- High resistance source
- Ground bond (and loop/line impedance) resistance source
- Leakage current ac ranges 300 uA, 3 mA, 30 mA
- RCD trip current
- RCD trip time
- Calibrator ac/dc voltage on ranges 30 V ac, 100 V ac, 300 V ac, 600 V ac, 100 V dc, 600 V dc (5320A/VLC models only)
- Multimeter voltage ranges 10 V, 100 V, 1000 V
- Multimeter current ranges 300 mA, 3 A, 30 A
- Frequency nominal value 400 Hz
- Hipot leakage current
- 10 kV ac/dc voltage divider verification
- 40 kV ac/dc voltage divider verification (5320A with 40 kV option)

After connecting the Calibrator to the power mains, turn power on and let the Calibrator warmup for at least one hour in a laboratory with a temperature of 23 ± 5 °C before proceeding with the verification.

The following steps use measuring points that are specified in Tables 6-4 to 6-16.

Low Resistance Source Verification

1. Connect the low resistance source output to a standard multimeter as shown in Figure 6-1. Use a 4-wire connection and setup the multimeter for a 4-wire ohms measurement.

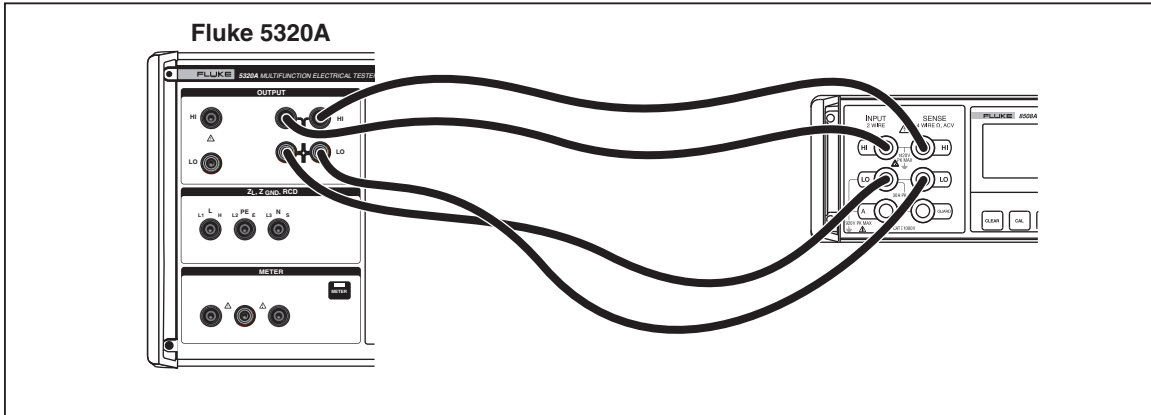

Figure 6-1. Low Resistance Calibration Connections

ewt023.eps

2. Press $\overline{LO\Omega}$ on the Calibrator.
3. Press the **Mode** softkey. Then, using the cursor keys or rotary knob, highlight **Resistance 4-Wire** and select it by pressing **Select** or pushing in on the rotary knob.
4. Set the multimeter for true ohms and auto range.
5. Verify the Calibrator's Low Resistance calibration performance at each resistance point listed in Table 6-4. Deviations should not exceed the specified limits.

Table 6-4. Low Resistance Source Limits

Nominal Value (Ohm)	Required Standard Ohmmeter Accuracy	Lower Limit (Ohm)	Upper Limit (Ohm)
0.100 Ω	0.02 %	89.7 m Ω	110.3 m Ω
0.200 Ω	0.02 %	189.6 m Ω	210.6 m Ω
0.400 Ω	0.02 %	388.8 m Ω	411.2 m Ω
1.000 Ω	0.02 %	987.0 m Ω	1013.0 m Ω
2.000 Ω	0.02 %	1.984 Ω	2.016 Ω
4.000 Ω	0.02 %	3.978 Ω	4.022 Ω
8.000 Ω	0.02 %	7.974 Ω	8.026 Ω
10.00 Ω	0.02 %	9.970 Ω	10.030 Ω
20.00 Ω	0.02 %	19.95 Ω	20.05 Ω
40.00 Ω	0.02 %	39.92 Ω	40.08 Ω
80.00 Ω	0.02 %	79.84 Ω	80.16 Ω
100.0 Ω	0.02 %	99.80 Ω	100.20 Ω
200.0 Ω	0.02 %	199.6 Ω	200.4 Ω
400.0 Ω	0.02 %	399.2 Ω	400.8 Ω
800.0 Ω	0.02 %	798.4 Ω	801.6 Ω
1000 Ω	0.02 %	998.0 Ω	1002.0 Ω

Table 6-4. Low Resistance Source Limits (cont.)

Nominal Value (Ohm)	Required Standard Ohmmeter Accuracy	Lower Limit (Ohm)	Upper Limit (Ohm)
2000 Ω	0.02 %	1996 Ω	2004 Ω
4000 Ω	0.02 %	3992 Ω	4008 Ω
8000 Ω	0.02 %	7984 Ω	8016 Ω
10000 Ω	0.02 %	9980 Ω	10020 Ω

High Resistance Source Verification

1. Connect the high resistance source output to a standard megohmmeter's input terminals as shown in Figure 6-2. Setup the appropriate megohmmeter parameters to meet its best accuracy. Do not exceed the maximum permitted test voltage.

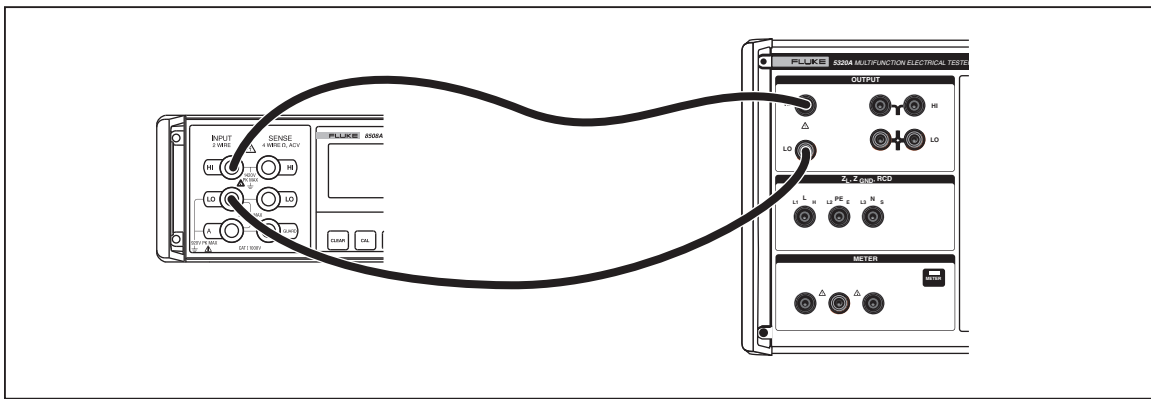

ewt070.eps

Figure 6-2. High Resistance Source (<10 M Ω) Calibration Connections

2. Press **HI Ω** on the Calibrator.
3. Set the multimeter for normal 2-wire ohms measurement and auto range.
4. Verify the Calibrator's High Resistance calibration performance at each resistance point listed in Table 6-5. Deviations should not exceed the specified limits.

Note

For some megohmmeters, when using the Calibrator's 100 G Ω value or when using the resistance multiplier adapter, the leads must be swapped between the calibrator's HI and LO ohms resistance output. The ground must be turned on (Gnd On) when swapping HI and LO lead positions in the high ohms resistance function. For example, to make a proper measurement with the Quadtech 1865 Megohmmeter, connect the HI terminal on the megohmmeter to the LO terminal on the Calibrator and connect the LO terminal on the megohmmeter to the HI terminal on the calibrator. Turn the ground on and proceed to make the measurement.

Table 6-5. High Resistance (<10 MΩ) Source Limits

Nominal Value (Ohm)	Required Standard Ohmmeter Accuracy	Lower Limit (Ohm)	Upper Limit (Ohm)
10 kΩ	0.02 %	9.98 kΩ	10.02 kΩ
20 kΩ	0.02 %	19.96 kΩ	20.04 kΩ
40 kΩ	0.02 %	39.92 kΩ	40.08 kΩ
80 kΩ	0.02 %	79.84 kΩ	80.16 kΩ
100 kΩ	0.02 %	99.80 kΩ	100.20 kΩ
200 kΩ	0.02 %	199.6 kΩ	200.4 kΩ
400 kΩ	0.02 %	399.2 kΩ	400.8 kΩ
800 kΩ	0.02 %	798.4 kΩ	801.6 kΩ
1.00 MΩ	0.05 %	997.0 kΩ	1003.0 kΩ
2.00 MΩ	0.05 %	1.994 MΩ	2.006 MΩ
4.00 MΩ	0.05 %	3.988 MΩ	4.012 MΩ
8.00 MΩ	0.05 %	7.976 MΩ	8.024 MΩ
10.0 MΩ	0.1 %	9.95 MΩ	10.05 MΩ

- Connect the Calibrator directly to the megohmmeter as shown in Figure 6-3.

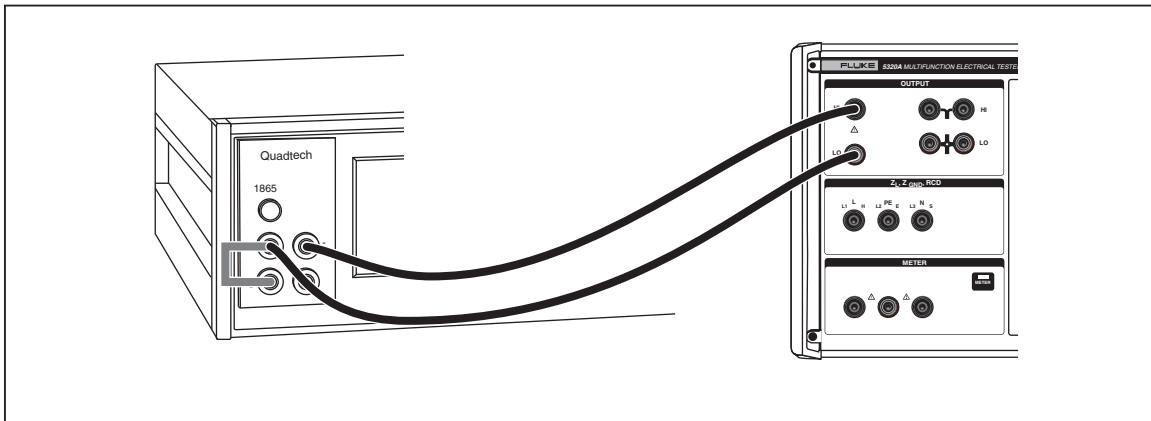

Figure 6-3. High Resistance Source (>10 MΩ) Calibration Connections

ewt071.eps

- Setup the megohmmeter as follows:
 - Voltage = 500
 - Charge time = 5
 - Dwell time = 5
 - Measure time = 20
 - Discharge time = 5
 - Mode = Auto
 - Number to average = 400
- Verify the Calibrator's High Resistance calibration performance at each resistance point listed in Table 6-6. Deviations should not exceed the specified limits.

Table 6-6. High Resistance (>10 MΩ) Source Limits

Nominal Value (Ohm)	Required Standard Ohmmeter Accuracy	Lower Limit (Ohm)	Upper Limit (Ohm)
20.0 MΩ	0.1 %	19.9 MΩ	20.1 MΩ
40.0 MΩ	0.1 %	39.8 MΩ	40.2 MΩ
80.0 MΩ	0.1 %	79.6 MΩ	80.4 MΩ
100 MΩ	0.2 %	99.5 MΩ	100.5 MΩ
200 MΩ	0.2 %	199 MΩ	201 MΩ
400 MΩ	0.2 %	398 MΩ	402 MΩ
800 MΩ	0.2 %	796 MΩ	804 MΩ
1.0 GΩ	0.5 %	990 MΩ	1.010 MΩ
2.0 GΩ	0.5 %	1.98 GΩ	2.02 GΩ
4.0 GΩ	0.5 %	3.96 GΩ	4.04 GΩ
8.0 GΩ	0.5 %	7.92 GΩ	8.08 GΩ
100 GΩ	1.0 %	Rdisplayed - 3.0 % ^[1]	Rdisplayed + 3.0 % ^[1]
[1] Maximum deviation from calibration value.			

Resistance Multiplier Verification

Note

To ensure low leakage, place the kV Divider/R Multiplier on an insulated surface (Teflon sheet or glass).

1. Connect the Calibrator to a megohmmeter through the HV Adapter using low-leakage, low-dielectric absorption test leads as shown in Figure 6-4. Note the polarity of the connections between the kV Divider/R Multiplier output to the Calibrator, HIΩ Multiplier to the Calibrator HIΩ, mA terminals are reversed.

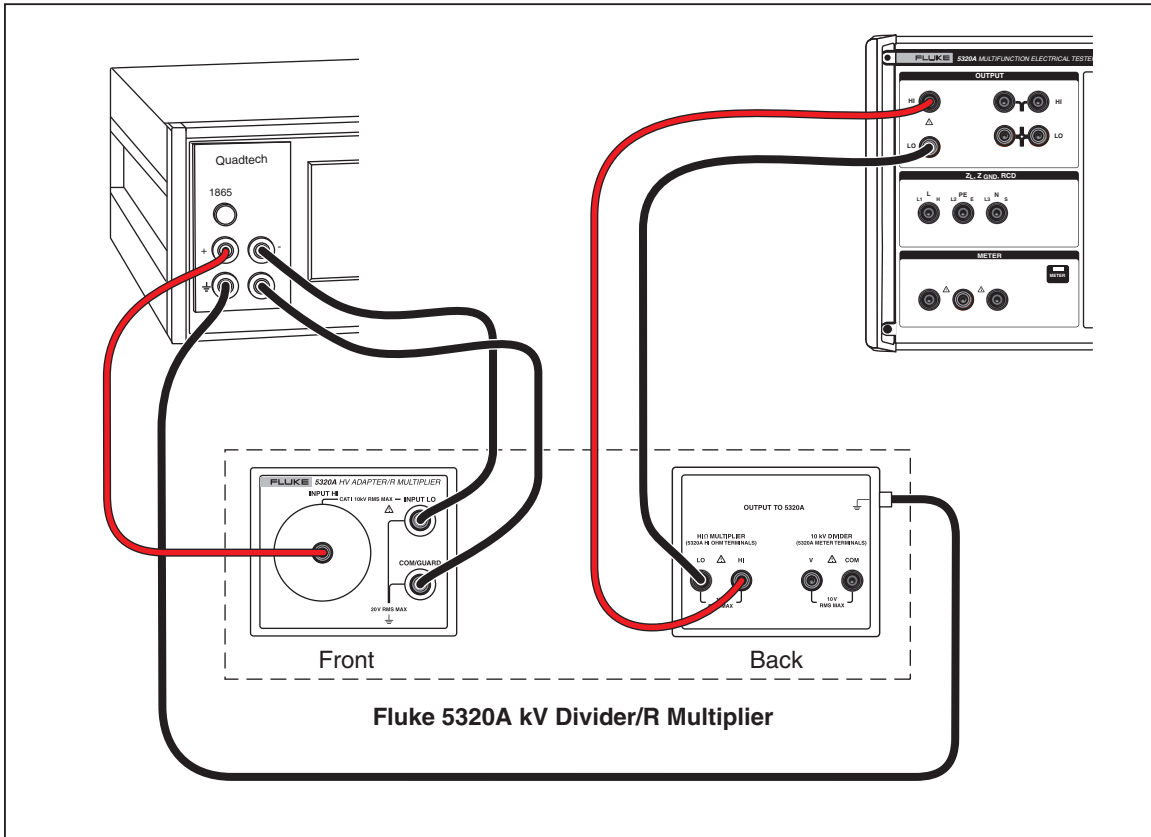

Figure 6-4. Resistance Multiplier Verification Connections

ewt090.eps

Note

Minimize physical movement in the vicinity of the UUT and megohmmeter during the following measurement sequence.

2. Press the softkey labeled **R Mult.** on the Calibrator.

Table 6-7. Resistance Limits for Multiplier Verification

Nominal Value (Ohm)	Required Standard Ohmmeter Accuracy	Lower Limit (Ohm)	Upper Limit (Ohm)
1.0 GΩ ^[1]	0.2 %	0.987 GΩ	1.013 GΩ
10 GΩ ^[1]	0.2 %	9.85 GΩ	10.15 GΩ
100 GΩ ^[1]	0.5 %	97.5 GΩ	102.5 GΩ
1.0 TΩ ^[1]	1 %	0.97 TΩ	1.03 TΩ
9 TΩ ^[1]	1 %	8.64 TΩ	9.36 TΩ

[1] With resistance multiplier adapter.

Ground Bond Resistance Source Verification

Verification using a standard ohmmeter with test current of 100 mA is adequate for ground bond decade verification for resistors greater than 1.8 ohms. Resistors less than or equal to 1.8 ohms use higher current stimulus which is more representative of the Calibrator's instrument workload.

Resistance < 5 Ohms

1. Connect the Calibrator to the multimeter and multifunction calibrator as shown in Figure 6-5.

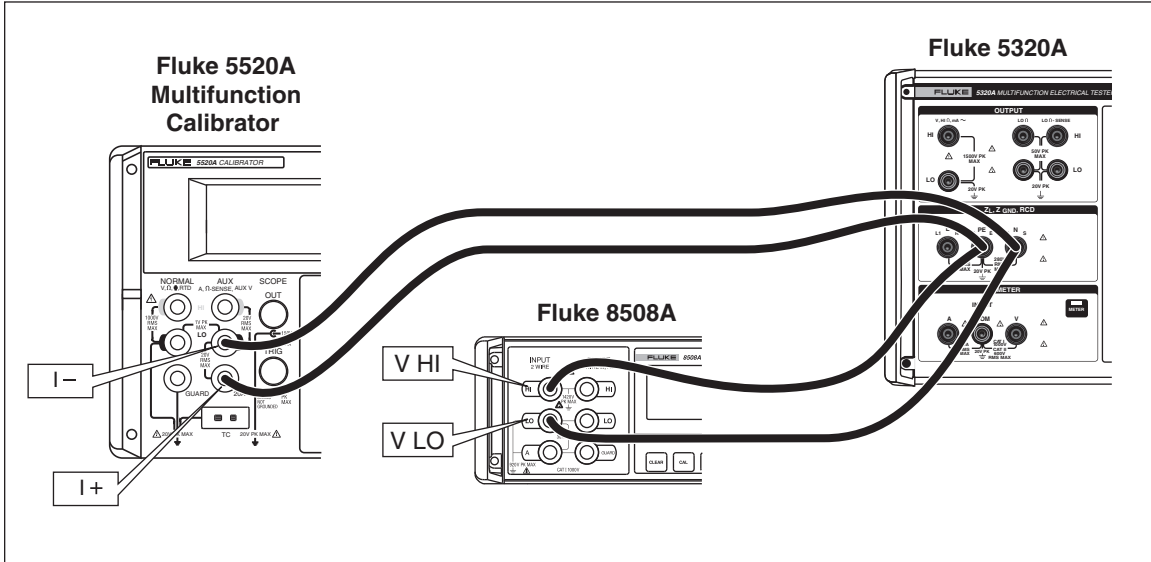

Figure 6-5. High Current Bond Resistance Connections

ehq072.eps

2. Set the test current on the multifunction calibrator to the DC test current in Table 6-8 and measure the voltage drop between the PE and N terminals on the Calibrator ($V_{\text{multimeter}}$)
3. Calculate ground bond resistance:

$$R_{\text{gbr}} = V_{\text{multimeter}} / I_{5520A}$$
4. Compare the calculated Rgbr with the value displayed on the Calibrator. Both values should be within the lower and upper limit values in Table 6-8.

Table 6-8. High Test Current Ground Bond Source Limits

Nominal Value	Required Standard Calibrator/Multimeter Current/Voltage Uncertainty	DC Test Current	Lower Limit ^[1]	Upper Limit ^[1]
25 mΩ	± 0.5%	20 A	Rgbr - 5 mΩ	Rgbr + 5 mΩ
50 mΩ	± 0.2 %	10 A	Rgbr - 5 mΩ	Rgbr + 5 mΩ
100 mΩ	± 0.1 %	10 A	Rgbr - 5 mΩ	Rgbr + 5 mΩ
330 mΩ	± 0.1 %	5 A	Rgbr - 7 mΩ	Rgbr + 7 mΩ
500 mΩ	± 0.1 %	3 A	Rgbr - 8 mΩ	Rgbr + 8 mΩ
1 Ω	± 0.1 %	2 A	Rgbr - 10 mΩ	Rgbr + 10 mΩ
1.8 Ω	± 0.1 %	2 A	Rgbr - 18 mΩ	Rgbr + 18 mΩ

[1] Maximum deviation from calibration value.

Resistance > 1.8 Ohms

1. Connect four test leads to the 4-wire terminals of a standard multimeter. Set the multimeter to make a 4-wire ohms measurement with the filter on.
2. Short the four leads together and zero the function on the multimeter.
3. Connect the multimeter to the calibrator as shown in Figure 6-6.

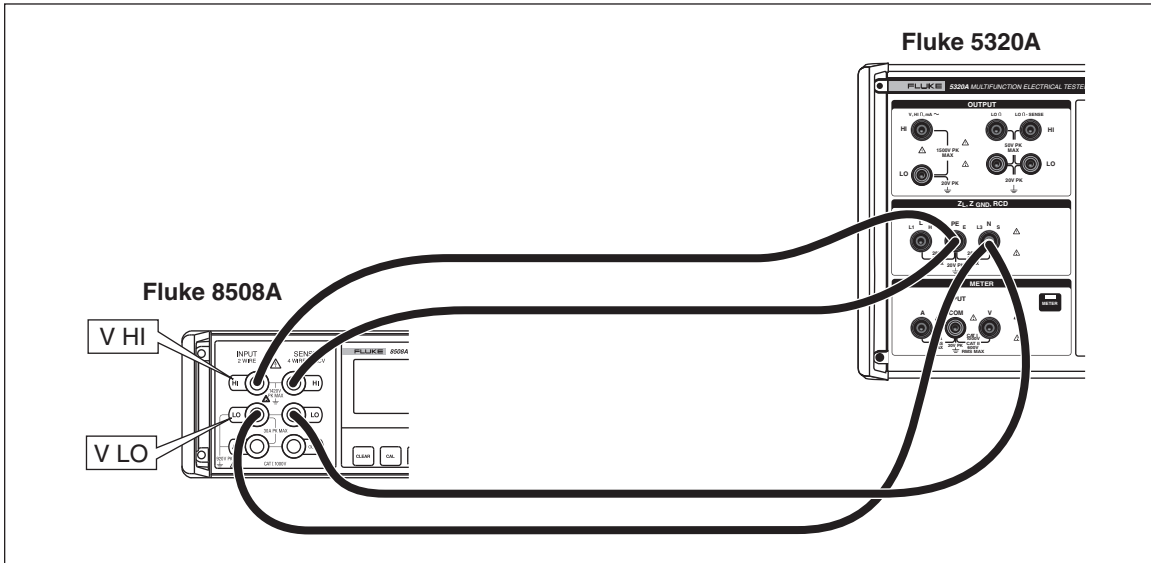

Figure 6-6. High Test Current Verification with Ohmmeter

ehq090.eps

4. Verify the Calibrator’s Ground Bond Resistance calibration performance at each resistance point listed in Table 6-9. Deviations should not exceed the specified limits.

Table 6-9. Ground Bond Source Limits

Nominal Value	Required Standard Ohmmeter Accuracy	Lower Limit ^[1]	Upper Limit ^[1]
5 Ω	±3 mΩ	Rcal - 30 mΩ	Rcal + 30 mΩ
10 Ω	±6 mΩ	Rcal - 60 mΩ	Rcal + 60 mΩ
18 Ω	±10 mΩ	Rcal - 100 mΩ	Rcal + 100 mΩ
50 Ω	±30 mΩ	Rcal - 300 mΩ	Rcal + 300 mΩ
100 Ω	±50 mΩ	Rcal - 500 mΩ	Rcal + 500 mΩ
180 Ω	±100 mΩ	Rcal - 1.0 Ω	Rcal + 1.0 Ω
500 Ω	±250 mΩ	Rcal - 2.5 Ω	Rcal + 2.5 Ω
1 kΩ	±500 mΩ	Rcal - 5.0 Ω	Rcal + 5.0 Ω
1.8 kΩ	±1 Ω	Rcal - 10.0 Ω	Rcal + 10.0 Ω

[1] Maximum deviation from displayed value.

Leakage Current Verification

⚠ ⚠ Warning

To avoid electric shock and possible damage to the Calibrator and other test equipment, ensure all test leads are properly connected and equipment settings are correctly set before activating either calibrator's output with the operate switch.

1. Press **[mA~]** to select the passive leakage current function on the Calibrator. Connect the multifunction calibrator's output (Fluke 5520A in this example) to the HI and LO V~ terminals of the Calibrator as shown in Figure 6-7. On the 5520A calibrator, set its output to the nominal voltage of the power line voltage the Calibrator is powered from (115 V ac or 230 V ac), and set the frequency to 55 Hz.
2. Connect the standard multimeter's current terminals according to the connections shown in Figure 6-7. Select the ACI function with auto range on the standard multimeter (for example, Fluke 8508A).

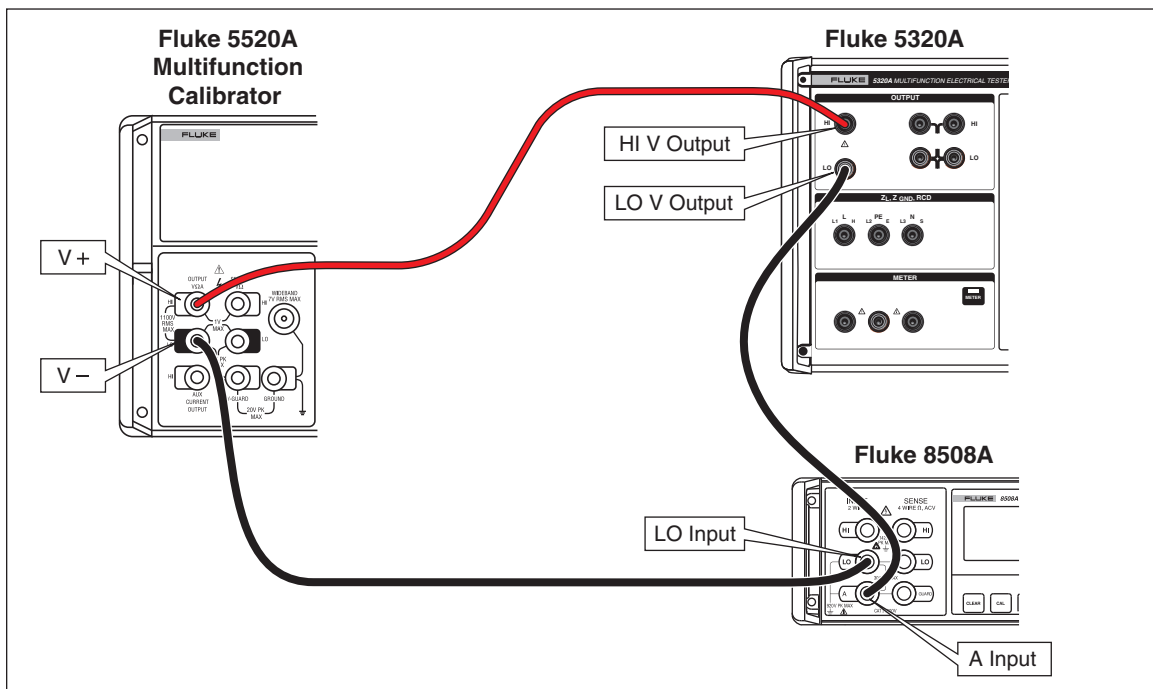

Figure 6-7. Multimeter Current Verification Setup

ehq008.eps

3. Perform an ac current test on ranges 0.3, 3, and 30 mA according to the points listed in Table 6-10. Compare the readings on the standard multimeter with the Calibrator's measured I_d . Deviations should not exceed the specified limits.
4. Set the multifunction calibrator to 40 Volts at 55 Hz in Standby.
5. Set the Calibrator I_d nom for 250 μ A and press **[OPER]**.
6. Set the multimeter to the 1 mA range.
7. Press the OPER key on the multifunction calibrator and adjust the output voltage for a reading of approximately 250 μ A on the standard multimeter. The reading is "Istd." See Table 6-10.
8. Compare the values with those found in Table 6-10.

- Set the multifunction calibrator, the Calibrator, and multimeter ranges for the remaining nominal currents found in Table 6-10.

Table 6-10. Leakage Current Limits

Nominal Current	Required Standard Ammeter Accuracy	Lower Limit (mA) ^[1]	Upper Limit (mA) ^[1]
0.25 mA ac	0.05 %	Istd -2.75 μ A	Istd +2.75 μ A
2.5 mA ac	0.05 %	Istd -9.5 μ A	Istd +9.5 μ A
25 mA ac	0.05 %	Istd -77 μ A	Istd +77 μ A

[1] Maximum deviation from calibration value.

RCD Trip Current Verification

- Connect the Calibrator to the multifunction calibrator as shown in Figure 6-8.

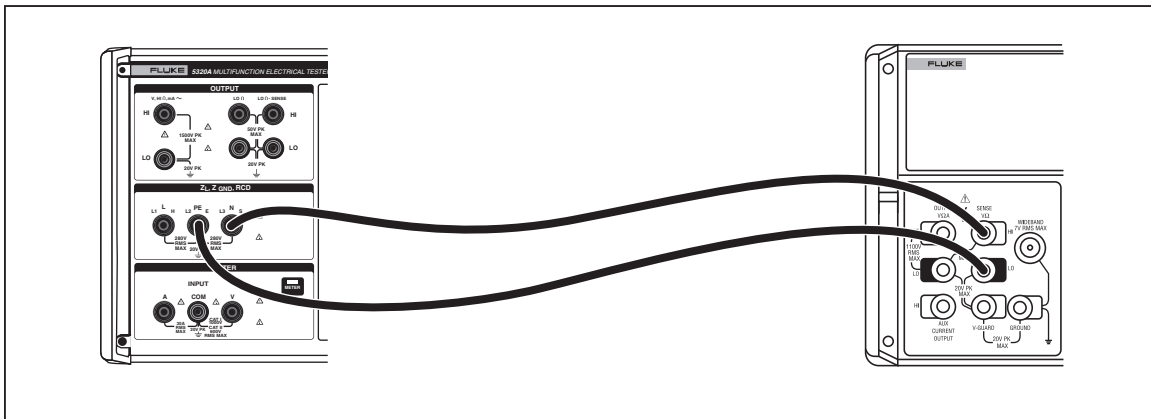

Figure 6-8. RCD Trip Current Calibration Connections

ewt035.eps

- Press **RCD**.
- Set 25 mA range on the Calibrator.
- If RCD Trip Current is not already displayed, press the **Mode** softkey.
- Using the cursor keys or rotary knob, highlight the **Trip Current** selection and either press the **Select** softkey or press in on the rotary knob.
- Set the multifunction calibrator to the start current listed in Table 6-11..
- Press **OPER** on the Calibrator.
- Press **OPR** on the multifunction calibrator.
- Slowly increment the current on the multifunction calibrator until the Calibrator trips to **STBY**.
- Compare the output from the multifunction calibrator with the value listed in Table 6-11. Deviations should not exceed the specified limits.

Table 6-11. RCD Trip Current Limits

Nominal Current	Required Standard Ammeter Accuracy	Frequency	Start Current	Increment by	Lower Limit (mA)	Upper Limit (mA)
25 mA ac	0.2 %	55 Hz	20 μ A	0.1 mA	24.75 ma	25.25 ma
250 mA ac	0.2 %	55 Hz	210 mA	1 mA	247.5 ma	252.5 ma
2500 mA ac	0.2 %	55 Hz	2.1 A	10 mA	2475 ma	2525 ma

RCD Trip Current Meter Verification

This calibration verifies the trip current meter in the RCD function.

1. Connect the Calibrator to the multifunction calibrator as shown in Figure 6-8.
2. Press the softkey labeled **SETUP**.
3. Using the cursor keys or rotary knob, highlight the **Calibration** selection and either press the **Select** softkey or press in on the rotary knob.
4. Enter the password using the keypad (0235 factory default).
5. Using the cursor keys or rotary knob, move the cursor to **RCD Trip Current** and either press the **SELECT** softkey or press in on the rotary knob.
6. Using the cursor keys or rotary knob, move the cursor to **RCD I01 Trip Current 30mAac** and either press the **SELECT** softkey or press in on the rotary knob.
7. Set the multifunction calibrator to 25 mA ac at 55 Hz.
8. Press **OPER** on the Calibrator.
9. Press **OPR** on the multifunction calibrator.
10. The readout at the bottom of the display should indicate a value between 24.75 mA and 25.25 mA.
11. Put the multifunction calibrator in to standby.
12. Press the **Exit** softkey on the Calibrator.
13. Using the cursor keys or rotary knob, move the cursor to **RCD I02 Trip Current 300mAac** and either press the **SELECT** softkey or press in on the rotary knob.
14. Set the multifunction calibrator to 250 mA ac at 55 Hz.
15. Press **OPER** on the Calibrator.
16. Press **OPR** on the multifunction calibrator.
17. The readout at the bottom of the display should indicate a value between 247.5 mA and 252.5 A.
18. Put the multifunction calibrator in to standby.
19. Press the **Exit** softkey on the Calibrator.
20. Using the cursor keys or rotary knob, move the cursor to **RCD I03 Trip Current 3Aac** and either press the **SELECT** softkey or press in on the rotary knob.
21. Set the multifunction calibrator to 2.50 A ac at 55 Hz.
22. Press **OPER** on the Calibrator.
23. Press **OPR** on the multifunction calibrator.

24. The readout at the bottom of the display should indicate a value between 2.475 A and 2.525 A.
25. Put the multifunction calibrator in to standby.
26. Press the **Exit** softkey on the Calibrator.
27. Press the **Exit** softkey four times to exit the calibration menu.

RCD Trip Time Verification

This calibration verifies the trip time in the RCD function. During the procedure, the Calibrator generates passive pulses at a frequency of 1/T with a 1:1 duty cycle. The range is 50 ms to 5 s.

Required instruments: Fluke 5520A Multifunction Calibrator
Fluke PM6690 Frequency Counter/Time/Analyzer

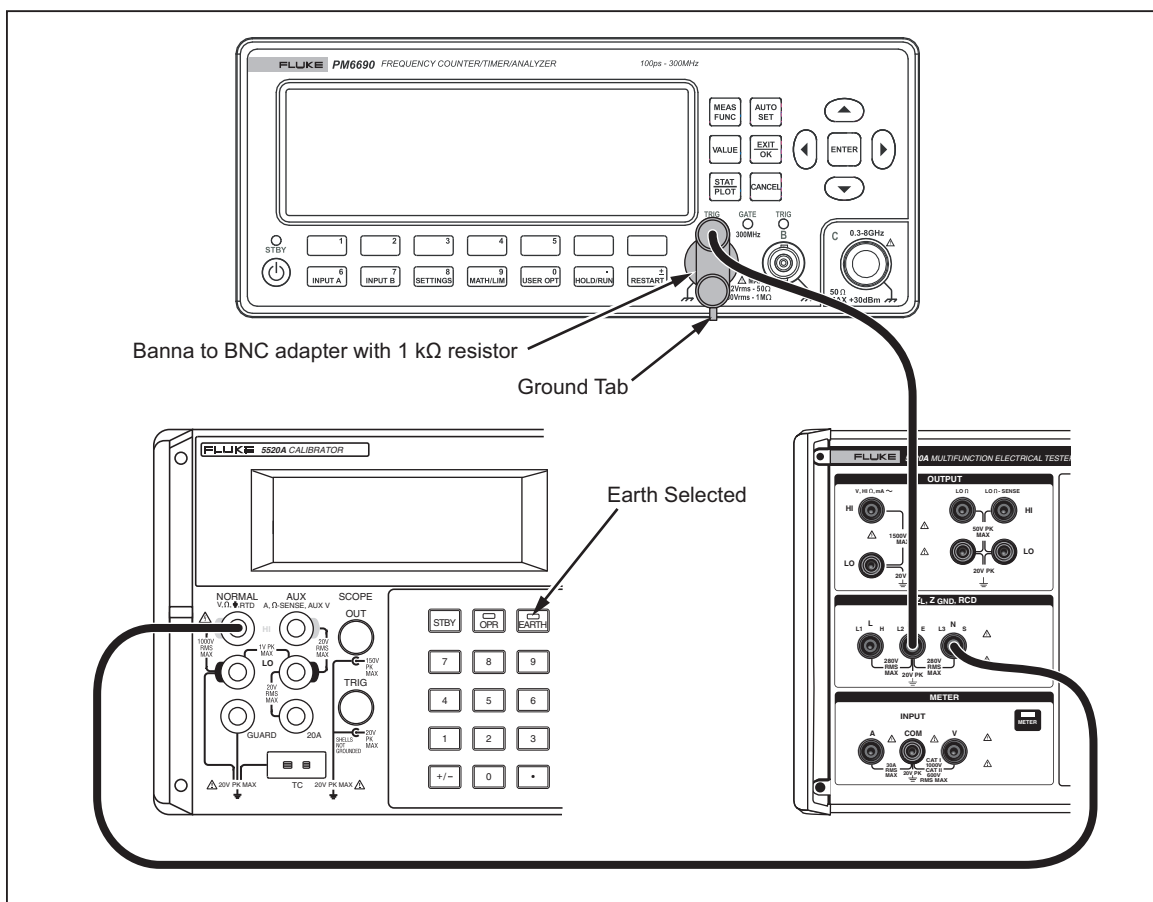

Figure 6-9. Trip Time Verification Connections

ewt034.eps

1. Connect the Calibrator, Fluke 5520A multifunction calibrator and Fluke counter/timer as shown in Figure 6-9.
2. Set 5 Vdc on the multifunction calibrator and turn on the output by pressing **OPR**.
3. Set the pulse width function on the counter, start on rising edge, stop falling edge. Set TRIG to 2.5 V. Set input coupling to dc.
4. Press the softkey labeled **SETUP**.

5. Using the cursor keys or rotary knob, move the cursor to **CALIBRATION** and either press the **SELECT** softkey or press in on the rotary knob.
6. Enter the password using the keypad (0235 factory default).
7. Using the cursor keys or rotary knob, move the cursor to **Trip Time Verification** and either press the **SELECT** softkey or press in on the rotary knob.

Note

If the trip time verification does not appear on the main menu, this revision of IFC and REL boards does not support RCD trip time verification.

8. Set the Calibrator trip time to the value listed under Nominal Trip Time in Table 6-12.
9. The counter should indicate a value between the lower and upper limit in Table 6-12.

Table 6-12. RCD Trip Time Limits

Nominal Trip Time	Required Standard Time Uncertainty	Lower Limit (ms)	Upper Limit (ms)
100 ms	0.05 %	99.75 ms	100.25 ms
1000 ms	0.005 %	999.75 ms	1000.25 ms

AC Voltage Calibrator Verification

Note

This verification procedure can only be performed when the VLC option is installed in the Calibrator.

1. Select the ac voltage calibration function on the Calibrator. Set the output frequency to 55 Hz.
2. Connect a standard multimeter to the appropriate output terminals of the Calibrator and select the ac voltage function. Set the appropriate parameters on the standard multimeter to meet its best accuracy.
3. Verify the Calibrator's ac voltage calibration performance at each voltage point listed in Table 6-13. Deviations should not exceed the specified limits.
4. Set the Calibrator's output voltage to 10 V ac with a frequency of 400 Hz and press **STBY**.
5. Connect a standard counter to the voltage output terminals of the Calibrator.
6. Set the standard counter to measure frequency using auto trigger.
7. Press **OPER** on the Calibrator.
8. Verify the Calibrator's output frequency is within the specifications listed in Table 6-13. Deviations should not exceed specified limits.
9. Press **STBY** on the Calibrator and set the output to 20 V ac at 120 Hz.
10. Connect the Calibrator's output to the distortion analyzer.
11. Set the distortion analyzer to measure distortion with the 30 kHz low pass filter turned on.
12. Compare the distortion analyzer's reading with the value in the distortion section of Table 6-13.

13. Press  on the Calibrator.

Table 6-13. AC Voltage, Frequency Test and Distortion Test Limits

AC Voltage Limits				
Nominal Output Voltage	Required Standard Voltmeter Accuracy	Frequency (Hz)	Lower Limit (V AC)	Upper Limit (V AC)
20 V ac	0.02 %	55	19.971 V	20.029 V
90 V ac	0.02 %	55	89.880 V	90.120 V
250 V ac	0.02 %	55	249.66 V	250.34 V
500 V ac	0.02 %	55	499.32 V	500.68 V
Frequency Test Limits				
Nominal Output Voltage	Required Standard Counter Accuracy	Frequency (Hz)	Lower Limit (Hz)	Upper Limit (Hz)
10 V ac	0.005 %	400 Hz	399.96 Hz	400.04 Hz
Distortion Test Limits				
Nominal Output Voltage	Required Standard Distortion Meter Accuracy	Frequency (Hz)	Limit (%)	
20 V ac	0.005 %	120 Hz	0.25 %	

DC Voltage Calibrator Verification

Note

This verification procedure can only be performed when the VLC option is installed in the Calibrator.

1. Select the dc voltage calibration function on the Calibrator.
2. Connect a standard multimeter to the appropriate output terminals of the Calibrator and select the dc voltage function. Set the appropriate parameters on the standard multimeter to meet its best accuracy.
3. Verify the Calibrator's dc voltage calibration performance at each voltage point listed in Table 6-14. Deviations should not exceed the specified limits.

Table 6-14. DC Voltage Limits

Nominal Output Voltage	Required Standard Voltmeter Accuracy	Lower Limit (V DC)	Upper Limit (V DC)
90 V dc	0.02 %	89.880 V	90.120 V
500 V dc	0.02 %	499.32 V	500.68 V

Meter Verification

1. Select the meter function on the Calibrator. Connect the voltage output terminals of the multifunction calibrator to the Calibrator's Meter V and COM input terminals.
2. Verify the Calibrator's Meter function measures ac and dc voltages within the specifications listed in Table 6-15. Deviations should not exceed specified limits.

3. Select the Meter function on the Calibrator. Connect the current output terminals of the multifunction calibrator to the Calibrator's Meter A and COM terminals.
4. Verify the Calibrator's Meter function measures ac and dc currents within the specifications listed in Table 6-16. Deviations should not exceed specified limits.

At any point in the verification, if a Calibrator function does not fall within the lower and upper limits, the appropriate function and range should be recalibrated. It is not necessary to recalibrate all the functions, just the one that does not meet the specification. Refer to the *5320A Service Manual* or contact Fluke for calibration.

Note

AC voltage frequency and distortion cannot be adjusted in the Calibrator.

Table 6-15. AC/DC Voltage Multimeter Limits

Nominal Output Voltage	Required Standard Voltmeter Accuracy	Frequency (Hz)	Lower Limit (V)	Upper Limit (V)
9 V ac	0.02 %	55	8.9815 V	9.0185 V
90 V ac	0.02 %	55	89.77 V	90.23 V
1000 V ac	0.02 %	55	997.45 V	1002.55 V
9 V dc	0.02 %	-	8.9815 V	9.0185 V
90 V dc	0.02 %	-	89.77 V	90.23 V
1000 V dc	0.02 %	-	997.45 V	1002.55 V

Table 6-16. AC/DC Current Meter Limits

Nominal Output Voltage	Required Standard Voltmeter Accuracy	Frequency (Hz)	Lower Limit (A)	Upper Limit (A)
250 mA ac	0.02 %	55	0.249475 A	0.250525 A
2.5 A ac	0.02 %	55	2.49475 A	2.50525 A
18 A ac	0.02 %	55	17.931 A	18.069 A
250 mA dc	0.02 %	-	0.249475 A	0.250525 A
2.5 A dc	0.02 %	-	2.49475 A	2.50525 A
20 A dc	0.02 %	-	19.925 A	20.075 A

HV Probe Verification

Note

This procedure will use lab test equipment to calibrate the probe to 1 kV dc and 1 kV ac at 50 or 60 Hz. Measurements above 1 kV are considered optional tests. If the HV source does not meet the accuracy requirement, setting the source will require characterizing the source with the voltmeter and precision HV divider.

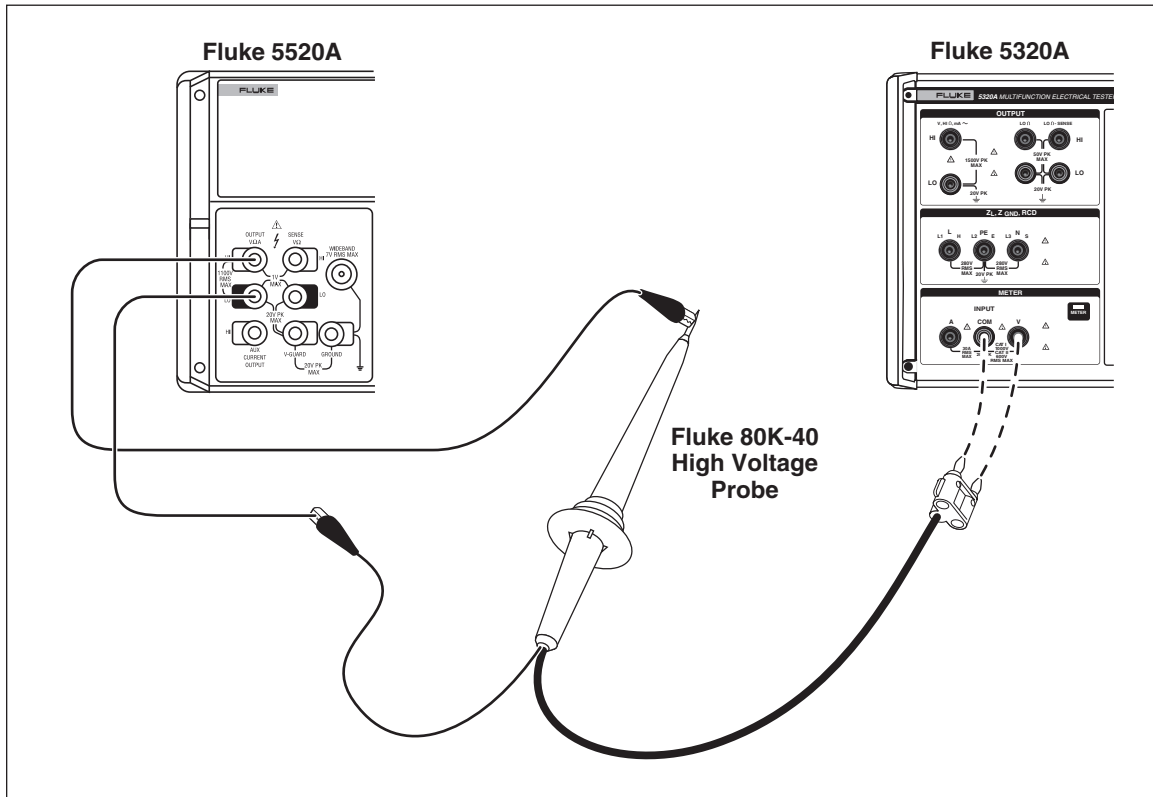

ewt083.eps

Figure 6-10. High Voltage Probe Calibration Connection

1. Connect the multifunction calibrator (5520A in this case) to the High Voltage probe as shown in Figure 6-10.
2. Connect the HV probe output to the V and COM meter inputs of the Calibrator.
3. Select the proper probe (40KV or 10KV) on the Calibrator.
4. Set the multifunction calibrator output to 1000V dc and press the operate key.
5. The Calibrator should read between 992 V and 1008 V (For 40K probe: 985 V and 1015 V).
6. Set the 5520A to standby and 0 V dc.

Note

Steps 7 through 12 are optional verification steps for the 10 kV and 40 kV probes.

7. Connect the HV source to the high voltage divider as shown in Figure 6-11.

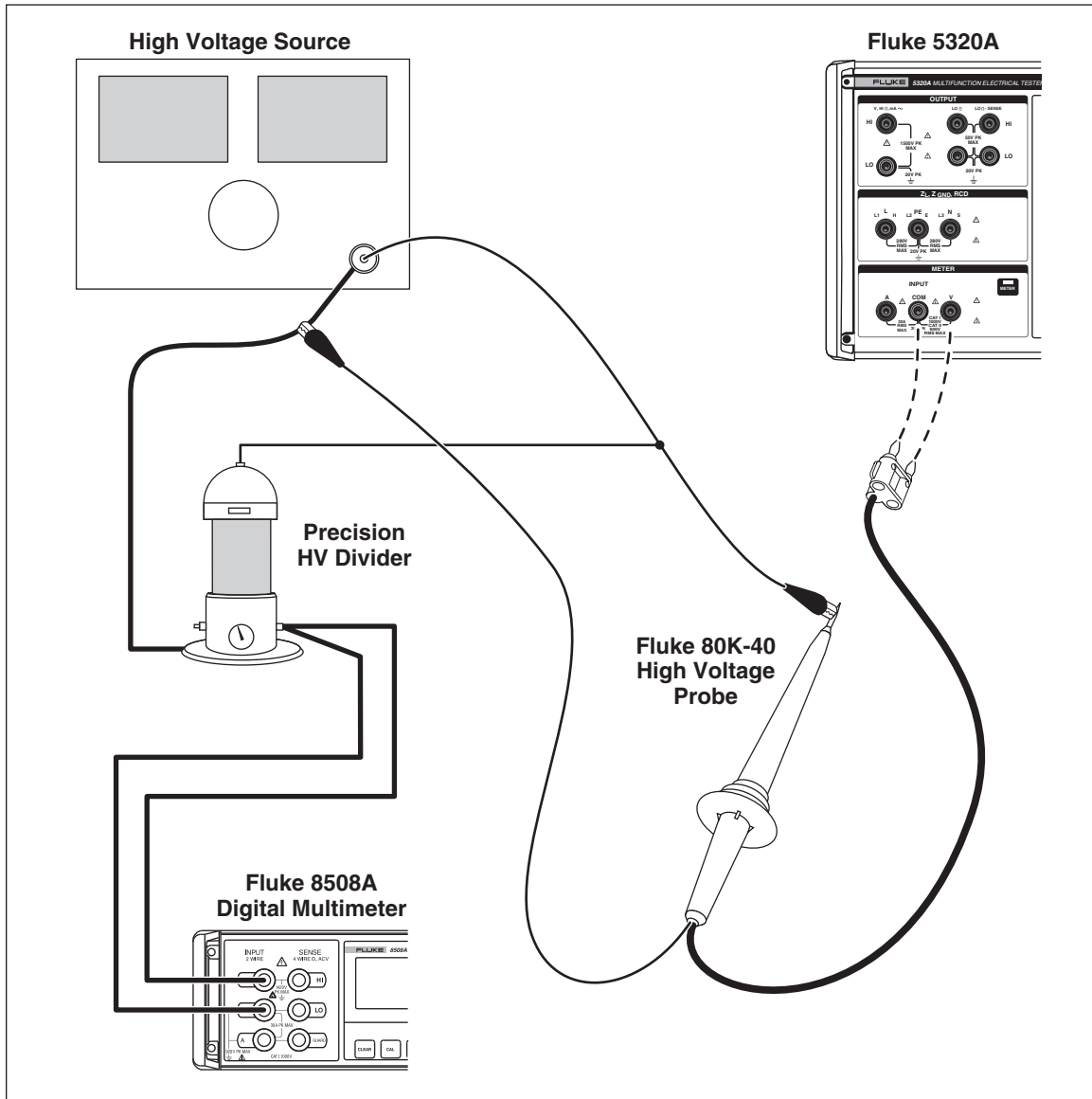

Figure 6-11. High Voltage Divider Calibration Connection

ewt082.eps

8. Set the HV source to 5 kV dc and press the operate key.
9. The Calibrator should read between 4980 V and 5020 V (For 40K probe: 4965 V and 5035 V).
10. Set the HV source to 10 kV dc and press the operate key.
11. The Calibrator should read between 9965 V and 10035 V (For 40K probe: 9940 V and 10060 V).
12. Set the HV source to standby.

Note

Steps 13 through 18 are optional verification steps for the 40 kV probe.

13. Set the HV source to 20 kV 50 or 60 Hz ac and press the operate key.
14. The Calibrator should read between 19890 V and 20110 V.

15. Set the HV source to 30 kV ac and press the operate key.
16. The Calibrator should read between 29840 V and 30160 V.
17. Set the HV source to 40 kV ac and press the operate key.
18. The Calibrator should read between 39790 V and 40210 V.
19. Set the HV source to standby.
20. Remove all connections.

This completes the HV probe verification.

Chapter 7

Applications

Title	Page
Introduction.....	7-3
Calibrating Continuity Testers.....	7-3
Calibrating Earth Resistance Testers.....	7-4
Calibrating Insulation Resistance Testers.....	7-5
Calibrating Insulation Resistance Testers with the Resistance Multiplier.....	7-8
Calibrating Ground Bond Resistance Testers.....	7-10
Calibrating Ground Bond Resistance Testers with the 5320A Transfer Load Adapter.....	7-12
Calibrating Line Impedance Testers.....	7-13
Calibrating Loop Impedance Testers.....	7-15
Calibrating Leakage Current Testers.....	7-16
Passive, Differential and Substitute Leakage Current Calibration.....	7-16
Calibrating Residual Current Device (RCD) Testers.....	7-18
Calibrating RCD Trip Time.....	7-18
Calibrating Using 0.5 I Multiplier.....	7-18
Calibrating Using 1 X I Multiplier.....	7-19
Calibrating using 1.4X I, 2 X I, and 5 X I Multipliers.....	7-20
Calibrating RCD Trip Current.....	7-21
Calibrating AC and DC Voltage (5320A/VLC only).....	7-21
Calibrating Load Test for Appliance Testers.....	7-24
Calibrating High Voltage Sources (Hipots) with a High Voltage Probe.....	7-25
Measuring High Voltage with the High Voltage Adapter.....	7-25
Measuring High Voltage with an 80K-40 High Voltage Probe.....	7-26
Measuring Leakage Current with the 5320A-LOAD.....	7-27

Introduction



This chapter demonstrates the use of the Calibrator with actual calibration examples. For each Calibrator function, calibration steps along with connection figures are provided for at least one UUT.

Calibrating Continuity Testers

Warning

To avoid electric shock, use only high-quality, shrouded test leads and adapters with the appropriate CAT and voltage rating between the Calibrator and instruments being calibrated.

Continuity is a low-ohms test function typically found on most electrical testers, including insulation testers and installation testers. To perform a 2-wire resistance calibration:

1. Press .
2. Using Figure 7-1 for a reference, connect the UUT to the Calibrator's **LOΩ HI** and **LO** terminals.
3. Press the **MODE** softkey. Then, using the cursor keys or rotary knob, highlight **Resistance 2-Wire** and select it by pressing the **Select** softkey or pushing in on the rotary knob.
4. In the Output area of the display, verify **2-Wire** is displayed. If not, press the **MODE** softkey and follow the instructions in step 3 above to select Resistance 2-Wire.
5. Adjust the output value to the desired resistance.
6. Press .

The resistance is applied to the output terminals. Compare the reading on the UUT with the standard value on the Calibrator's display.

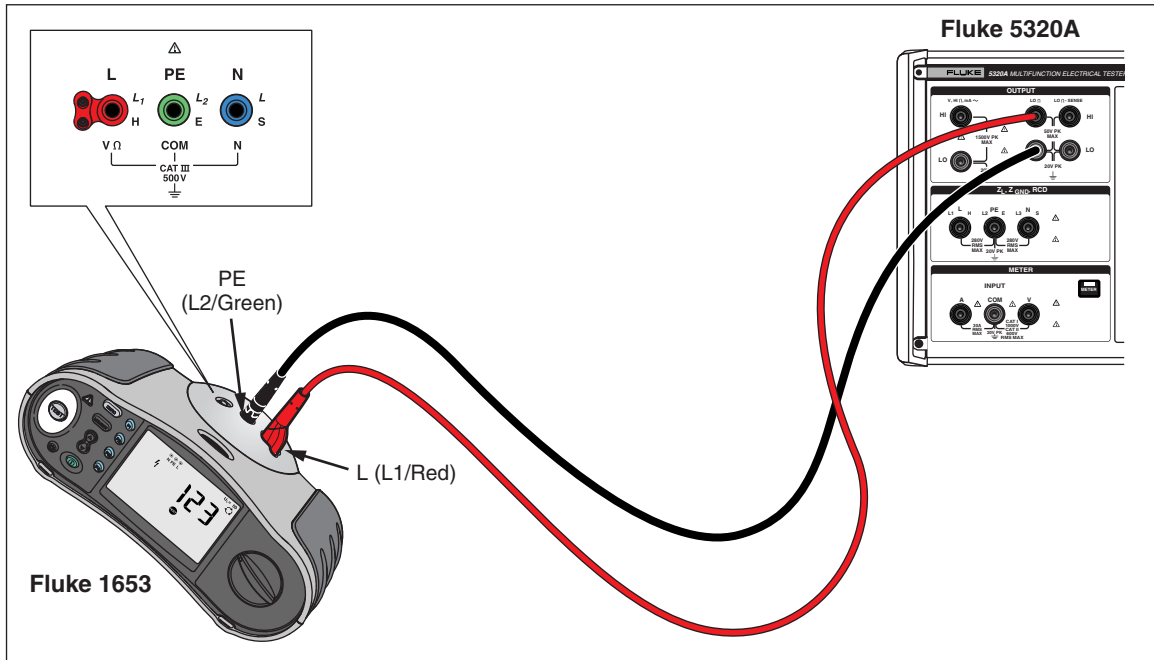

Figure 7-1. Resistance Calibration UUT Connections

ehq030.eps

Calibrating Earth Resistance Testers

Earth Resistance calibration is performed on earth resistance (also referred to as ground resistance) testers and multifunction installation testers with earth resistance testing capability. Most earth testers are 3-pole or 4-pole testers. To calibrate these testers, the low ohms function of the Calibrator must be set to 4-Wire mode. The example below shows how to setup calibration for a 3-pole earth resistance tester.

To perform an Earth Resistance calibration:

1. Press **LOΩ**.
2. Using Figure 7-2 for a reference, connect the UUT to the Calibrator's **LOΩ HI** and **LO** terminals as well as the **LOΩ Sense HI** terminal.
3. Press the **Mode** softkey. Then, using the cursor keys or rotary knob, highlight **Resistance 4-wire** and select it by pressing the **Select** softkey or pushing in on the rotary knob.
4. In the Output display, verify **4-Wire** is displayed. If not, press the **MODE** softkey, and follow the instructions in step 3 above to select Resistance 4-wire.
5. Adjust the output value to the desired resistance.
6. Press **OPER**.

The resistance is applied to the output terminals. Compare the reading on the UUT with the standard value on the Calibrator's display.

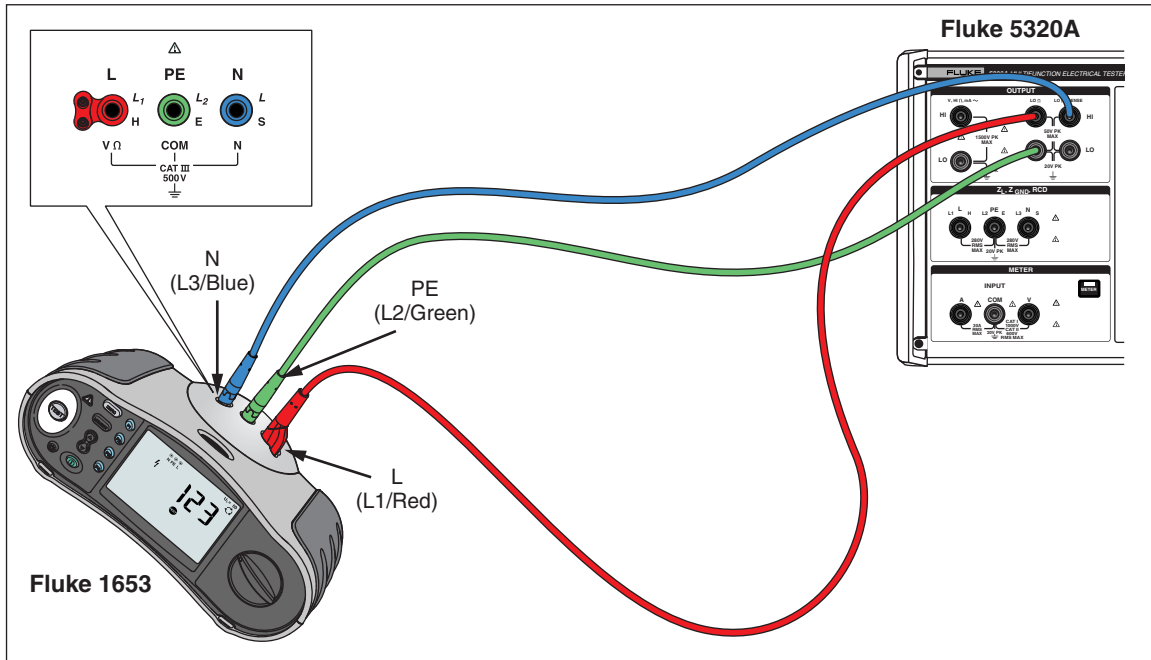

Figure 7-2. Earth Resistance Calibration Connections

Calibrating Insulation Resistance Testers

The Calibrator's high resistance source function is designed for calibrating insulation resistance functions on megohm meters, installation testers, appliance testers and electrical safety analyzers. The high resistance function can also be used for calibrating ohmmeters in a specified resistance range. Figures 7-4 through 7-6 show the connections required for three different UUTs for an insulation resistance calibration procedure.

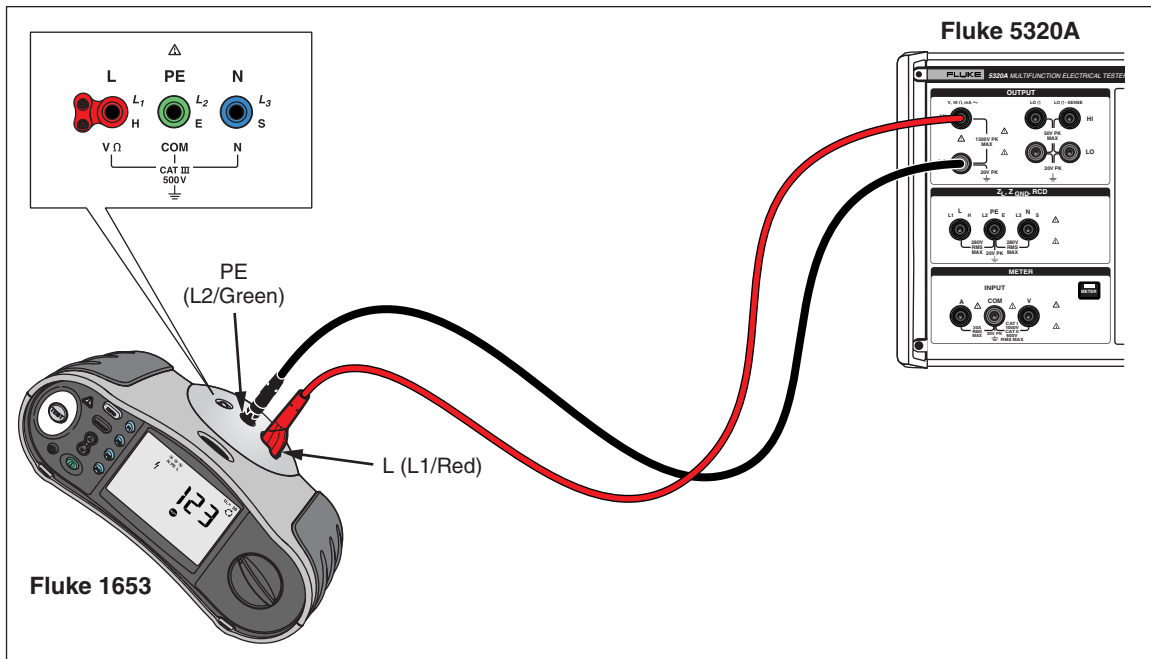

Figure 7-3. Calibrating Insulation Resistance of an Installation Tester

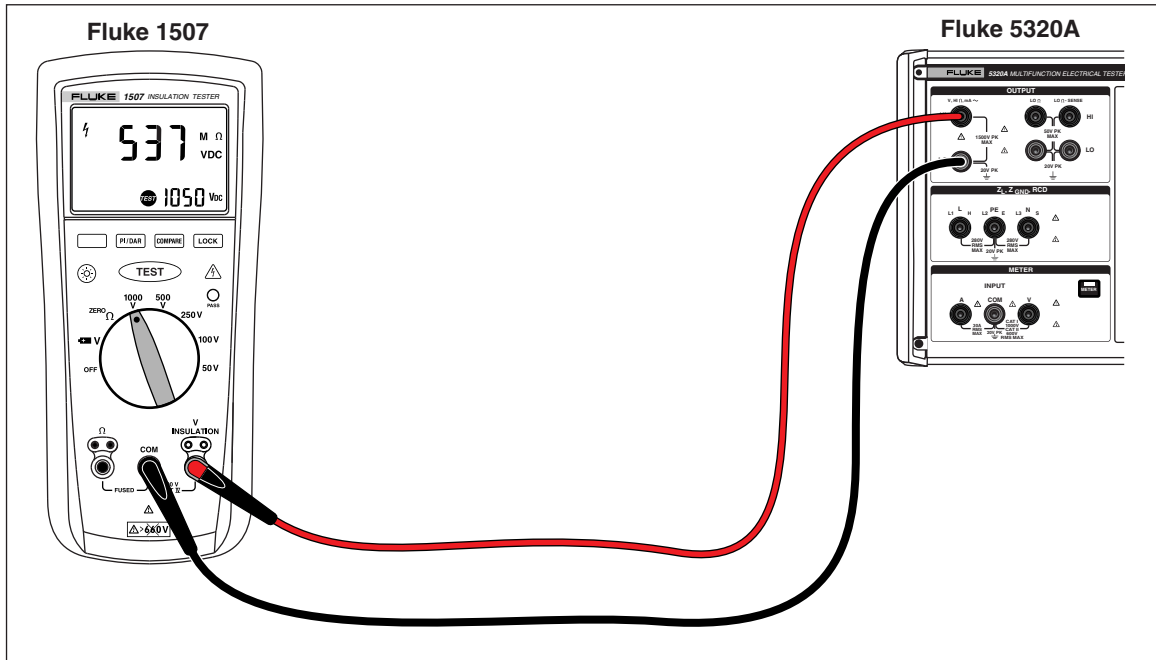

Figure 7-4. Calibrating Insulation Resistance of a Handheld Insulation Tester

ehq047.eps

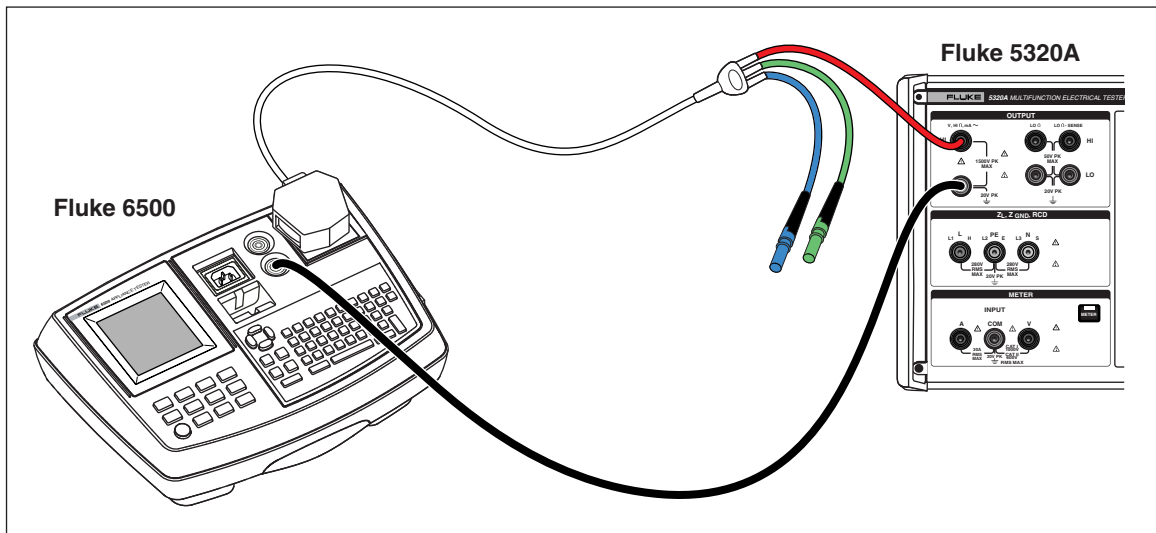

Figure 7-5. Calibrating Insulation Resistance of a Portable Appliance Tester

ehq032.eps

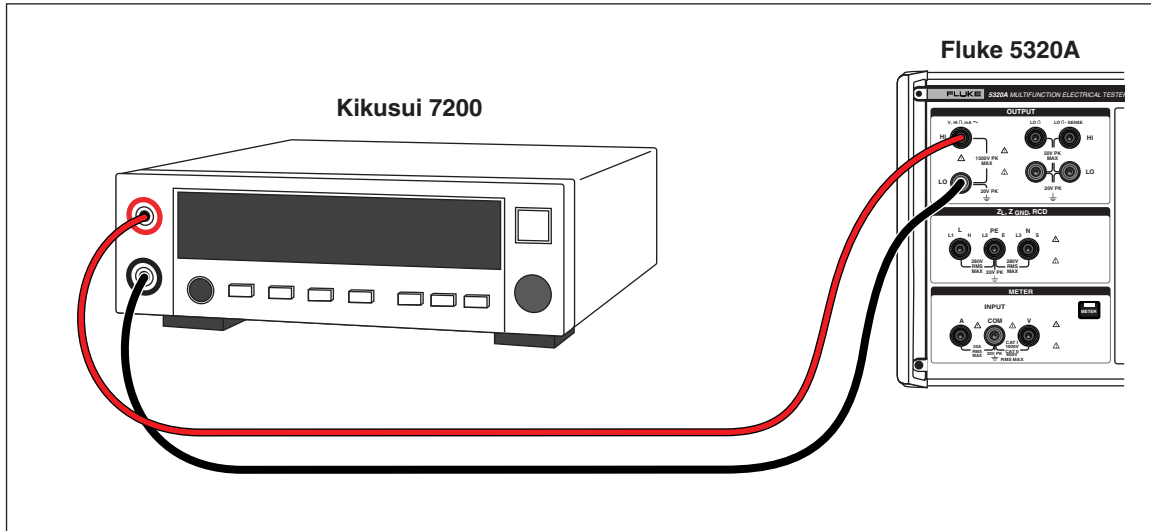

Figure 7-6. Calibrating Insulation Resistance of an Electrical Safety Analyzer

ehq053.eps

To perform an Insulation Resistance calibration:

1. Press **HI Ω**.
2. Using Figures 7-4, 7-5, or 7-6, connect the UUT to the Calibrator's **HI Ω HI** and **LO** output terminals.
3. Press the **Mode** softkey. Then, using the cursor keys or rotary knob, highlight **Resistance** and select it by pressing the **Select** softkey or pushing in on the rotary knob.
4. Adjust the resistance value for the desired resistance.

⚠ Caution

To avoid an overload condition, ensure the UUT test voltage is below the Calibrator's allowed voltage limit before adjusting the resistance value.

5. Set the test voltage on the UUT.
6. Press **OPER**.
7. Activate the measurement on the UUT by pressing its start or test button. The test voltage generated by the UUT is measured by the Calibrator and displayed in the parameters area of the display.
8. Compare the UUT reading with the resistance value in the output area of the display.
9. Stop the test by releasing the appropriate test button on the UUT.
10. Press **STBY** to disconnect the output terminals from the UUT.

Calibrating Insulation Resistance Testers with the Resistance Multiplier

⚠⚠ Warning

To avoid electric shock, connect the Resistance Multiplier Adapter chassis to protective earth ground (PE). The ground terminal on the rear panel of the Calibrator can also be used for this purpose.

The Calibrator's Resistance Multiplier adapter is used to increase the range of high resistance source from 350 M Ω to 10 T Ω , especially when calibrating UUTs with stimulus voltage up to 10 kV. To make an Insulation Resistance calibration with the Resistance Multiplier:

Note

The Resistance Multiplier can only be used with insulation resistance testers that have a third terminal, commonly called the Guard terminal.

1. Press **HI Ω** .
2. Using Figure 7-7 or 7-8, connect the UUT to the resistance multiplier adapter and the Calibrator.
3. Press the **Mode** softkey. Then, using the cursor keys or rotary knob, highlight **Resistance** and select it by pressing the **Select** softkey or pushing in on the rotary knob.

Note

For correct readings, the high resistance source ground must be turned off. Refer to Chapter 4 for changing the ground setting of the high resistance calibration function.

4. If **YES** is not already displayed after **R Multiplier** in the PARAMETERS area of the display, press the **R Mult.** softkey.
5. Adjust the value for desired resistance.
6. Press **OPER**.

⚠ Caution

When using the Resistance Multiplier, the Calibrator cannot monitor the UUT scan test voltage. To avoid possible damage to the adapter and Calibrator, do not exceed maximum peak voltage of 10,000 V on the input terminals of the resistance multiplier.

7. Activate the measurement on the UUT by pressing its start or test button.
8. Compare the UUT reading with the resistance value in the output area of the display.
9. Stop the test by releasing the appropriate test button on the UUT.
10. Press **STBY** to disconnect the output terminals from the UUT.

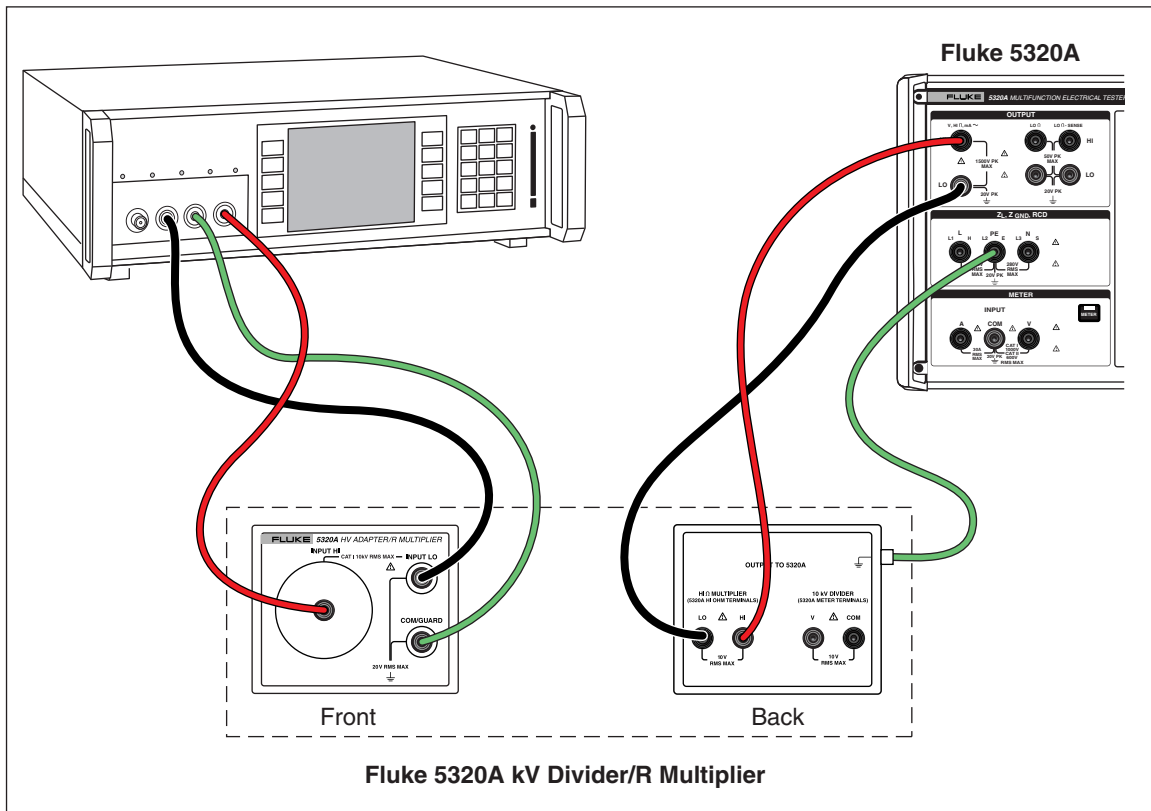

Figure 7-7. Connections to Bench Tester when using Resistance Multiplier Adapter.

ehq051.eps

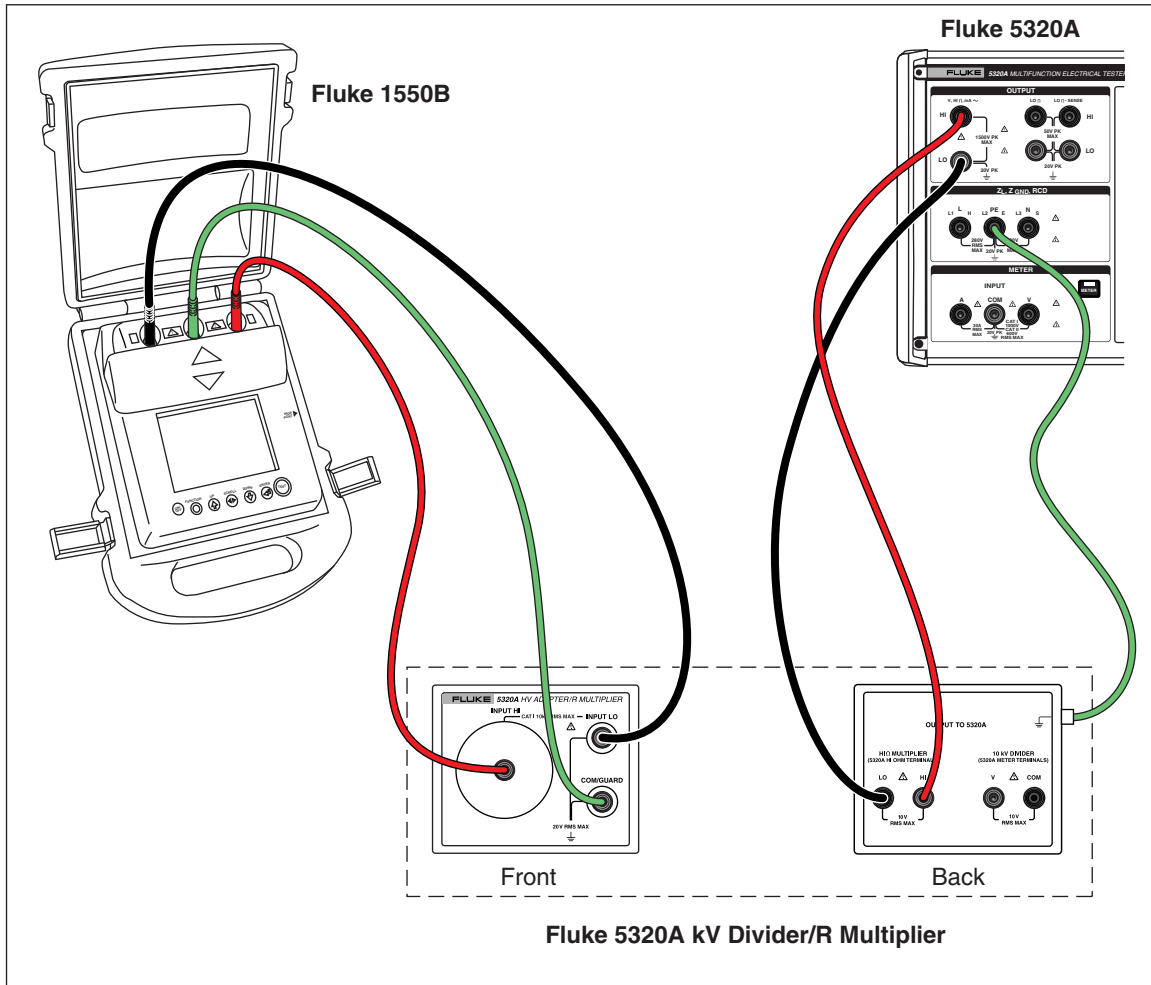

Figure 7-8. Connections to 1550B when using Resistance Multiplier

ehq048.eps

Calibrating Ground Bond Resistance Testers

The Ground Bond Resistance function can be used to calibrate ground bond testers. Some multifunction electrical testers include ground bond testing functionality, including portable appliance testers and electrical safety analyzers.

⚠️ Warning

To avoid electric shock, test wires must NOT be connected to N or L pins of the UUT's appliance socket. These pins have power line voltage applied to them. Also ensure the PE pin does not have dangerous voltage present before making any corrections.

⚠️ Caution

To avoid possible damage to the Calibrator, ensure UUT test current does not exceed maximum allowed current for the test being performed. See Table 4-3 in Chapter 4 of this manual for maximum ratings.

To perform a Ground Bond Resistance calibration:

1. Press **ZGND**.

2. Using Figures 7-9 through 7-11, connect the UUT to the Z_{GND} PE and N terminals of the Calibrator.
3. Press the **MODE** softkey. Then, using the cursor keys or rotary knob, highlight **Resistance** and select it by pressing the **Select** softkey or pushing in on the rotary knob.
4. Select the Ground Bond Resistance function on the UUT.
5. Adjust the resistance value to the desired resistance.

⚠ Caution

Ensure the UUT test current does not exceed the maximum allowed test current displayed in the parameters area of the Calibrator's display. The resistors can handle higher current levels for only short time durations (above the level displayed on the Calibrator). See the specifications section for the maximum short-term allowable current per resistor.

6. Press **OPER**.
7. Press Start on the UUT.

The test current flowing through the UUT and Calibrator is displayed in the PARAMETERS area of the Calibrator's display.

8. Compare the UUT resistance reading with the resistance in the Calibrator's display.
9. Press **STBY** to disconnect the output terminals from the UUT.

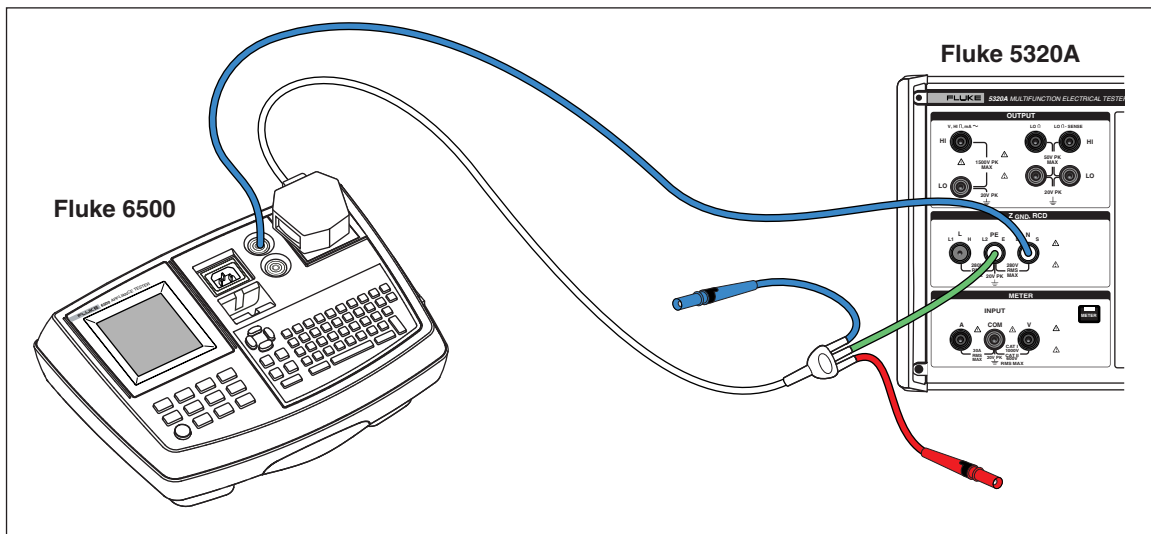

Figure 7-9. Ground Bond Resistance Calibration on Fluke 6500 Using the Cable Adapter

ehq034.eps

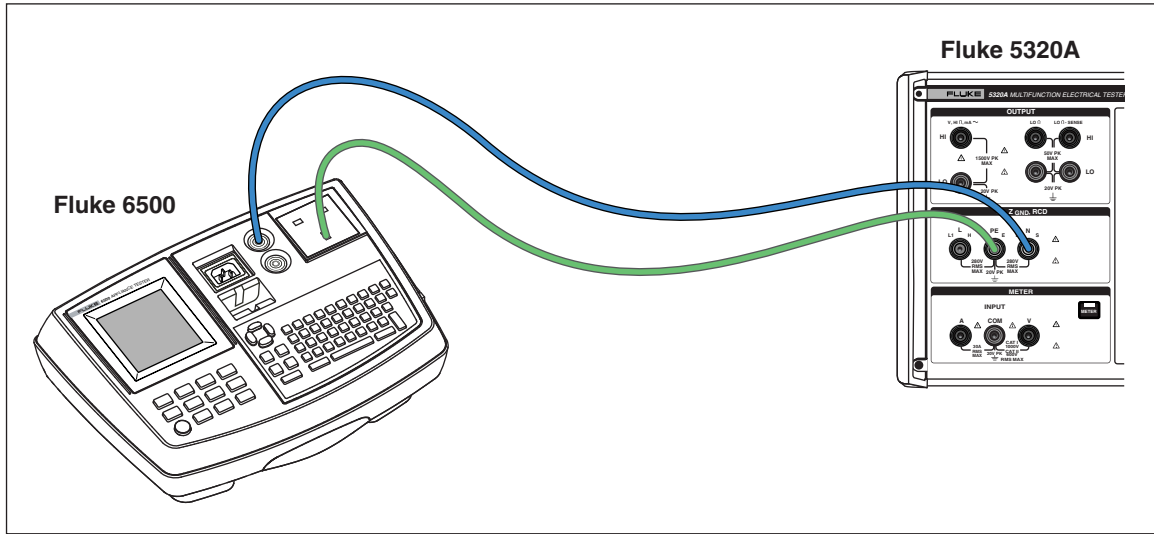

Figure 7-10. Ground Bond Resistance Calibration on Fluke 6500 using Single Test Leads

ehq035.eps

Calibrating Ground Bond Resistance Testers with the 5320A Transfer Load Adapter

The 5320A Transfer Load Adaptor (hereafter called the GBR Adaptor) can be used to calibrate ground bond resistance testers that have higher accuracy requirements than what is provided by a standalone 5320A.

⚠ ⚠ Warning

To avoid electric shock, test wires must NOT be connected to N or L pins of the UUT's appliance socket. These pins have power line voltage applied to them. Also ensure the PE pin does not have dangerous voltage present before making any corrections.

⚠ Caution

To avoid possible damage to the Calibrator, ensure UUT test current does not exceed maximum allowed current for the test being performed. See Table 4-3 in Chapter 4 of this manual for maximum ratings.

To perform a Ground Bond Resistance calibration using the GBR Adaptor:

1. Press **ZGND**.
2. Plug the GBR Adaptor into the Calibrator.
3. Set the UUT to the desired test current, test resistance range, and stimulus type (either AC or DC). If the UUT allows a fixed time interval for the test, use that feature to get the most repeatable results. Set the time to nominally 5 – 10 seconds.
4. Insert short test leads (less than 20 cm) with firm, clean gold-plated contacts into the input of the UUT.
5. Offset or zero the test lead resistance by shorting the test leads coming from the UUT together and enable the zero function on the UUT.

6. As shown in Figures 7-11, connect the UUT to the R0 or R1 – R5 terminal and COM of the GBR Adapter.
7. Press the **MODE** softkey, then using the cursor keys or rotary knob, highlight **Transfer** and select it by pressing the **Select** softkey or pushing in on the rotary knob.
8. Select the Nominal resistance by pushing the **Nom R** softkey until the desired resistance is shown in the Parameters display area.
9. Set the Calibrator to AC or DC depending upon the UUT setting.
10. Press **OPER**.
11. Start the UUT test. The Calibrator INPUT display shows the actual value of the nominal resistance (R0 – R 5) in red while the UUT is measuring. At the end of the test, the INPUT display turns black. Match that reading against the last reading on the UUT.
12. Press **STBY** and disconnect the UUT from the Calibrator.

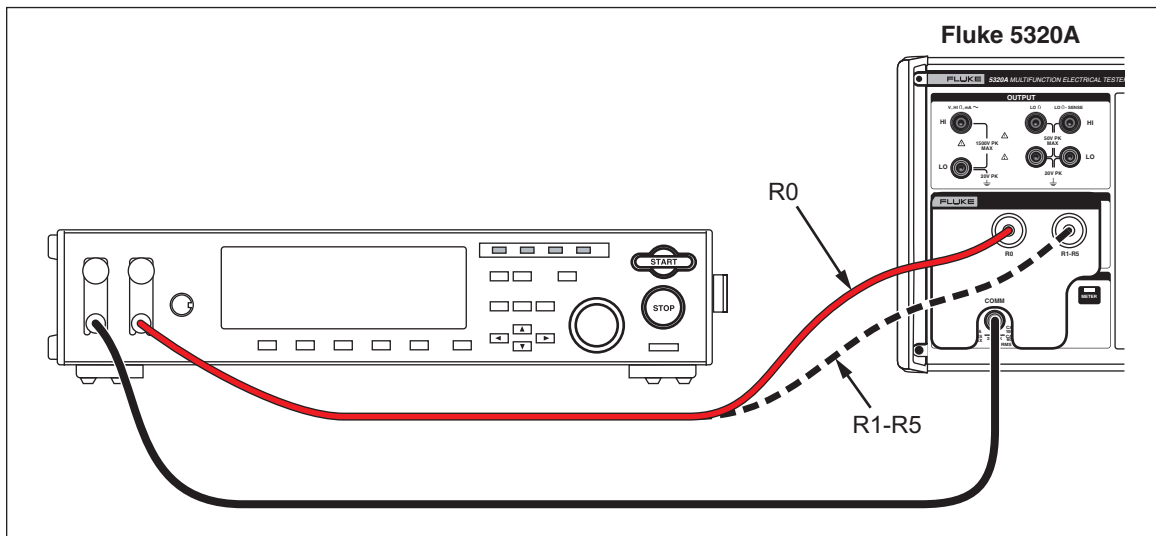

Figure 7-11. Ground Bond Resistance Calibration on Bench Ground Bond Tester

Calibrating Line Impedance Testers

The Calibrator's Line Impedance calibration function calibrates the line impedance function of loop testers and multifunction installation testers. Different models of installation testers use different test current levels to avoid tripping protective circuits. The Calibrator limits the amount of test current that can be used during a line impedance calibration.

⚠ ⚠ Warning

To avoid electric shock, do not touch the L, PE, or N terminals on the Calibrator or UUT while performing a Line Impedance calibration. Line voltage is present on these leads during this calibration.

To perform a Line Impedance calibration:

1. Press **zL**.

2. Using Figure 7-12, connect the UUT to the L, PE and N terminals of the Calibrator. For some line impedance testers, PE does not need to be connected.
3. Press the **Setup** softkey and set the desired residual impedance correction under Line Impedance. See “Selecting the Residual Impedance Correction Mode” in Chapter 4 of this manual for more information on this correction. When set, press the **EXIT** softkey repeatedly to return to the main Line Impedance display.
4. Press the **Mode** softkey. Then, using the cursor keys or rotary knob, highlight **Line** and select it by pressing the **Select** softkey or pushing in on the rotary knob.
5. On the UUT, select the Line Impedance function, test signal, and test condition. Refer to the UUT manual for information on setting these variables.
6. Adjust the Line Impedance to the desired output by using either the rotary knob or \blacktriangle or \blacktriangledown keys.
7. Press **OPER**.
8. Press Start or Test on the UUT.

During the calibration, the PARAMETERS area of the Calibrator’s display indicates the measured test signal polarity, amplitude, and prospective fault current (PFC).

9. When the UUT displays the measured line impedance, compare it to the impedance displayed in the output area of the Calibrator’s display.

Note

When a new impedance is set on the Calibrator, the resistance change takes approximately 500 milliseconds.

10. Press **STBY** to disconnect the output terminals from the UUT.

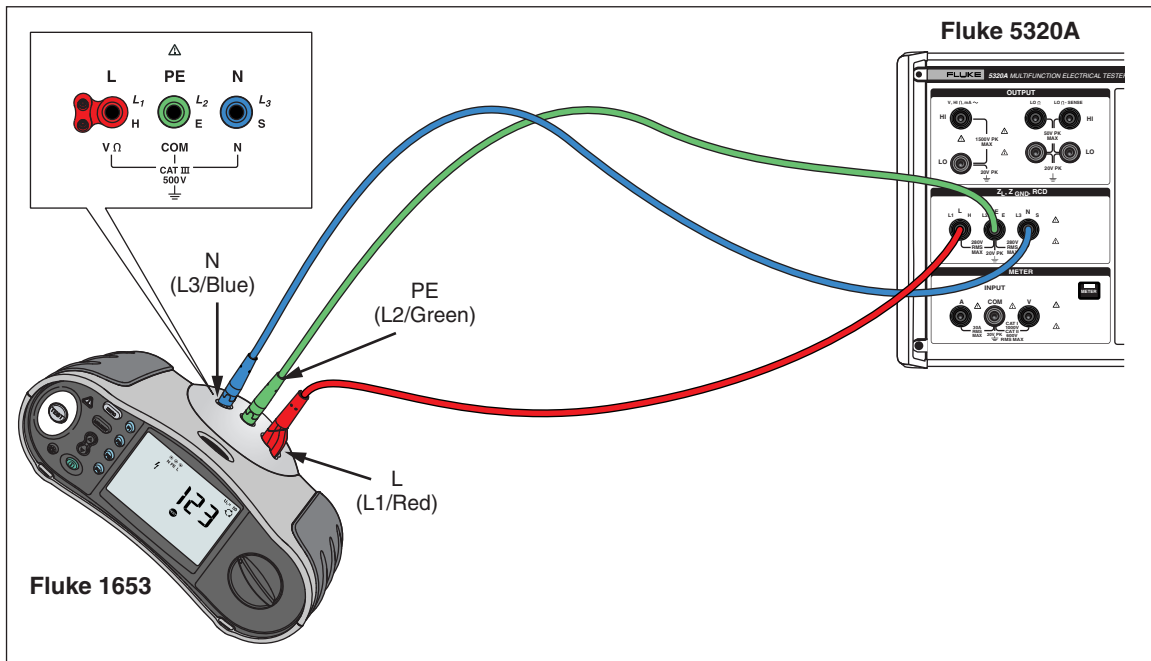

Figure 7-12. Line and Loop Impedance Calibration on a Fluke 1653

ehq037.eps

Calibrating Loop Impedance Testers

The Calibrator's Loop Impedance calibration function is used to calibrate loop testers and multifunction installation testers.

⚠⚠ Warning

To avoid electric shock, do not touch the L, PE, or N terminals on the Calibrator or UUT while performing a Loop Impedance calibration. Line voltage is present on these leads during this calibration.

To perform a Loop Impedance calibration:

1. Press **ZL**.
2. Using Figure 7-12, connect the UUT to the L, PE, and N terminals of the Calibrator.
3. Press the **Setup** softkey and set the desired residual impedance correction under Loop Impedance. See "Selecting the Residual Impedance Correction Mode" in Chapter 4 of this manual for more information on this correction. When set, press the **EXIT** softkey repeatedly to return to the main Line Impedance display.
4. Press the **MODE** softkey. Then, using the cursor keys or rotary knob, highlight **Loop** and select it by pressing the **Select** softkey or pushing in on the rotary knob.
5. On the UUT, select the Loop Impedance function, test signal, and test condition. Refer to the UUT manual for information on setting these variables.
6. Set the Calibrator to the desired Z residual correction setting. Many UUTs can be used with the COMP setting with good results. See Chapter 4 for more information regarding the Z residual correction.
7. Check the serial resistance setting on the Calibrator. Ensure the value is appropriate for this UUT setup. See Chapter 4 for more information on the serial resistance feature.
8. Adjust the Loop Impedance to the desired output by using the rotary knob or **▲** or **▼** keys.
9. Press **OPER**.
10. Press Start on the UUT.
11. When the UUT displays the measured line impedance, compare it to the impedance displayed in the output area of the Calibrator display.

Note

When a new impedance is set on the Calibrator, the resistance change takes approximately 500 milliseconds.

12. Press **STBY** to disconnect the output terminals from the UUT.

Calibrating Leakage Current Testers

The Calibrator's Leakage Current calibration function is used to calibrate the leakage current functions of portable appliance testers and electrical safety analyzers.

⚠ ⚠ Warning

To avoid electric shock, do not touch the Output HI or LO terminals on the Calibrator or UUT while performing a Leakage Current calibration. Line voltage is present on these leads during this calibration.

Passive, Differential and Substitute Leakage Current Calibration

To make a Passive, Differential, or Substitute Leakage current calibration:

1. Press **mA~**.
2. Using Figures 7-13, 7-14 or 7-16, connect the UUT to the Calibrator's Output mA~ HI and LO terminals.
3. Press the **Mode** softkey. Then, using the cursor keys or rotary knob, highlight the desired leakage current (Passive, Differential, or Substitute) and select it by pressing the **Select** softkey or pushing in on the rotary knob.
4. On the UUT, select the desired leakage current function.
5. Press **OPER**.
The Calibrator measures the UUT test voltage. When the UUT voltage settles within the required range, leakage current simulation starts.
6. Compare the leakage current displayed on the UUT with the leakage current in the output area of the Calibrator's display.
7. Press **STBY** to disconnect the output terminals from the UUT.

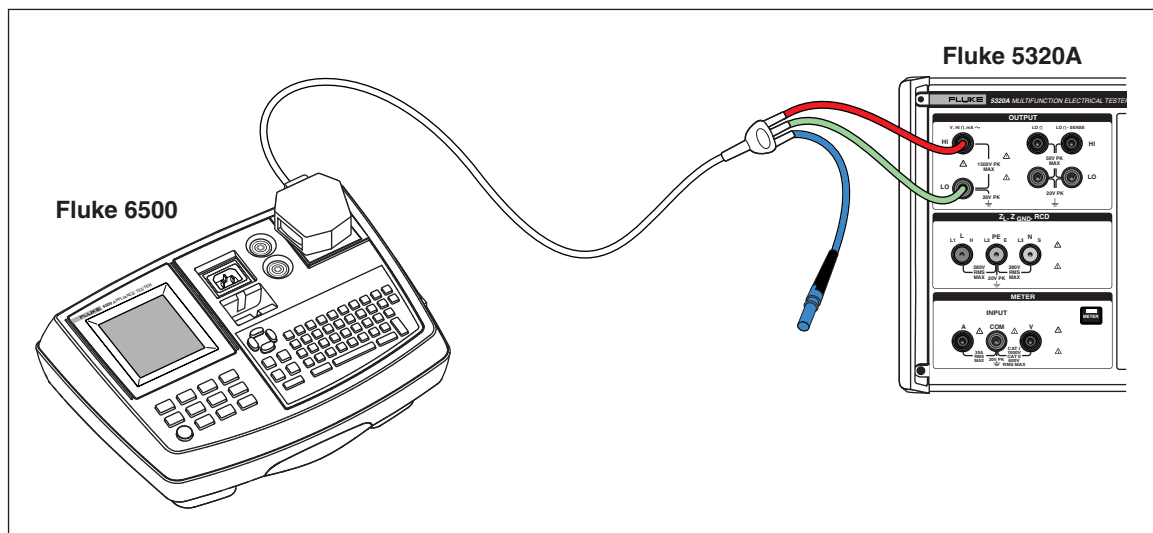

Figure 7-13. Passive Leakage Current Calibration on Fluke 6500

ehq038.eps

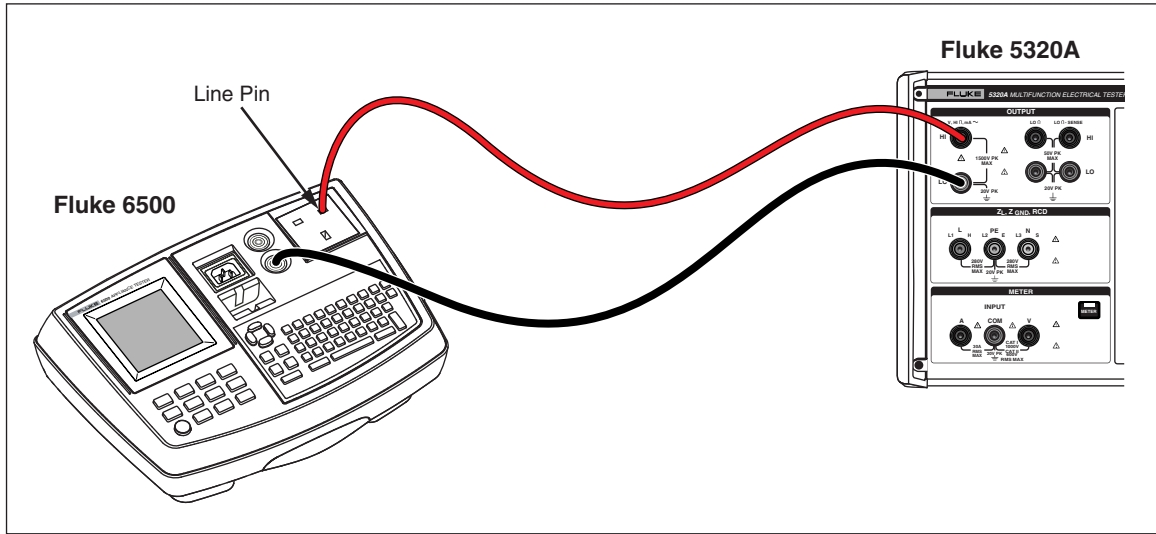

Figure 7-14. Touch Leakage Current Calibration on Fluke 6500

ehq039.eps

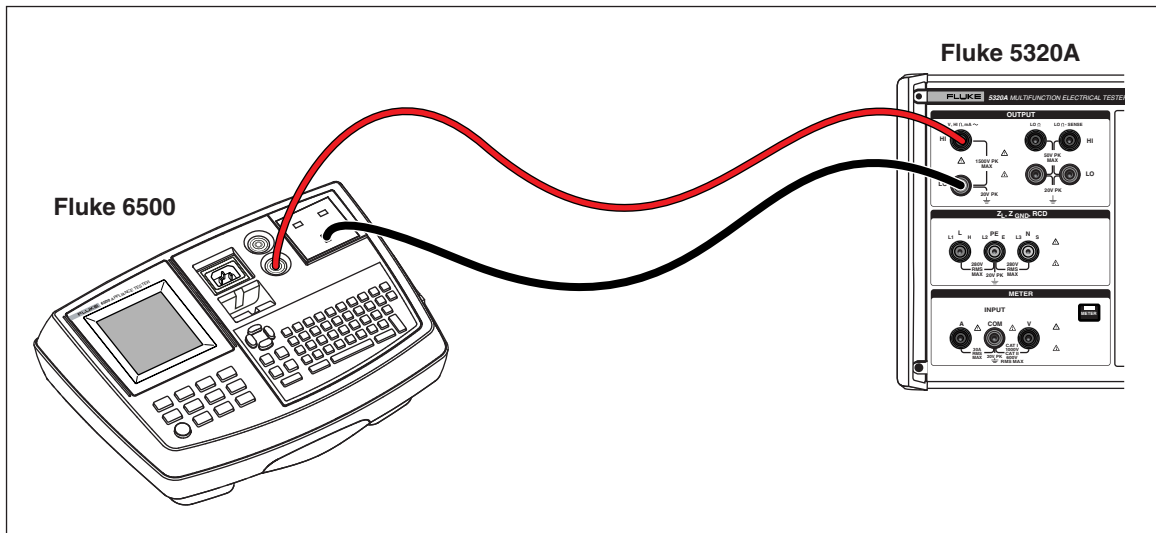

Figure 7-15. Active Leakage Current Calibration on Fluke 6500

ehq056.eps

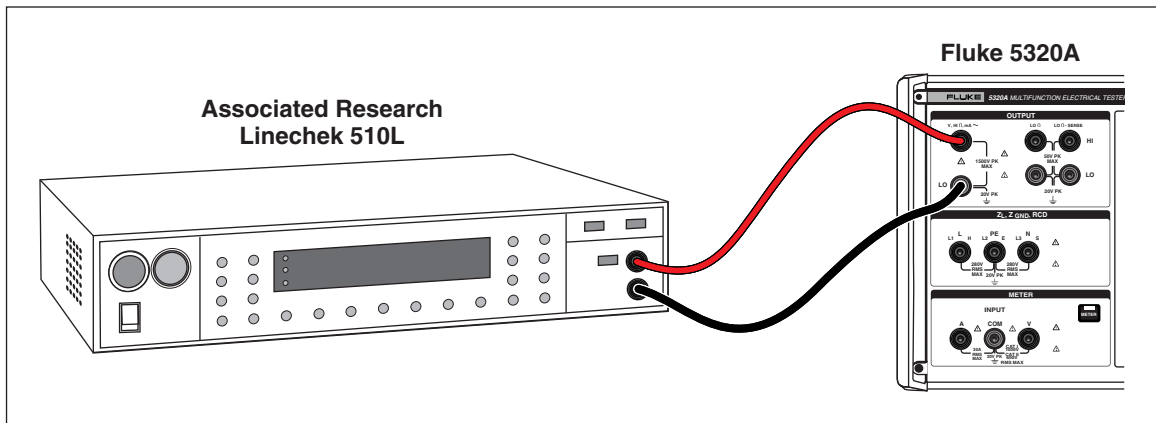

Figure 7-16. Leakage Current Calibration on Earth Leakage Tester

ehq040.eps

Calibrating Residual Current Device (RCD) Testers

The Calibrator has two RCD modes for calibrating trip current and trip time of RCD testers and multifunction installation testers with RCD testing capability.

⚠⚠ Warning

To avoid electric shock, do not touch the L and N terminals while calibrating testers in the RCD function. These terminals have line voltage on them during this calibration process.

Calibrating RCD Trip Time

Trip time RCD calibrations are performed differently depending on the multiplier setting. An example for each variation is listed below.

Calibrating Using 0.5 I Multiplier

The 0.5 I multiplier setting is used to calibrate non-trip RCDs. To perform a calibration for the non-trip RCD function do the following:

1. Press **RCD**.
2. Using Figure 7-17, connect the UUT to the Calibrator's **L**, **PE**, and **N** terminals.
3. Press the **Mode** softkey. Then, using the cursor keys or rotary knob, highlight **Trip Time** and select it by pressing the **Select** softkey or pushing in on the rotary knob.
4. On the UUT, set the following parameters:

I multiplier set to 0.5xI
Nominal trip current (I_{TRIP}) set.
S or G type RCD not set
AC or DC sensitive testing not set
Phase polarity not set
Maximum touch voltage not set

Note

Not all parameters can be accessed on some UUTs, however, nominal trip current must always be set or known.

5. On the Calibrator, make the following settings:

Nominal trip current (I_{TRIP}) set to the same value the RCD is set to.
I multiplier coefficient set to 0.5xI
Series resistance of touch voltage can be set using the Setup and RCD softkeys.
The default series resistance is set to the minimum value.

6. Press **OPER**.

The Calibrator connects the L and N terminals directly to the mains voltage and waits for an external load to be connected by the UUT. If no load is sensed within 10 seconds, the Calibrator will switch to STBY.

7. On the UUT, push Start.

When the Calibrator measures 50% of nominal trip current, the trip time is displayed.

8. Compare the set nominal current value with the measured trip current on the Calibrator.

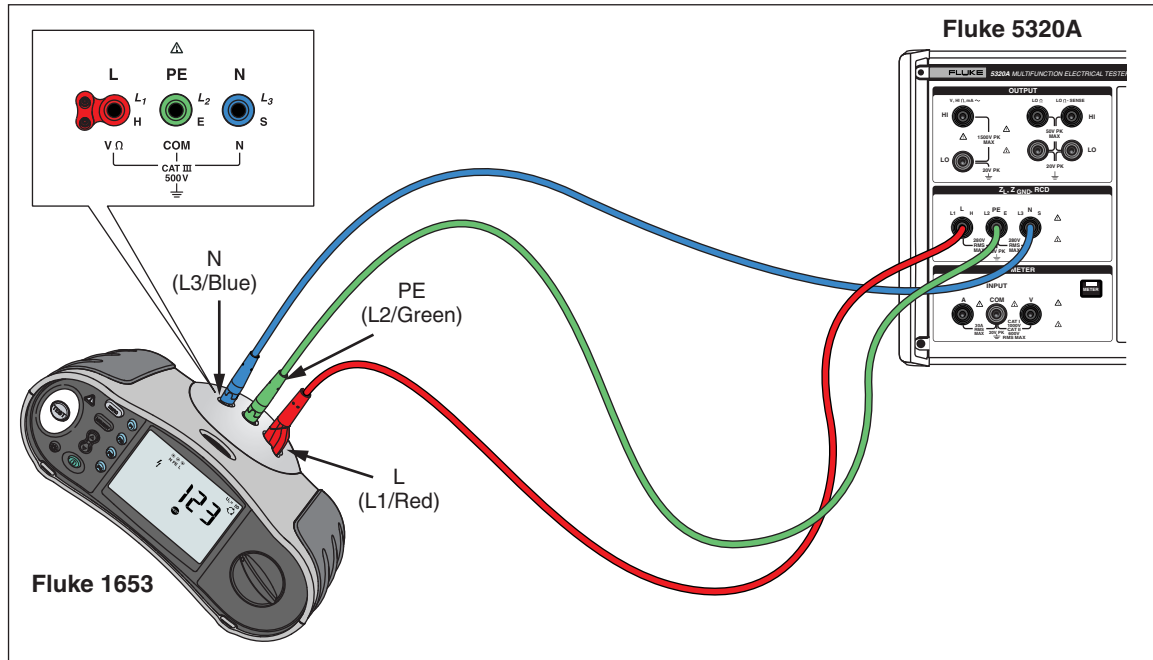

Figure 7-17. RCD Trip Time and Trip Current Calibration

ehq041.eps

Calibrating Using 1 X I Multiplier

In the 1 x I Multiplier mode, the Calibrator acts like a circuit breaker with a set nominal trip current and trip time. To perform a calibration of RCD time:

1. Using Figure 7-17, connect the UUT to the Calibrator's **L**, **PE**, and **N** terminals.
2. Press **RCD**.
3. If **RCD Trip Time** does not already appear in the Output area of the display, press the **Mode** softkey. Then, using the cursor keys or rotary knob, highlight **Trip Time** and select it by pressing the **Select** softkey or pushing in on the rotary knob.
4. On the UUT, set the following parameters:

- I multiplier set to 1xI
- Nominal trip current (I_{TRIP}) set.
- S or G type RCD not set
- AC or DC sensitive testing not set
- Phase polarity not set
- Maximum touch voltage not set

Note

Not all parameters can be accessed on some UUTs. However, nominal trip current must always be set or known.

5. On the Calibrator, make the following settings:

- Nominal trip time in ms
- Nominal trip current (I_{TRIP}) set to the same value the RCD is set to.
- I multiplier coefficient set to 1xI
- I level coefficient. Default set to 90%.
- Series resistance of touch voltage can be set using the Setup and RCD softkeys.
- The default series resistance is set to the minimum value.

6. Press **OPER**.

The Calibrator connects the L and N terminals directly to the mains voltage and waits for an external load to be connected by the UUT. If no load is sensed within 10 seconds, the Calibrator will switch to STBY.

7. On the UUT, push Start.

The Calibrator measures the current, after the nominal trip current is reached, the Calibrator starts a timer, and then disconnects the output terminals when the nominal trip time has elapsed.

8. Compare the nominal trip time on the Calibrator display with the trip time displayed on the UUT.

Calibrating using 1.4X I, 2 X I, and 5 X I Multipliers

The 1.4 X, 2 X, and 5 X multipliers are used to test RCDs under current overloading conditions, with 1.4 times, 2 times or 5 times higher current than the nominal current setting. To perform an RCD trip time calibration with 1.4 X, 2 X, or 5 X multiplier:

1. Press **RCD**.
2. Using Figure 7-17, connect the UUT to the Calibrator's **L**, **PE**, and **N** terminals.
3. Press the **Mode** softkey. Then, using the cursor keys or rotary knob, highlight **Trip Time** and select it by pressing the **Select** softkey or pushing in on the rotary knob.
4. On the UUT, set the following parameters:

I multiplier set to 1.4XI, 2xI, or 5xI
Nominal trip current (I_{TRIP}) set.
S or G type RCD not set
AC or DC sensitive testing not set
Phase polarity not set
Maximum touch voltage not set

Note

Not all parameters can be accessed on the UUT, however, nominal trip current must always be set or known.

5. On the Calibrator, make the following settings:

Nominal trip time in ms
Nominal trip current (I_{TRIP}) set to the same value the RCD is set to.
I multiplier coefficient set to 1.4xI, 2xI, or 5xI, same as that on the UUT.
I level coefficient. Default set to 90%.
Series resistance of touch voltage can be set using the Setup and RCD softkeys.
The default series resistance is set to the minimum value.

6. Press **OPER**.

7. On the UUT, push Start.

The Calibrator measures the current. After the nominal trip current is reached, the Calibrator starts a timer, and then disconnects the output terminals when the nominal trip time has elapsed.

8. Compare the nominal trip time on the Calibrator display with the trip time displayed on the UUT.

Note

When calibrating with a 1.4xI, 2xI, or 5xI setting, the UUT time interval is limited to several hundred milliseconds. If the UUT stops the calibration before the elapsed trip time, the Calibrator disconnects the output terminals from the UUT and displays “Set trip time too high”.

Calibrating RCD Trip Current

The Calibrator uses the same connections for trip current calibration as trip time calibration. To perform an RCD trip current calibration:

1. Press **RCD**.
2. Using Figure 7-17, connect the UUT to the Calibrator’s **L**, **PE**, and **N** terminals.
3. Press the **Mode** softkey. Then, using the cursor keys or rotary knob, highlight **Trip Current** and select it by pressing the **Select** softkey or pushing in on the rotary knob.
4. On the UUT, set the following parameters:

Trip current function selected
Trip current (I_{TRIP}) set
S or G type RCD not set
AC or DC sensitive testing not set
Phase polarity not set
Maximum touch voltage not set

5. On the Calibrator, make the following settings:

Nominal trip current (I_{TRIP}) is set to the same value as the RCD.
Series resistance of touch voltage can be set using the Setup and RCD softkeys.
The default series resistance is set to the minimum value.
6. Press **OPER**.
7. On the UUT, push Start.

The Calibrator measures and then displays the trip current.
8. Compare the nominal trip current with the measured trip current on the Calibrator’s display.

Calibrating AC and DC Voltage (5320A/VLC only)

The Calibrator voltage calibration function is used to calibrate the voltmeter function on portable appliance, insulation, and installation testers.

⚠⚠ Warning

To avoid electric shock, do not touch the terminals or test leads while performing voltage calibrations. Voltages up to 600 V are present on the output HI and LO terminals.

To perform an AC or DC voltage calibration:

1. Using Figures 7-18, 7-19, or 7-20, connect the UUT to the Calibrator’s Output **V HI** and **LO** terminals.
2. Press **V**.

3. Press the **AC/DC** softkey to select either ac or dc.
4. Set the UUT to measure voltage.
5. Set the voltage on the Calibrator to the desired value.
6. Set the output grounding to the desired setting through the Setup and Calibrator softkeys.
7. Press **OPER**.

The Calibrator outputs the set voltage and measures the current flowing between the Calibrator and UUT. If the Calibrator exceeds its maximum current rating, an error message displays and then disconnects the output terminals from the UUT.

8. If necessary, adjust the voltage setting on the Calibrator to get the desired reading on the UUT.

Note

The settling time after making a voltage change while in operate mode depends on the voltage and frequency setting. Under worst conditions, the maximum settling time is approximately 3 seconds.

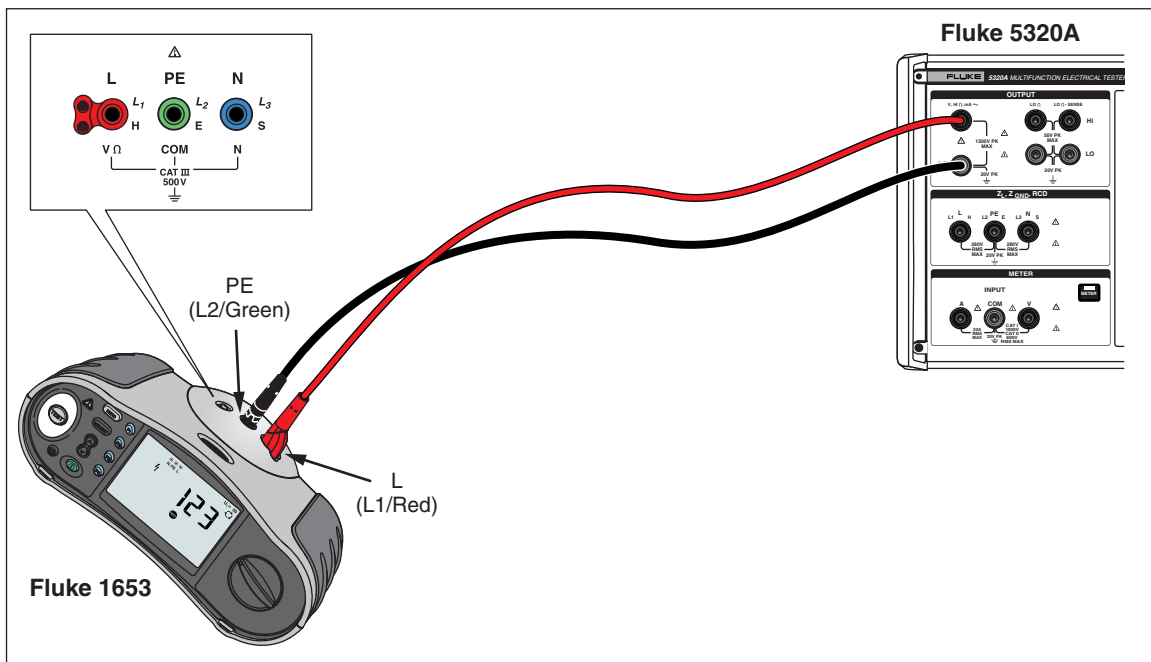

Figure 7-18. Voltage Calibration on Battery-Powered Installation Testers

ehq042.eps

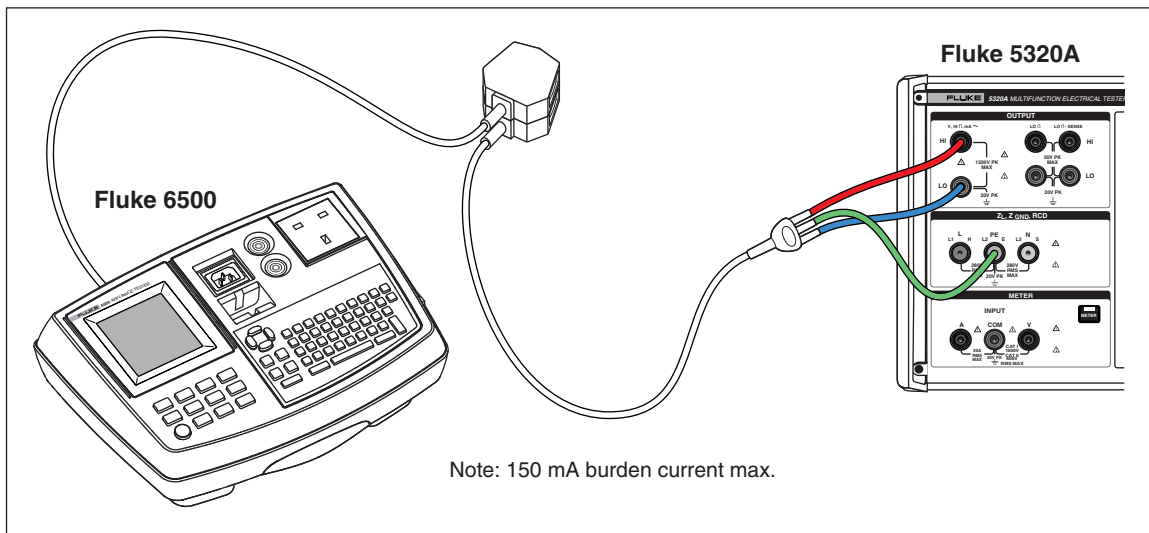

Figure 7-19. Voltage Calibration on Line Powered Appliance Testers

ehq043.eps

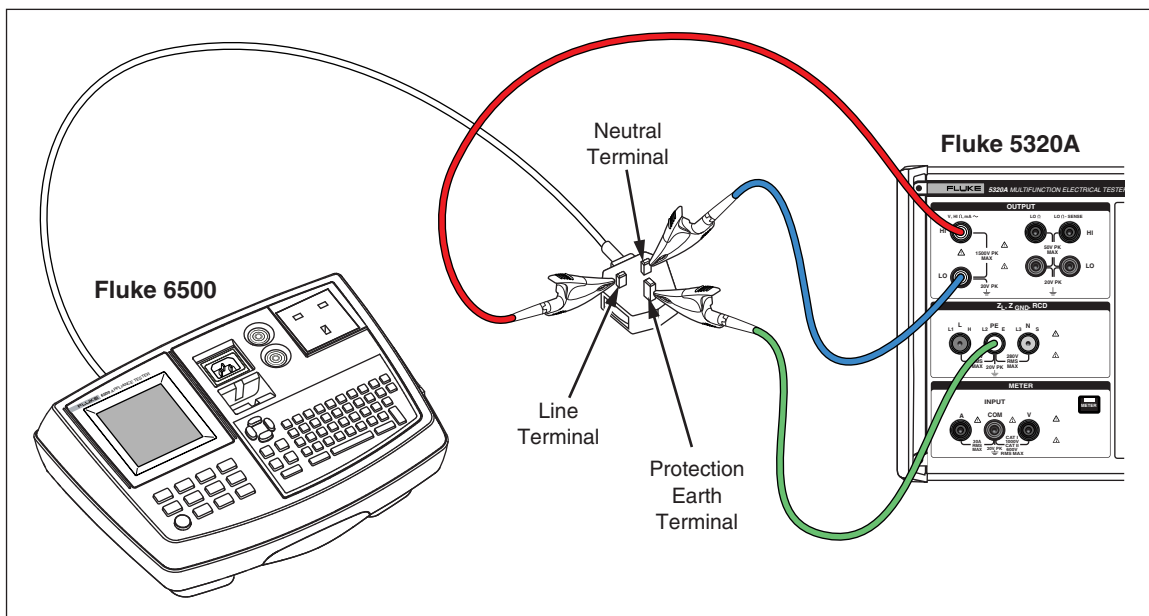

Figure 7-20. Voltage Calibration using Single Wires

ehq044.eps

⚠ ⚠ Warning

When appropriate cable adapters are not available and single test leads are used for voltage calibration, hazardous voltages exist on the test leads. To avoid possible electric shock, test leads should not be touched while the Calibrator is in the Operate mode.

Calibrating Load Test for Appliance Testers

The Calibrator's Meter function is used to calibrate an appliance tester's voltage and current meters. To perform a load test calibration:

1. Press **METER**.
2. Using Figures 7-19, connect the UUT to the Calibrator's Meter A, COM and V terminals. Also, make a protected earth (ground) connection between the UUT and the Calibrator's PE terminal.
3. Set ground mode to OFF through the **Setup** softkey.
4. On the UUT, press Start.

The UUT connects power line voltage to its test socket. The UUT and Calibrator measure power line consumption and load current.

5. Compare the UUT reading with the Calibrator reading.

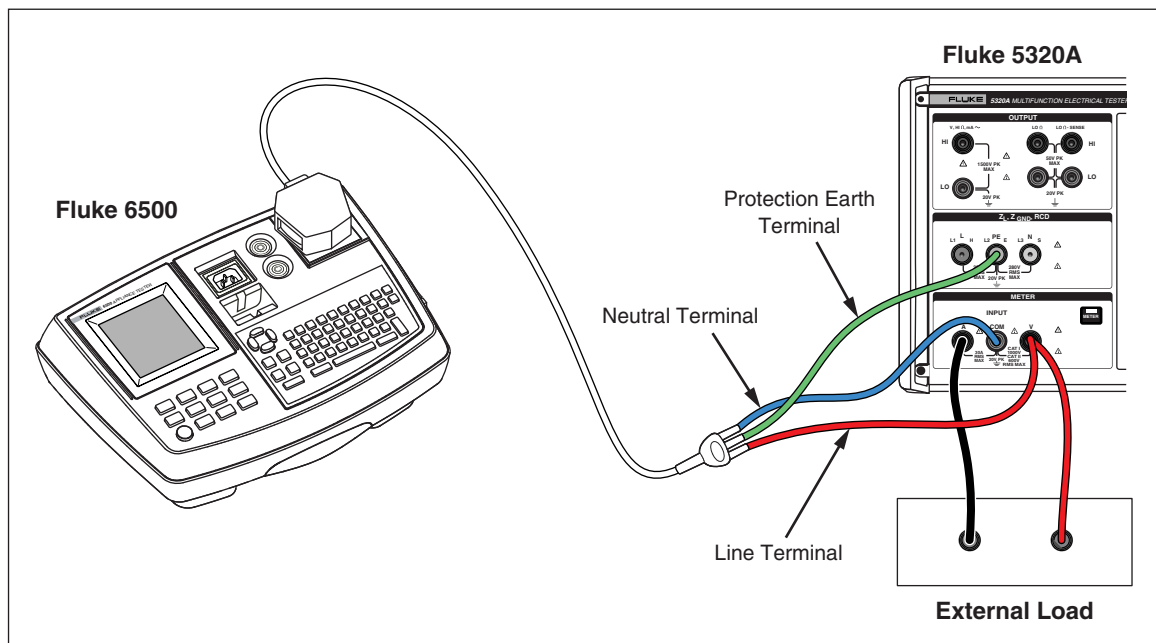

ehq058.eps

Figure 7-21. Voltage and Current Meter Calibration using a Cable Adapter.

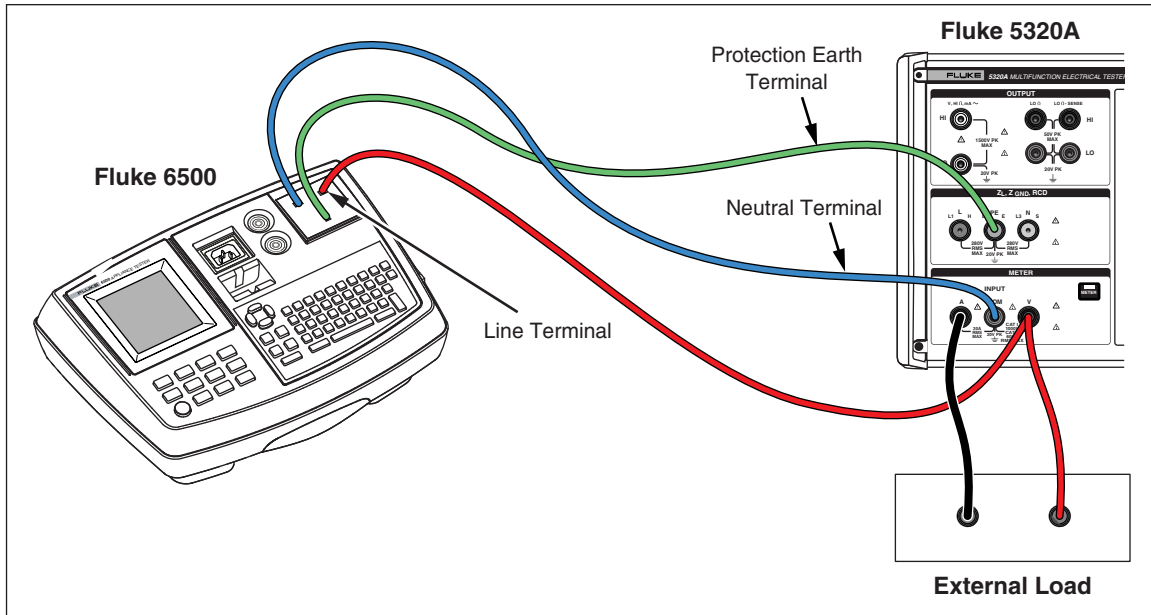

Figure 7-22. Voltage and Current Meter Calibration using single wires

ehq057.eps

Calibrating High Voltage Sources (Hipots) with a High Voltage Probe

The Calibrator can measure voltages above 1,100 volts by using a high voltage adapter or high voltage probe.

Measuring High Voltage with the High Voltage Adapter

The 10 kV High Voltage adapter is a voltage divider that steps the voltage down by a 1:1000 ratio. When purchased with the Calibrator, the High Voltage probe and Calibrator are calibrated together to give better accuracy. To measure a voltage with the High Voltage Probe:

1. Press **METER**.
2. Using Figure 7-23, connect the UUT through the High Voltage adapter and the Calibrator.
3. Press the **Probe** softkey repeatedly until **Probe 10 kV** is selected in the Parameters area of the display.

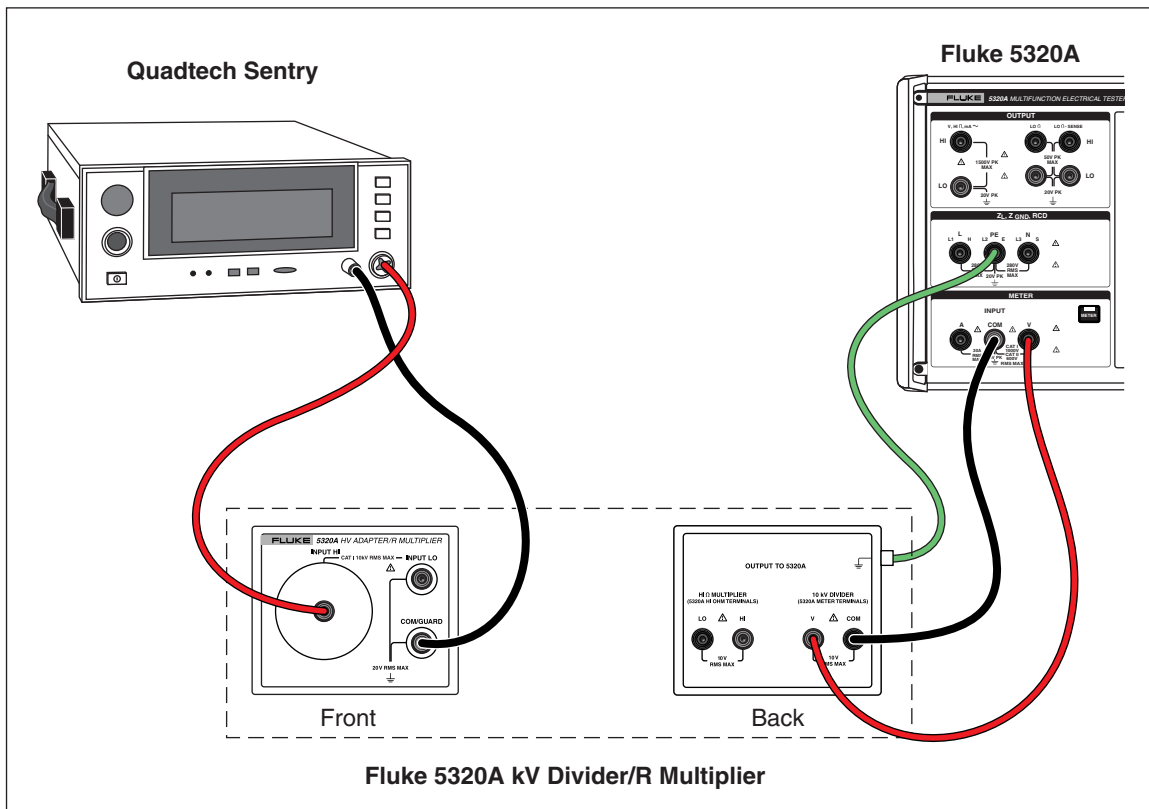

Figure 7-23.10 kV High Voltage Adapter Application

ehq046.eps

Measuring High Voltage with an 80K-40 High Voltage Probe

The Fluke 80K-40 High Voltage probe is a divider that steps down the measured voltage by 1000. To make a high voltage measurement with the 80K-40:

1. Press **METER**.
2. Using Figure 7-24, connect the UUT through the High Voltage probe and the Calibrator. Make sure to connect the ground side of the dual banana lead from the 80k-40 probe to the COM terminal of the 5320A meter.
3. Press the **Probe** softkey repeatedly until **40 kV** is selected in the Parameters area of the display.

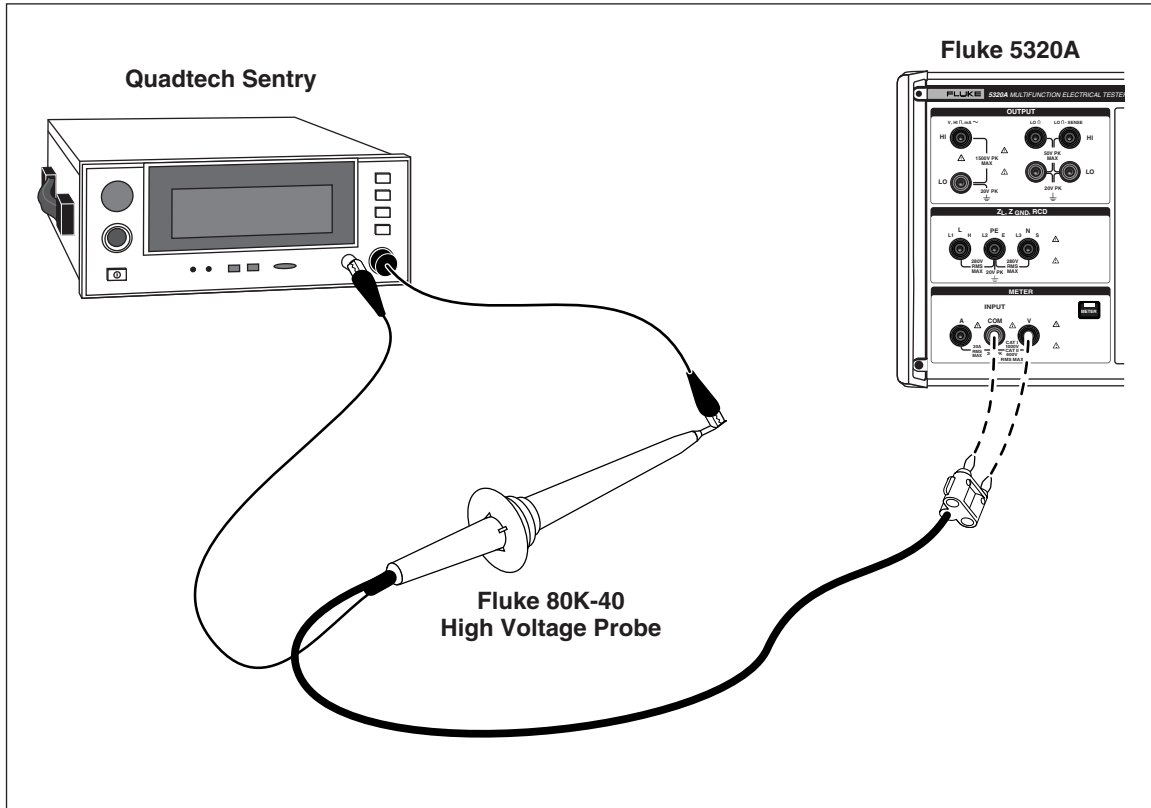

Figure 7-24. 40 kV High Voltage Probe Application

ehq054.eps

⚠ ⚠ Warning

When appropriate cable adapters are not available and single test leads are used for voltage calibration, hazardous voltages exist on the test leads. To avoid possible electric shock, test leads should not be touched while the Calibrator is in the Operate mode.

Measuring Leakage Current with the 5320A-LOAD

The 5320A-LOAD High Voltage Load Adapter (hereafter the Load) creates leakage current while performing hipot tester calibration with the Calibrator. As shown in Figure 7-25, this Adapter consists of a series of eight power-rated resistors configured to provide eight resistance taps from 10 kΩ to 5 MΩ. The maximum withstand voltage is 5.5 kV.

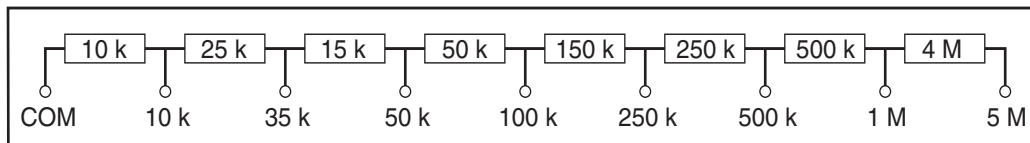

Figure 7-25. Load Schematic

ehq069.eps

⚠ ⚠ Warning

To avoid possible electric shock or personal injury, use this Load only as specified in this instruction sheet with the Calibrator or the protection provided by the Load might be impaired.

Using Figure 7-26 as a reference, connect the hipot tester (UUT) to the Calibrator and the Load. The Load will create the leakage current that will be measured by the Calibrator. The resistance selection on the Load should be chosen for the appropriate leakage current based on voltage amplitude used for the test.

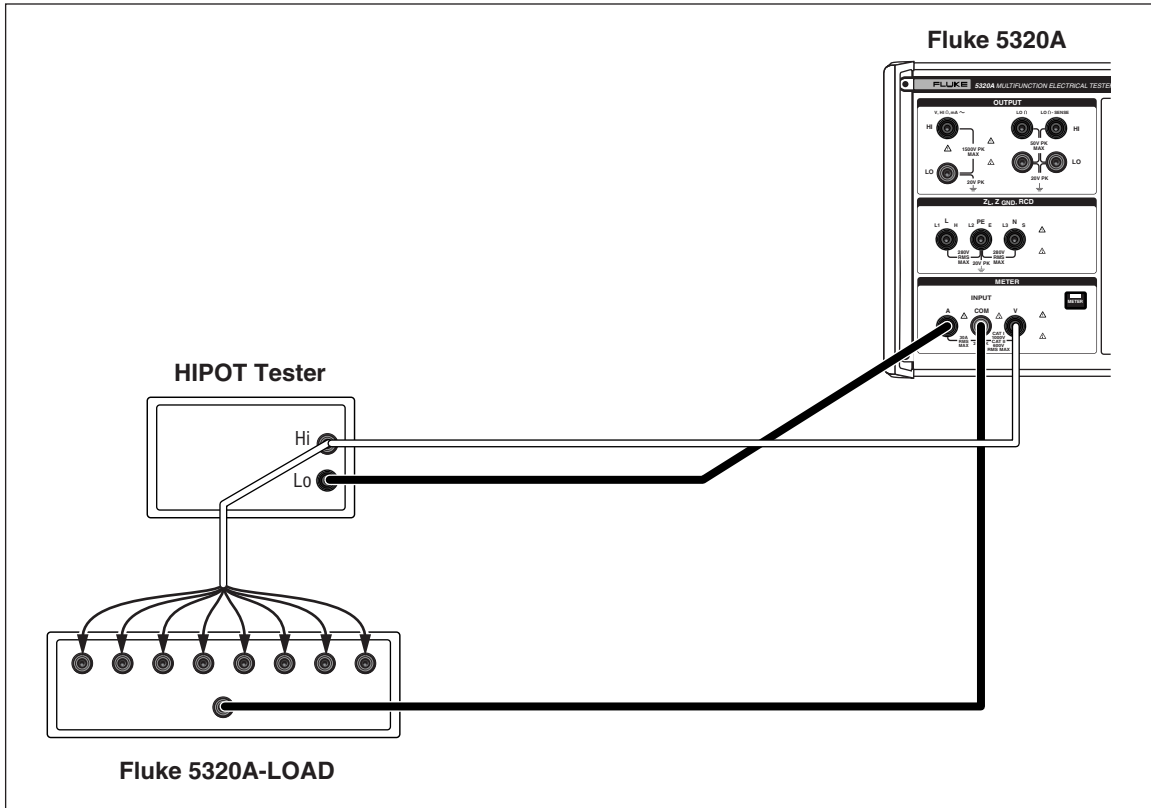

Figure 7-26. Normal Hipot Calibration Connections

ehq062.eps

Note

Before using the Load, read the operating specifications to understand the operating limits.

⚠ Caution

To avoid damage to the Load, never exceed the maximum rated voltage, power, and current limit of the Load.

To set up for a hipot leakage current calibration with less than 1000 V test voltage:

1. Press **METER**.
2. In the meter function, set the Calibrator to HIPOT LC mode. See Figure 7-27 for an example of the leakage current mode display.

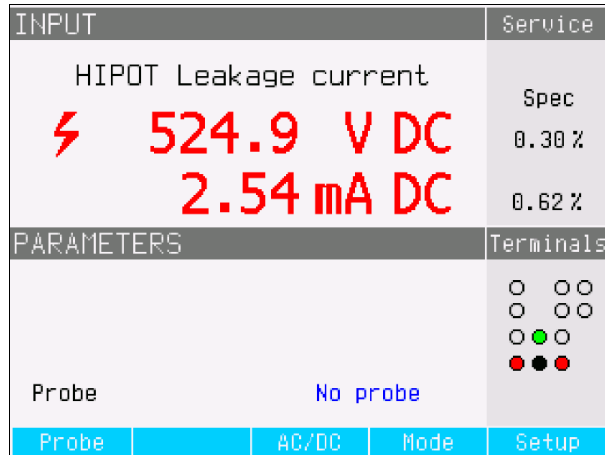

ehq64.bmp

Figure 7-27. Leakage Current Calibrator Display

3. Set the Calibrator to ac or dc depending on the signal type in the UUT.
4. Set the output voltage level on the UUT and turn the UUT output voltage on.
5. The Calibrator senses the output voltage and measures simulated leakage current flowing through the Load.
6. To verify the leakage current performance on the UUT, compare the leakage current readings on the UUT with those on the Calibrator.

Note

The Calibrator input resistance is 10 MΩ ± 1 % connected in parallel with the Load.

For making hipot leakage current calibrations using voltages higher than 1000 V, use the 10 kV HV divider as shown in Figure 7-28 setting the Probe softkey on the Calibrator to 10 kV.

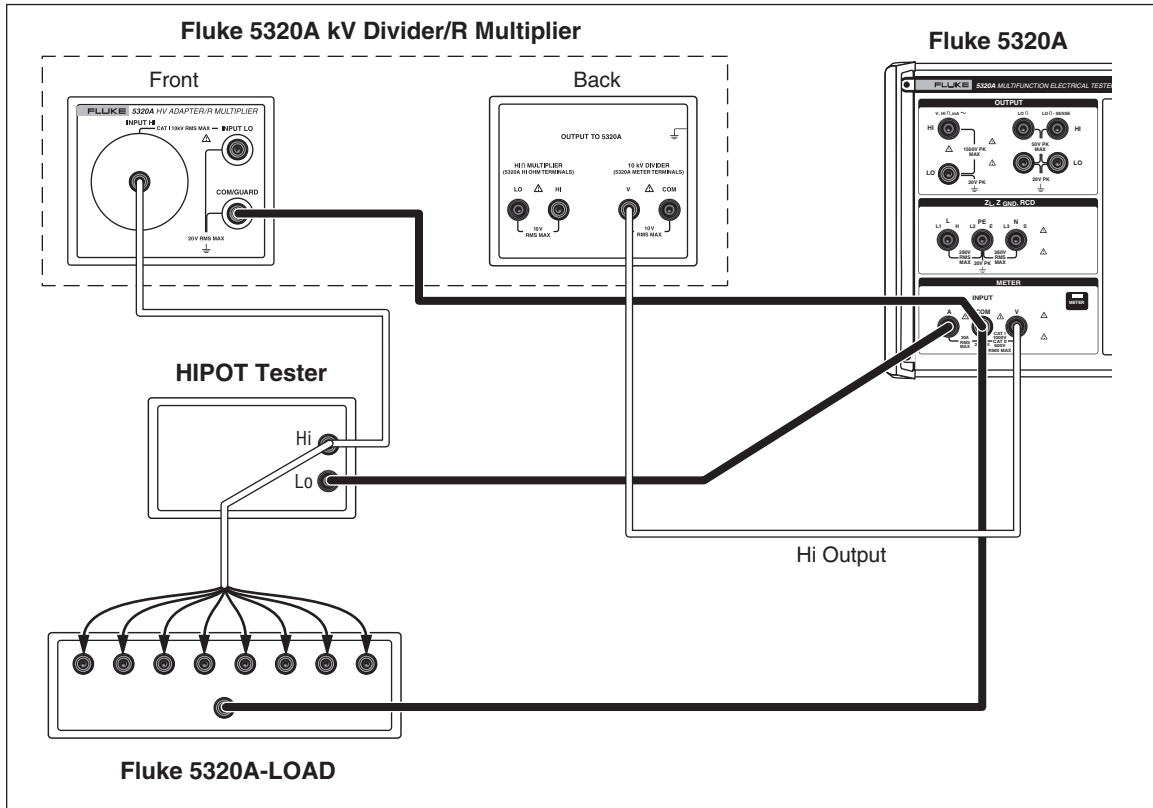

Figure 7-28. Hipot Calibration Using Voltage Above 1000 V

ehq063.eps

Note

The input resistance of the 10 kV HV divider adapter is approximately 300 MΩ ± 5%. The Calibrator senses and displays the current flowing through the Load and 10 kV HV divider adapter.

Appendices

Appendix	Title	Page
A	Errors.....	A-1

Appendix A

Errors

Introduction

Table A-1 lists the errors the Calibrator can generate. Each error has an ID, a message and a descriptive explanation.

Table A-1. List of Errors

ID	Message	Description
701,702	Output/Input overloaded	Input or output signal over specified limits. Decrease signal level.
703	Temperature too high.	Calibrator power stage overheated. Disconnect external load.
704,705,706	Output/Input overloaded	Input or output signal over specified limits. Decrease signal level.
501	Eeprom write.	Eeprom write failed.
502	Eeprom read.	Eeprom read failed.
503	Eeprom error.	Eeprom data lost.
722	Unexpected crossing.	Error in internal communication.
721	Unknown function.	Error in internal communication.
731	Calibrator not ready	Error in internal communication.
732	Internal cpu RESET	Calibrator will be restarted.
742	Interface data	Error in internal communication.
744	Measurement not available	Error in internal communication.
743	Interface receive	Error in internal communication.
745	I/c ready timeout.	Error in internal communication.

Table A-1. List of Errors (cont.)

ID	Message	Description
-410	Interrupted.	Remote interface error. A command was received which sends data to the output buffer, but the output buffer contained data from a previous command. The output buffer is cleared when power has been off, or after reset command has been executed.
-420	Unterminated.	Remote interface error. The calibrator was addressed to talk but a command has not been received which sends data to the output buffer.
-430	Deadlocked.	Remote interface error. A command was received which generates too much data to fit in the output buffer and the output buffer is full. Command execution continues but all data is lost.
-363	Input buffer overrun	Remote interface error.
-110	Command header	Remote interface error. A command was received that is not valid for the calibrator. You may have misspelled the command or it may not be a valid command.
-103	Invalid separator	Remote interface error. An invalid separator was found in command string. You may have used a comma instead of a colon, semicolon, or blank space – or you may have used blank space instead of comma.
-120	Numeric data	Remote interface error.
-140	Character data	Remote interface error.
-220	Invalid parameter	Remote interface error. An invalid character string was received. Check to see if you have enclosed the character string in single or double quotes and that the string contains valid ASCII character.
651	Impedance too high.	Residual impedance is too high (SCAN, COMP). Don't use SACN and COMP mode in Loop/Line impedance function or connect the calibrator to the socket with lower residual impedance.
661	Test voltage too high.	External test voltage too high. Use lower test voltage on DUT
662	Test voltage unstable.	External test voltage is not stable.
711	Value too large.	Set up value too large. Set value in specified limits.
712	Value too small.	Set up value too small. Set value in specified limits.
713	Negative value.	Negative value is not permitted. Don't set negative value.
801	Option not installed.	Selected function is not available. Option not installed.
	Current timeout.	Maximum thermal load in ground bond, loop/line resistance has been reached. Calibrator disconnected output terminals. Leave the calibrator in STANDBY mode for 5 minutes.

Table A-1. List of Errors (cont.)

ID	Message	Description
707	Output/Input overload.	Loop/line compensator overloaded. Wait 10 seconds and switch output terminals again.
709	Temperature too high.	Temperature overheating of ground bond resistance decade. Use UUT lower test current or wait 2 minutes before next calibration.
714	High series resistance	Series resistance selected in RCD function is too high. Choose lower serial resistance parameter Rxx.

Index

—A—

- AC Voltage Calibration, 4-30
- Accessories, 1-8
- Active Leakage current
 - Calibration for, 4-20
- Air Filter
 - Cleaning of, 6-4

—B—

- Beeper
 - Enabling/disabling, 3-13
 - setting the volume of, 3-13

—C—

- Cleaning
 - Air filter, 6-4
 - Exterior, 6-5
- Controls
 - Front panel, 3-3
 - Knob control, 3-11
- Controls, 3-3
 - Numeric keyboard, 3-10
 - Rear panel, 3-7

—D—

- Date
 - Setting system, 3-13
- DC Voltage Calibration, 4-30
- Device information
 - display of, 3-14
- Display
 - Features explained, 3-8
 - Setting brightness, 3-14

—E—

- English help guide, 3-10

Error

- list of, 3-16
 - messages, general, 3-15
- Error queue, 5-48
- Ethernet
 - Port setup, 5-5
 - Using of, 5-5
- Event Status Register, 5-46
- Example Calibration
 - Insulation Resistance, 7-5
- Example Calibrations
 - AC and DC Voltage, 7-21
 - Continuity and Resistance, 7-3
 - Current Meters, 7-24
 - Earth Resistance, 7-4
 - Ground Bond Resistance, 7-10
 - Leakage Current, 7-16
 - Line impedance, 7-13
 - Loop Impedance, 7-15
 - Residual Current Devices (RCD), 7-18
 - Using High Voltage probe, 7-25

—F—

- Failure
 - What to do in case of, 6-5
- Fluke
 - contacting of, 1-8
- French help guide, 3-10
- Front Panel
 - controls, 3-3
- Function
 - selection of, 3-9
- Function descriptions, 1-3
- Fuses
 - Accessing of, 6-3
 - Line-Power, 6-3
 - Measurement input, 6-4
 - replacing, 2-5

—G—

German help guide, 3-10
Ground bond Resistance
Setting of, 4-8

—H—

High Resistance
setting of, 4-5
HP-34401 supported commands, 5-8

—I—

IEEE 488
Bus restrictions, 5-3
Common Commands, 5-43
Interface configuration, 5-48
port setup, 5-3
Inspecting calibrator, 2-3
Italian help guide, 3-10

—K—

Knob control, 3-11

—L—

LAN. *See* Ethernet
language selection in help guide, 3-10
Leakage Current Calibration, 4-18
Active, 4-20
Passive, 4-18
Substitute, 4-21
Line Impedance
Setting of, 4-12
Line Voltage Selection, 2-5
Loop Impedance
Setting of, 4-12
Low Resistance
Setting of, 4-3

—M—

Manuals
description of, 1-4
Multimeter
Measuring with, 4-32

—N—

Numeric keyboard, 3-10

—O—

Operation
AC Voltage Calibration, 4-30
Active Leakage current, 4-20
DC Voltage Calibration, 4-30
Ground Bond Resistance Output, 4-8
High Resistance output, 4-5

Leakage Current Calibration, 4-18
Loop and Line Impedance Output, 4-12
Low Resistance output, 4-3
Passive Leakage current, 4-18
RCD Test Calibration, 4-23
RCD Trip Current, 4-23
RCD Trip Time, 4-26
rules for, 2-7
Selecting a function, 3-9
Setting output signal, 3-10
Substitute Leakage Current, 4-21
Verifying Calibrator, 6-6
Operation Status Register, 5-47
Output Queue, 5-48
Output Terminas
Connection/Disconnection, 3-12

—P—

Package contents, 2-3
Passive Leakage Current
Calibrating for, 4-18
Password
Setting calibration, 3-14
Performance
Verifying calibrator, 6-6
Power Considerations, 2-4
Power cord, 2-4
Power on, 2-6

—Q—

Questionable Status Register, 5-47

—R—

Rack mount, 2-5
RCD
Test Calibration, General info, 4-23
Trip Current calibration, 4-23
Trip Time calibration, 4-26
Readings, 3-12
Rear Panel
Controls, 3-7
Remote Control
Error queue, 5-48
Ethernet setup, 5-5
Event Status Register, 5-46
IEEE Common commands, 5-43
IEEE Interface configuration, 5-48
IEEE, Using of, 5-3
Operation Status Register, 5-47
Output commands, 5-17
Output queue, 5-48
Questionable Status Register, 5-47
RS-232 Exceptions, 5-5
RS-232 port setup, 5-4
SCPI Command summary, 5-8

-
- SCPI Commands, 5-7
 - Service Request Register, 5-46
 - Source commands, 5-17
 - Status Byte Register, 5-45
 - Status subsystem, 5-42
 - Syntax Information, 5-6
 - System commands, 5-40
 - Terminators, 5-7
 - Residual Impedance Correction
 - Sanning for, 4-16
 - Selecting of, 4-15
 - Setting of, 4-16
 - RS-232
 - Connector pinout, 5-5
 - Exceptions for remote control, 5-5
 - port setup, 5-4
 - Rules
 - of operation, 2-7
- S—**
- Safety, 1-5
 - General summary, 1-5
 - symbols, 1-7
 - SCPI
 - Abbreviations, description of, 5-8
 - Command summary, 5-8
 - Output commands, 5-17
 - Source commands, 5-17
 - Status commands, 5-42
 - System commands, 5-40
 - SCPI Commands, 5-7
- Serial number
 - display of, 3-14
 - Service Request Enable Register, 5-46
 - Setup
 - Menu, 3-12
 - Software version
 - display of, 3-14
 - Spanish help guide, 3-10
 - Status Byte Registers, 5-45
 - Substitute Leakage Current
 - Calibration for, 4-21
 - Syntax
 - Information, 5-6
 - Rules, 5-6
- T—**
- Time
 - Setting system, 3-13
- U—**
- Unpacking calibrator, 2-3
- V—**
- Verification
 - Calibrator performance, 6-6
- W—**
- Warm-up, 2-7