

**FLUKE**®

**Hart Scientific**®

# **7196 LN<sub>2</sub> Comparator**

*User's Guide*

## **Limited Warranty & Limitation of Liability**

Each product from Fluke Corporation, Hart Scientific Division (“Hart”) is warranted to be free from defects in material and workmanship under normal use and service. The warranty period is one year for the LN2 Comparator. The warranty period begins on the date of the shipment. Parts, product repairs, and services are warranted for 90 days. The warranty extends only to the original buyer or end-user customer of a Hart authorized reseller, and does not apply to fuses, disposable batteries or to any other product, which in Hart’s opinion, has been misused, altered, neglected, or damaged by accident or abnormal conditions of operation or handling. Hart warrants that software will operate substantially in accordance with its functional specifications for 90 days and that it has been properly recorded on non-defective media. Hart does not warrant that software will be error free or operate without interruption.

Hart authorized resellers shall extend this warranty on new and unused products to end-user customers only but have no authority to extend a greater or different warranty on behalf of Hart. Warranty support is available if product is purchased through a Hart authorized sales outlet or Buyer has paid the applicable international price. Hart reserves the right to invoice Buyer for importation costs of repairs/replacement parts when product purchased in one country is submitted for repair in another country.

Hart’s warranty obligation is limited, at Hart’s option, to refund of the purchase price, free of charge repair, or replacement of a defective product which is returned to a Hart authorized service center within the warranty period.

To obtain warranty service, contact your nearest Hart authorized service center or send the product, with a description of the difficulty, postage, and insurance prepaid (FOB Destination), to the nearest Hart authorized service center. Hart assumes no risk for damage in transit. Following warranty repair, the product will be returned to Buyer, transportation prepaid (FOB Destination). If Hart determines that the failure was caused by misuse, alteration, accident or abnormal condition or operation or handling, Hart will provide an estimate or repair costs and obtain authorization before commencing the work. Following repair, the product will be returned to the Buyer transportation prepaid and the Buyer will be billed for the repair and return transportation charges (FOB Shipping Point).

THIS WARRANTY IS BUYER’S SOLE AND EXCLUSIVE REMEDY AND IS IN LIEU OF ALL OTHER WARRANTIES, EXPRESS OR IMPLIED, INCLUDING BUT NOT LIMITED TO ANY IMPLIED WARRANTY OF MERCHANTABILITY OR FITNESS FOR A PARTICULAR PURPOSE. HART SHALL NOT BE LIABLE FOR ANY SPECIAL, INDIRECT, INCIDENTAL, OR CONSEQUENTIAL DAMAGES OR LOSSES, INCLUDING LOSS OF DATA, WHETHER ARISING FROM BREACH OF WARRANTY OR BASED ON CONTRACT, TORT, RELIANCE OR ANY OTHER THEORY.

Since some countries or states do not allow limitation of the term of an implied warranty, or exclusion or limitation of incidental or consequential damages, the limitations and exclusions of this warranty may not apply to every buyer. If any provision of this Warranty is held invalid or unenforceable by a court of competent jurisdiction, such holding will not affect the validity or enforceability of any other provision.

### **Fluke Corporation, Hart Scientific Division**

799 E. Utah Valley Drive • American Fork, UT 84003-9775 • USA  
Phone: +1.801.763.1600 • Telefax: +1.801.763.1010  
E-mail: support@hartscientific.com

**[www.hartscientific.com](http://www.hartscientific.com)**

Subject to change without notice. • Copyright © 2007 • Printed in USA

# Table of Contents













<b>1</b>	<b>Before You Start</b>	<b>1</b>
1.1	Symbols Used	1
1.2	Safety Information	2
1.2.1	Warnings	2
1.2.2	Cautions	3
1.3	Hart Scientific Authorized Service Centers	3
<b>2</b>	<b>Introduction</b>	<b>5</b>
<b>3</b>	<b>Specifications</b>	<b>6</b>
<b>4</b>	<b>Description</b>	<b>7</b>
<b>5</b>	<b>Operation</b>	<b>8</b>



# 1 Before You Start

## 1.1 Symbols Used

Table 1 lists the International Electrical Symbols. Some or all of these symbols may be used on the instrument or in this manual.

**Table 1** International Electrical Symbols

Symbol	Description
	AC (Alternating Current)
	AC-DC
	Battery
	CE Complies with European Union Directives
	DC
	Double Insulated
	Electric Shock
	Fuse
	PE Ground
	Hot Surface (Burn Hazard)
	Read the User's Manual (Important Information)
	Off
	On

Symbol	Description
	Canadian Standards Association
<b>CAT II</b>	OVERVOLTAGE (Installation) CATEGORY II, Pollution Degree 2 per IEC1010-1 refers to the level of Impulse Withstand Voltage protection provided. Equipment of OVERVOLTAGE CATEGORY II is energy-consuming equipment to be supplied from the fixed installation. Examples include household, office, and laboratory appliances.
	C-TIC Australian EMC Mark
	The European Waste Electrical and Electronic Equipment (WEEE) Directive (2002/96/EC) mark.

## 1.2 Safety Information

Use this instrument only as specified in this manual. Otherwise, the protection provided by the instrument may be impaired.

The following definitions apply to the terms “Warning” and “Caution”.

- “Warning” identifies conditions and actions that may pose hazards to the user.
- “Caution” identifies conditions and actions that may damage the instrument being used.

### 1.2.1

#### Warnings

To avoid personal injury, follow these guidelines.

When handling and working with the Dewar, user should wear appropriate safety equipment. Vacuum flask can shatter unexpectedly and may cause injury.

Regional or user specific safety regulations referring to glass apparatuses, liquefied gasses, laboratory devices, vacuum insulated glass containers, etc., must be strictly followed.

The Dewar can be used up to just under 0.1 bar pressure. **DO NOT** use the Dewar at pressures higher than 0.1 bar.

Before using the Dewar, perform a complete inspection of the Dewar for scratches, cracks, chips or other flaws. A Dewar with surface flaws that will be subjected to mechanical or thermal stresses cannot be used due to the threat of implosion.

To insure the safety, quality and function of the Dewar, only use the Dewar from  $-200^{\circ}\text{C}$  to  $+150^{\circ}\text{C}$ .

**DO NOT** use the Dewar with liquid or gaseous Helium. The Dewar is not designed for use with Helium.

## 1.2.2



### Cautions

To avoid possible damage to the instrument, follow these guidelines.

**Prior to first use**, the following must be performed to ensure proper function of a new Dewar:

- After removing all packing materials from the inside of the Dewar, wash Dewar with hot, soapy water and rinsing with Distilled or DI water and either air dry or use a lint free towel. This is to ensure a clean, dry and contaminate free Dewar.
- The Dewar needs to be tempered. Insure that the instrument is tempered before filling the vessel with extremely hot or cold liquids. The Dewar can be tempered by rinsing it with a small amount of lukewarm liquid, cool liquid or liquid gas before first use.

The Dewar on the instrument is covered with a protective plastic mesh. Due to the added protection that the mesh provides, it is recommended that the mesh be left on the Dewar.

Due to low coefficient of expansion and resistance to thermal shock, containers made of borosilicate glass are recommended for extreme temperature use.

Dewar containers are maintenance- free. If the user finds it necessary to clean the Dewar, great care must be taken to insure that the surface of the Dewar is not damaged. **DO NOT** clean the Dewar with metal, ceramic or other abrasive objects.

## 1.3

### Hart Scientific Authorized Service Centers

Please contact one of the following authorized Service Centers to coordinate service on your Hart product:

#### **Hart Scientific, Inc.**

799 E. Utah Valley Drive  
American Fork, UT 84003-9775  
USA

Phone: +1.801.763.1600  
Telefax: +1.801.763.1010  
E-mail: support@hartscientific.com

#### **Fluke Nederland B.V.**

Customer Support Services  
Science Park Eindhoven 5108  
5692 EC Son

NETHERLANDS

Phone: +31-402-675300

Telefax: +31-402-675321

E-mail: ServiceDesk@fluke.nl

**Fluke Int'l Corporation**

Service Center - Instrimpex

Room 2301 Sciteck Tower

22 Jianguomenwai Dajie

Chao Yang District

Beijing 100004, PRC

CHINA

Phone: +86-10-6-512-3436

Telefax: +86-10-6-512-3437

E-mail: xingye.han@fluke.com.cn

**Fluke South East Asia Pte Ltd.**

Fluke ASEAN Regional Office

Service Center

60 Alexandra Terrace #03-16

The Comtech (Lobby D)

118502

SINGAPORE

Phone: +65 6799-5588

Telefax: +65 6799-5588

E-mail: antng@singa.fluke.com

When contacting these Service Centers for support, please have the following information available:

- Model Number
- Serial Number
- Complete description of the problem

## 2 Introduction

A comparison calibration at the temperature of liquid nitrogen is generally used to calibrate standard platinum resistance thermometers (SPRTs) and other temperature probes below

$-100^{\circ}\text{C}$ . Since the lowest temperature limit of a bath is around  $-100^{\circ}\text{C}$ , most national and other calibration laboratories use a liquid nitrogen comparator instead of a bath for comparison calibrations at the triple point of argon ( $-189.3442^{\circ}\text{C}$ ). The boiling point of nitrogen ( $-195.798^{\circ}\text{C}$ ) provides a useful and attractive calibration point. Your new liquid nitrogen comparator has been developed at Hart Scientific according to Xumo Li's many years experience in thermometry. The new liquid nitrogen comparator can be used to calibrate SPRTs, RTDs, various thermocouples and other probes by comparison with a reference thermometer. The new equipment is simple in design and easy to use. No electrical power is required for operation.

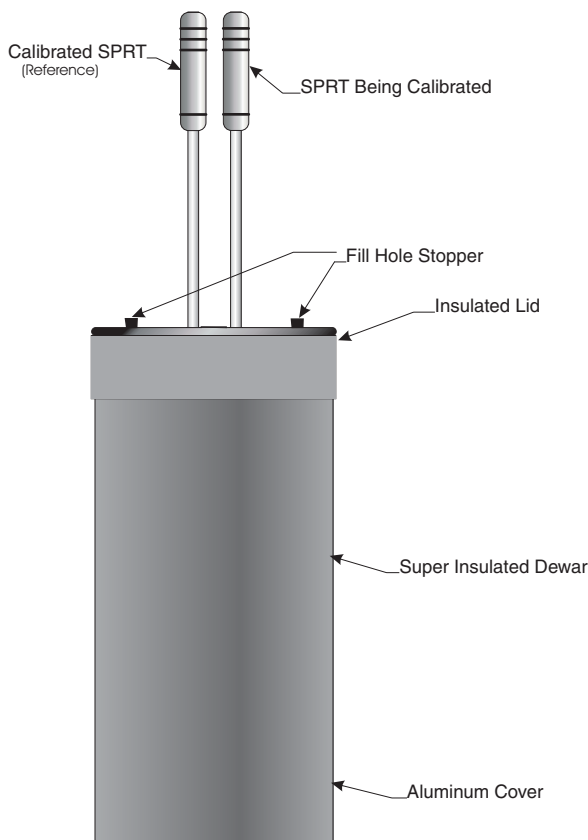

**Figure 1** The liquid nitrogen comparator



### 3 Specifications

Specification	7196-4	7196-13
Temperature <sup>†</sup>	-196 °C	
Uniformity	< 0.4 mK (0.0004 °C) between holes	
Stability <sup>‡</sup>	Typically better than 2 mK / 20 min.	
Thermal Wells	<b>4 Wells:</b> 8 mm (0.32 inches) I.D.	<b>5 Wells:</b> 8 mm (0.32 inches) I.D. <b>8 Wells:</b> 6.35 mm (0.25 inches) I.D.
Immersion	275 mm (10.8 inches) [from top of lid to bottom of well] 150 mm (5.9 inches) [copper block]	
Evaporation	Approximately 25 mm (1 inch) per 45 minutes	
Volume	3.5 liters (0.92 gallons)	
Outer diameter	180 mm (7.09 inches)	
Height	385 mm (15.16 inches)	
<sup>†</sup> Actual results depend on atmospheric pressure. If liquid argon is used, temperature is -186 °C. <sup>‡</sup> The equilibrium temperature will change with the atmospheric pressure ( $dt/dp \approx 0.085$ mK/Pa). The actual temperature stability depends on atmospheric pressure stability.		

## 4 Description

The Hart Scientific Liquid Nitrogen Comparator Model 7196 (Figure 2) consists of a Pyrex™ Dewar Flask, a lid, a connection rod and an oxygen-free copper block with four wells to accommodate thermometers to be calibrated. During use the oxygen-free copper block is completely immersed in liquid nitrogen. Up to four thermometers, including a reference thermometer as the standard for comparison calibration, are directly immersed in the liquid nitrogen inside the block. The boiling temperature of nitrogen depends on the atmospheric pressure. If the pressure is stable, the liquid nitrogen temperature will be stable and uniform also. The oxygen-free copper has extremely good thermal conductivity, therefore, the copper block will enhance the temperature uniformity in the comparator greatly.

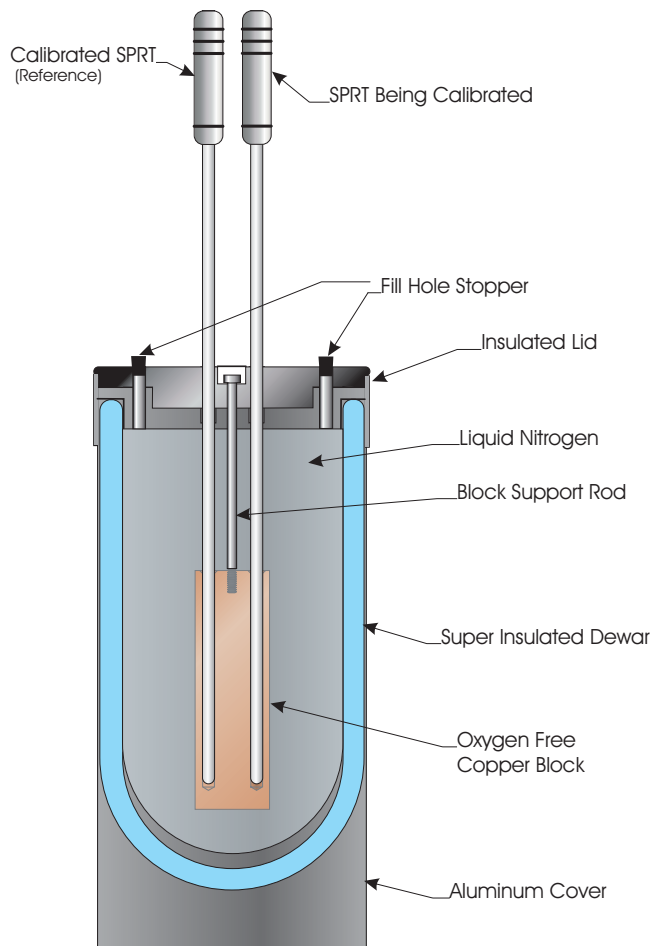

**Figure 2** Cut-Away View of Liquid Nitrogen Comparator

## 5 Operation

**Prior to first use**, the following must be performed to ensure proper function of a new Dewar:

- After removing all packing materials from the inside of the Dewar, wash Dewar with hot, soapy water and rinsing with Distilled or DI water and either air dry or use a lint free towel. This is to ensure a clean, dry and contaminate free Dewar.
- The Dewar needs to be tempered. Insure that the instrument is tempered before filling the vessel with extremely hot or cold liquids. The Dewar can be tempered by rinsing it with a small amount of lukewarm liquid, cool liquid or liquid gas before first use.

In order to fill and use the instrument, use the following steps:

1. Remove the lid and fill the Dewar 2/3 full of liquid nitrogen being careful not to splash any on your skin.

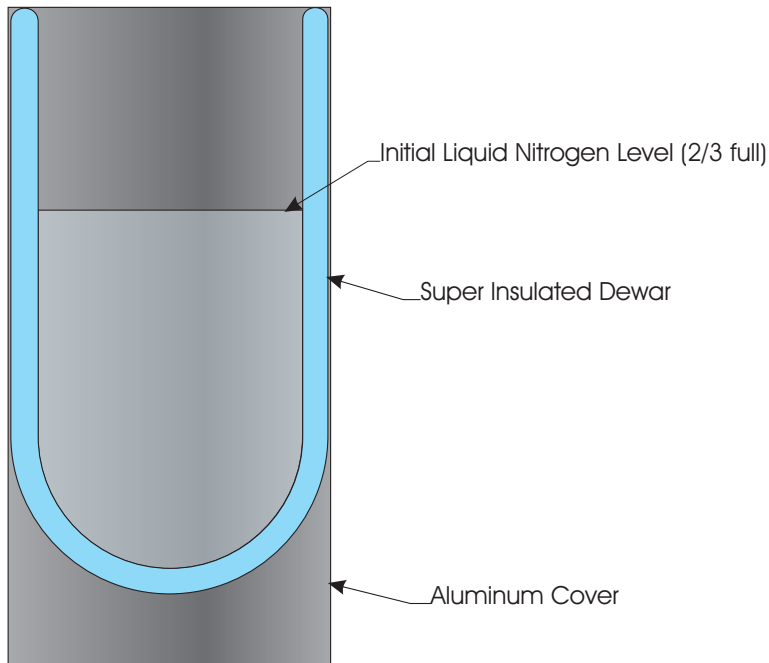

**Figure 3** Initial Liquid Nitrogen Level in Comparator

2. Immerse the oxygen-free copper block in the liquid nitrogen slowly over a period of approximately ten minutes. When the room temperature block touches the liquid nitrogen, the liquid nitrogen will boil violently.

After insertion, wait until the liquid nitrogen stops boiling before proceeding to Step 3.

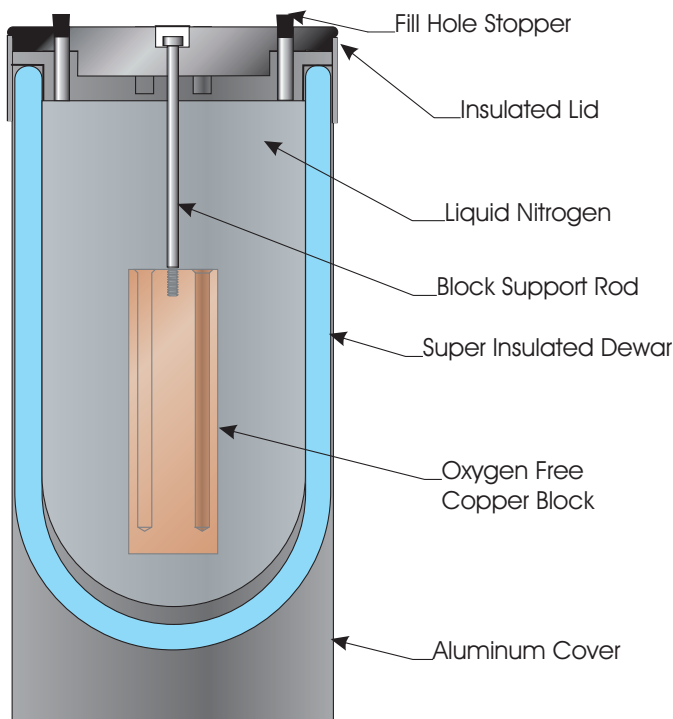

**Figure 4** Insert Oxygen Free Copper Block into Comparator

3. Check that the lid is securely in place. Insert SPRTs or other types of temperature probes to be calibrated into the liquid nitrogen and into the wells in the block. (See Figure 2)
4. Remove one of the rubber stoppers in the lid and use a paper funnel to add more liquid nitrogen to the Dewar until the level is about 5 mm below the lid. Put the stopper back in the lid. It will take thirty minutes or a little longer to reach equilibrium.
5. When thermal equilibrium is reached, perform the comparison calibrations just as you do with a temperature calibration bath.
6. About every four hours add more liquid nitrogen to the Dewar. Remove one of the stoppers from the lid and pour liquid nitrogen into the Dewar through a paper funnel to a level about 5 mm below the lid. Be sure to replace the stopper.