

FLUKE®

Hart Scientific®

7900
*Temperature Controller
User's Guide*

Limited Warranty & Limitation of Liability

Each product from Fluke Corporation, Hart Scientific Division ("Hart") is warranted to be free from defects in material and workmanship under normal use and service. The warranty period is 2 years for the Temperature Controller. The warranty period begins on the date of the shipment. Parts, product repairs, and services are warranted for 90 days. The warranty extends only to the original buyer or end-user customer of a Hart authorized reseller, and does not apply to fuses, disposable batteries or to any other product, which in Hart's opinion, has been misused, altered, neglected, or damaged by accident or abnormal conditions of operation or handling. Hart warrants that software will operate substantially in accordance with its functional specifications for 90 days and that it has been properly recorded on non-defective media. Hart does not warrant that software will be error free or operate without interruption. Hart does not warrant calibrations on the Temperature Controller.

Hart authorized resellers shall extend this warranty on new and unused products to end-user customers only but have no authority to extend a greater or different warranty on behalf of Hart. Warranty support is available if product is purchased through a Hart authorized sales outlet or Buyer has paid the applicable international price. Hart reserves the right to invoice Buyer for importation costs of repairs/replacement parts when product purchased in one country is submitted for repair in another country.

Hart's warranty obligation is limited, at Hart's option, to refund of the purchase price, free of charge repair, or replacement of a defective product which is returned to a Hart authorized service center within the warranty period.

To obtain warranty service, contact your nearest Hart authorized service center or send the product, with a description of the difficulty, postage, and insurance prepaid (FOB Destination), to the nearest Hart authorized service center. Hart assumes no risk for damage in transit. Following warranty repair, the product will be returned to Buyer, transportation prepaid (FOB Destination). If Hart determines that the failure was caused by misuse, alteration, accident or abnormal condition or operation or handling, Hart will provide an estimate or repair costs and obtain authorization before commencing the work. Following repair, the product will be returned to the Buyer transportation prepaid and the Buyer will be billed for the repair and return transportation charges (FOB Shipping Point).

THIS WARRANTY IS BUYER'S SOLE AND EXCLUSIVE REMEDY AND IS IN LIEU OF ALL OTHER WARRANTIES, EXPRESS OR IMPLIED, INCLUDING BUT NOT LIMITED TO ANY IMPLIED WARRANTY OF MERCHANTABILITY OR FITNESS FOR A PARTICULAR PURPOSE. HART SHALL NOT BE LIABLE FOR ANY SPECIAL, INDIRECT, INCIDENTAL, OR CONSEQUENTIAL DAMAGES OR LOSSES, INCLUDING LOSS OF DATA, WHETHER ARISING FROM BREACH OF WARRANTY OR BASED ON CONTRACT, TORT, RELIANCE OR ANY OTHER THEORY.

Since some countries or states do not allow limitation of the term of an implied warranty, or exclusion or limitation of incidental or consequential damages, the limitations and exclusions of this warranty may not apply to every buyer. If any provision of this Warranty is held invalid or unenforceable by a court of competent jurisdiction, such holding will not affect the validity or enforceability of any other provision.

Fluke Corporation, Hart Scientific Division

799 E. Utah Valley Drive • American Fork, UT 84003-9775 • USA

Phone: +1.801.763.1600 • Telefax: +1.801.763.1010

E-mail: support@hartscientific.com

www.hartscientific.com

Subject to change without notice. • Copyright © 2005 • Printed in USA

Table of Contents

1	Before You Start	1
1.1	Symbols Used	1
1.2	Safety Information	2
1.2.1	WARNINGS	2
1.2.2	CAUTIONS	4
1.3	Authorized Service Centers.	5
2	Introduction	7
3	Specifications and Environmental Conditions	9
3.1	Specifications	9
3.2	Environmental Conditions	9
4	Quick Start	11
4.1	Unpacking	11
4.2	Installation	11
4.2.1	Setup	11
4.2.2	Heater/Stirrer/LN Cooling	11
4.2.2.1	Heater Connection	11
4.2.2.2	Stir Motor Connection	13
4.2.2.3	LNConnection	13
4.2.3	Control Probe	14
4.2.4	Thermocouple Probe	14
4.2.5	Power	14
4.2.6	Fuses	14
4.2.7	Power Cord	15
4.3	Setting the Temperature	15
5	Parts and Controls	17
5.1	Front Panel	17
5.2	Back Panel	18
6	General Operation	21
6.1	Control System	21
6.2	Power	21
6.3	Heater	21
6.4	LN Cooling	22
6.5	Temperature Controller	22

7	Controller Operation	23
7.1	Process Temperature	23
7.2	Reset Cut-out	23
7.3	Temperature Set-point	25
7.3.1	Programmable Set-points	25
7.3.2	Set-point Value	25
7.3.3	Set-point Vernier	26
7.4	Temperature Scale Unit	27
7.5	Scan	27
7.5.1	Scan Control	28
7.5.2	Scan Rate	28
7.6	Ramp and Soak Program	28
7.6.1	Number of Program Set-points	29
7.6.2	Set-points	29
7.6.3	Program Soak Time	30
7.6.4	Program Function Mode	30
7.6.5	Program Control	31
7.7	Secondary Menu	31
7.8	Heater Power	31
7.9	Proportional Band	32
7.10	Cutout	33
7.11	Controller Configuration	34
7.12	Probe Parameters RTD Sensor	34
7.12.1	R	35
7.12.2	ALPHA	35
7.13	Operating Parameters	35
7.13.1	Cutout Reset Mode	35
7.13.2	Soak Stability	36
7.13.3	Boost Temperature Offset	36
7.14	Serial Interface Parameters	36
7.14.1	Baud Rate	36
7.14.2	Sample Period	37
7.14.3	Duplex Mode	37
7.14.4	Linefeed	38
7.15	IEEE-488 Parameters	38
7.15.1	IEEE-488 Address	38
7.15.2	Termination	39
7.16	Calibration Parameters	39
7.16.1	CTO	40
7.16.2	CO and CG	40
7.16.3	H and L	40
7.16.4	SCO	40

8	Digital Communication Interface	41
8.1	Serial Communications	41
8.1.1	Wiring	41
8.1.2	Setup	41
8.1.2.1	Baud Rate	42
8.1.2.2	Sample Period	42
8.1.2.3	Duplex Mode	42
8.1.2.4	Linefeed	42
8.1.3	Serial Operation	43
8.1.4	IEEE-488 Communication	43
8.1.4.1	Setup and Address Selection	43
8.1.4.2	IEEE-488 Operation	43
8.2	Interface Commands	43
8.3	Power Control Functions	44
8.3.1	Heater Control	44
8.3.2	Cooling Control	44
9	Calibration Procedure	49
9.1	RTD Probe Calibration	49
9.1.1	Calibration Points	49
9.1.2	Measuring the Set-point Error	49
9.1.3	Computing R and ALPHA	49
9.1.4	Calibration Example	50
10	Maintenance	53
11	Troubleshooting.	55
11.1	Troubleshooting	55
12	Appendix - 910 Bath Probe Adapter Instructions	59
12.1	TC Cut-Out	59
12.2	Control Probe	59
12.3	Attaching the Probe Adapter	60
12.4	Inserting the Probes	60

Figures and Tables













Table 1	International Electrical Symbols	1
Figure 1	Old heater configuration	12
Figure 2	Present heater configuration	12
Figure 3	Terminal Block	13
Figure 4	Front Control Panel	17
Figure 5	Back Panel	18
Figure 6	Controller Flow Chart	24
Table 2	Program mode setting actions	30
Figure 7	Temperature fluctuations at various proportional band settings	32
Figure 8	Serial Communications Cable Wiring	41
Table 3	Serial Interface Commands	45
Table 4	Serial Interface Commands continued	46
Table 5	Serial Interface Commands continued	47
Table 6	Power Control Functions.	48
Figure 9	Calibration Example — Platinum RTD Probe	51
Figure 10	Probe Adapter	59



1 Before You Start

1.1 Symbols Used

Table 1 lists the International Electrical Symbols. Some or all of these symbols may be used on the instrument or in this manual.

Table 1 International Electrical Symbols

Symbol	Description
	AC (Alternating Current)
	AC-DC
	Battery
	Complies with European Union directives
	DC
	Double Insulated
	Electric Shock
	Fuse
	PE Ground
	Hot Surface (Burn Hazard)
	Read the User's Manual (Important Information)
	Off
	On

Symbol	Description
	Canadian Standards Association
CAT II	OVERVOLTAGE (Installation) CATEGORY II, Pollution Degree 2 per IEC1010-1 refers to the level of Impulse Withstand Voltage protection provided. Equipment of OVERVOLTAGE CATEGORY II is energy-consuming equipment to be supplied from the fixed installation. Examples include household, office, and laboratory appliances.
	C-TIC Australian EMC mark
	The European Waste Electrical and Electronic Equipment (WEEE) Directive (2002/96/EC) mark.

1.2 Safety Information

Use this instrument only as specified in this manual. Otherwise, the protection provided by the instrument may be impaired. Refer to the safety information in Table 2.

The following definitions apply to the terms “Warning” and “Caution”.

- “WARNING” identifies conditions and actions that may pose hazards to the user.
- “CAUTION” identifies conditions and actions that may damage the instrument being used.

1.2.1 WARNINGS

To avoid personal injury, follow these guidelines.

GENERAL

DO NOT use the instrument for any application other than calibration work. The instrument was designed for temperature calibration. Any other use of the instrument may cause unknown hazards to the user.

DO NOT use the instrument in environments other than those listed in the user's guide.

Follow all safety guidelines listed in the user's manual.

Calibration Equipment should only be used by Trained Personnel.

If this instrument is used in a manner not specified by the manufacturer, the protection provided by the instrument may be impaired.

If the instrument is used to control a calibration heat source, insure the heater is wired correctly to the corresponding position on the internal strip as labeled. The heater will heat continually if the heater and stirrer power are swapped (see Figure 3 on page 13).

Before initial use, or after transport, or after storage in humid or semi-humid environments, or anytime the dry-well has not been energized for more than 10 days, the instrument needs to be energized for a “dry-out” period of 2 hours before it can be assumed to meet all of the safety requirements of the IEC-61010-1. If the product is wet or has been in a wet environment, take necessary measures to remove moisture prior to applying power such as storage in a low humidity temperature chamber operating at 50°C for 4 hours or more.

The instrument is intended for indoor use only.

The instrument is a precision instrument. Although it has been designed for optimum durability and trouble free operation, it must be handled with care.

Operate the instrument in room temperatures listed in Section 3.2, Environmental Conditions.

The instrument is vented and clearance of 3 inches (7.62 cm) is recommended above and around the sides the instrument.

DO NOT remove the feet attached to the bottom of the instrument. If the feet are removed, contact an Authorized Service Center for replacements.

DO NOT place the instrument on top of a calibration bath or dry-well where it would be in contact or direct path of heat.

DO NOT stack items on top of the instrument.

BURN HAZARD

The instrument can be used to control instruments which generate extreme temperatures. Precautions must be taken to prevent personal injury or damage to objects. Probes may be extremely hot or cold when removed from a calibration bath. Cautiously handle probes to prevent personal injury. Carefully place probes on a heat resistant surface or rack until they are at room temperature. Fires and severe burns may result if personnel fail to observe safety precautions.

ELECTRICAL HAZARD

These guidelines must be followed to ensure that the safety mechanisms in this instrument will operate properly. The instrument must be plugged into an appropriate outlet as specified in Section 2.1, Specifications, on page 7. Also, the current and voltage capability of the instrument must not be exceeded. The power cord of the instrument is equipped with a three-pronged grounding plug for your protection against electrical shock hazards. It must be plugged directly into a properly grounded three-prong receptacle. The receptacle must be installed in accordance with local codes and ordinances. Consult a qualified electrician. **DO NOT** use an extension cord or adapter plug.

DO use a ground fault interrupt device. This system that is controlled by this instrument may contain a fluid. A ground fault device is advised in case fluid is present in the electrical system and could cause an electrical shock.

Always replace the power cord with an approved cord of the correct rating and type. If you have questions, contact a Authorized Service Center (see Section 1.3).

High voltage is used in the operation of this equipment. Severe injury or death may result if personnel fail to observe the safety precautions. Before working inside the instrument, turn off the power and disconnect the power cord.

FLUIDS

Fluids used in the system controlled by this instrument may produce noxious or toxic fumes under certain circumstances. Consult the fluid manufacturer's MSDS (Material Safety Data Sheet). Proper ventilation and safety precautions must be observed.

The instrument is equipped with a soft cutout (adjustable parameter) and a hard cutout (set at the factory) Adjust the soft cutout according to fluid characteristics or application. As a guideline, the soft cutout should be set 10°C to 15°C below the flash point of the fluid (see Section 7.10, Cutout). Insure that the flash point, boiling point, or other key fluid characteristics are not exceeded.

1.2.2 **CAUTIONS**

To avoid possible damage to the instrument, follow these guidelines.

DO use a ground fault interrupt device.

Operate the instrument in room temperatures as listed in Section 3.2, Environmental Conditions.

Calibration constants should only be changed by trained personnel. The correct setting of these parameters is important to the safety and proper operation of the instrument.

The Factory Reset Sequence should be performed only by authorized personnel if no other action is successful in correcting a malfunction. You must have a copy of the most recent Report of Test to restore the test parameters.

The "cooling" outlet provided by the controller is for LN2 only. **DO NOT** connect mechanical cooling to the controller.

DO NOT operate this instrument in an excessively wet, oily, dusty, or dirty environment or place in locations where hot or cold liquids are splashed on it.

Most probes have handle temperature limits. Be sure that the probe handle temperature limit is not exceeded in the air above the system controlled by this instrument.

The instrument and any thermometer probes used with it are sensitive instruments that can be easily damaged. Always handle these devices with care. Do not allow them to be dropped, struck, stressed, or overheated.

DO NOT use this instrument in a system that exceeds the current capability of the instrument as listed in Section 3.1, Specifications.

DO NOT replace fuse(s) with one of a higher current rating or type. Always replace the fuse with one of the same rating, voltage, and type. The current rating listed in Section 3.1, Specifications, is the maximum for the instrument. If the instrument is connected to a system which uses less than the maximum capability of this instrument, the fuses need to be changed in order to be correct for the system. Once the instrument is connected to the system, the system current needs to be measured or calculated and the appropriate fuse size and characteristics selected. Section 4.2.6, Fuses, can be used as a guide for selecting a fuse.

Once the correct fuse type and rating is selected, the following information is applicable. The instrument is equipped with operator accessible fuses. If a fuse blows, it may be due to a power surge or failure of a component. Replace the fuses once. If a fuse blows a second time, it is likely caused by failure of a component. As a test disconnect the output device (heater) and apply power to the rest of the system. Check to see if the fuse(s) blow. If the fuse(s) blow only when an output device (heater, stirrer, etc.) is connected, the fault may be in the system component. If not, contact an Authorized Service Center (see Section 1.3).

If a mains supply power fluctuation occurs, immediately turn off the instrument. Power bumps from brown-outs and black-outs can damage the system. Wait until the power has stabilized before re-energizing the instrument.

For best accuracy, the instrument needs to be calibrated with the system it controls.

1.3 Authorized Service Centers

Please contact one of the following authorized Service Centers to coordinate service on your Hart product:

Fluke Corporation, Hart Scientific Division

799 E. Utah Valley Drive
American Fork, UT 84003-9775
USA

Phone: +1.801.763.1600
Telefax: +1.801.763.1010
E-mail: support@hartscientific.com

Fluke Nederland B.V.

Customer Support Services
Science Park Eindhoven 5108
5692 EC Son
NETHERLANDS

Phone: +31-402-675300
Telefax: +31-402-675321
E-mail: ServiceDesk@fluke.nl

Fluke Int'l Corporation

Service Center - Instrimpex
Room 2301 Sciteck Tower
22 Jianguomenwai Dajie
Chao Yang District
Beijing 100004, PRC
CHINA

Phone: +86-10-6-512-3436
Telefax: +86-10-6-512-3437
E-mail: xingye.han@fluke.com.cn

Fluke South East Asia Pte Ltd.

Fluke ASEAN Regional Office
Service Center
60 Alexandra Terrace #03-16
The Comtech (Lobby D)
118502
SINGAPORE

Phone: +65 6799-5588
Telefax: +65 6799-5588
E-mail: antng@singa.fluke.com

When contacting these Service Centers for support, please have the following information available:

- Model Number
- Serial Number
- Voltage
- Complete description of the problem

2 Introduction

The Hart Scientific Model 7900 is a solid state temperature controller specifically designed to control the temperature of Rosemount designed temperature calibration baths. The unique combination of analog and digital electronic circuitry provides exceptional accuracy and stability together with ease of operation and programmability.

Temperature sensing is done with a 4-wire 100-ohm platinum resistance probe that plugs into the back of the controller. To maintain a constant temperature, the controller adjusts the pulses of power supplied to the heater by means of a solid state relay.

The 7900 controller can be easily programmed via the four-button front panel or by the serial or IEEE interface. Programming allows the user to set the control temperature, temperature scale units to °C or °F, the proportional band, and the calibration variables. The process or actual temperature is continuously displayed on a bright green LED panel. The percent heating power may also be monitored.

An added safety device, the over-temperature cut-out, is also programmable. This built-in feature protects the system from fault conditions causing excessive temperature by disabling the heater if the temperature sensed by a separate thermocouple probe exceeds the cut-out set-point. Before using the 7900 controller you should understand the proper setup and operation.

3 Specifications and Environmental Conditions

3.1 Specifications

Temperature Range	-100 °C to 400 °C (-148 °F to 752 °F)
Accuracy	± 1.0 °C
Stability	± 0.003 °C (depends on application)
Stabilization Time	approximately 30 minutes (depends on system design)
Control Probe	100Ω RTD, 4 wire
Resolution	0.0002 °C/°F in high-resolution mode
Readout	Switchable °C or °F
Cooling Control	LN2 – automatic (requires optional LN2 valve box)
Controller	Hybrid Digital/Analog controller with data retention
Interface	RS-232 and IEEE standard
Fault Protection	High temperature cutout (Type K thermocouple input) Sensor burnout and short protection
Cutout Accuracy	± 10 °C
Combined Stir Motor Heater and LN2 Cooling Outputs (max)	115 VAC (±10%), 50/60 Hz, 15.8 A, 1815 W
Power (max)	115 VAC (±10%), 50/60 Hz, 16 A, 1840 W Note: Internal electronics require 0.2 A to operate.
System Fuses	20 A 250 V slow blow (max)
Heater Fuses	20 A 250 V fast acting (max)
Exterior Dimension	72 mm H x 172 mm W x 250 mm D (2.83 in x 6.75 in x 9.86 in)
Weight	4.0 kg (9 lbs.)
Safety	OVERVOLTAGE (Installation) CATEGORY II, Pollution Degree 2 per IEC-61010-1

3.2 Environmental Conditions

Although the instrument has been designed for optimum durability and trouble-free operation, it must be handled with care. The instrument should not be operated in an excessively dusty or dirty environment. Maintenance and cleaning recommendations can be found in the Maintenance Section of this manual.

The instrument operates safely under the following conditions:

- ambient temperature range: 5 - 50°C (41 - 122°F)
- ambient relative humidity: maximum 80% for temperature <31°C, decreasing linearly to 50% at 40°C
- pressure: 75kPa - 106kPa
- mains voltage within $\pm 10\%$ of nominal
- vibrations in the calibration environment should be minimized
- altitude less than 2,000 meters
- indoor use only

4 Quick Start

This section provides a brief summary of the steps required to set up and operate the 7900 temperature controller. This section should be used as a general overview and reference not as a substitute for the remainder of the manual. Please read Sections 4.2 through 6 carefully before operating the controller.

4.1 Unpacking

Unpack the controller carefully and inspect it for any damage that may have occurred during shipment. If there is shipping damage, notify the carrier immediately.

An RTD control probe and a thermocouple cut-out probe should have been purchased along with the controller.

Verify that the following components are present:

- 7900 Controller with attached power cord
- Control Probe
- Thermocouple Probe
- User's Guide
- Probe Adapter (2)
- Extra power cord (15 Amp)

4.2 Installation

4.2.1 Setup

The 7900 controller is a precision instrument that should be located in an appropriate environment. The location should be free from excessive dirt, moisture, vibration, or temperature variations. There should be no present danger of spilled liquids.

4.2.2 Heater/Stirrer/LN₂ Cooling

In order to access the terminal block connectors (Figure 3) for the heater, stirrer motor, and LN₂ Cooling, remove the top cover of the controller.

4.2.2.1 Heater Connection



CAUTION: READ THIS ENTIRE PROCEDURE BEFORE CONNECTING THE HEATERS!

This controller can be used with the following heater assemblies. If the heater assembly that you are using is not listed, please call Hart Scientific Customer Service for assistance.

Part number	Power	Resistance
00910-0125-0001	260/440 W	50/30 Ohms
00910-0126-0001	825/825 W	16/16 Ohms
00910-0126-0002	825/825 W	16/16 Ohms
00913-0072-0001	500/500 W	28/28 Ohms

To connect the heater perform the following steps after removing the top cover of the controller (four screws). Be sure the heater cable is adequate for the amount of current required and that the heater is wired correctly and safely.

1. The heater cable has 4 wires labeled C, D, E, and G. Determine whether the heater configuration uses **G** as a ground connection or **G** as one leg of the High heater by measuring the resistance from the spade connectors.
 - a) The **PRESENT** heater assembly configuration (Figure 2) uses **G** as a ground connection
 - b) The **OLD** heater assembly configuration (Figure 1) uses **G** as one leg of the High heater.

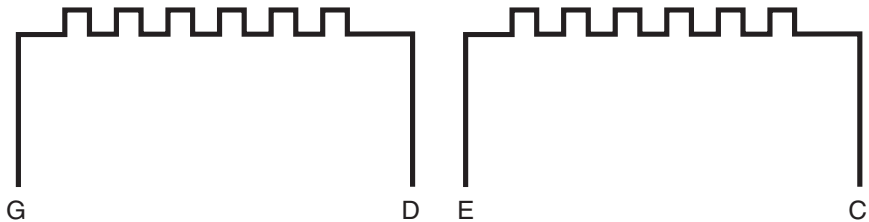

Figure 1 Old heater configuration

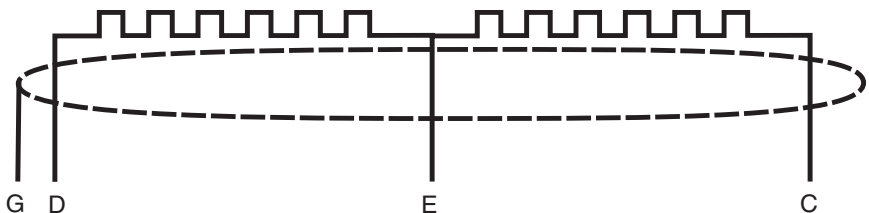

Figure 2 Present heater configuration

2. Feed the wires through the strain relief labeled “HEATER” and route them to the terminal block.
3. If you have the **PRESENT** heater assembly configuration (Figure 2), connect all the wires as labeled on the terminal block.
4. If you have the **OLD** heater assembly configuration (Figure 1), connect the D and G wires together into the terminal slot labeled D. Connect the rest of the wires as labeled. There is no direct ground connection through the heater wires. Instead the assembly will be grounded through the flow chute assembly.
5. The heater hookup is complete.

4.2.2.2 Stir Motor Connection

Connect the stirring device to the back of the controller through the strain relief labeled “STIR MOTOR”. Secure the stirrer to the terminal block at the terminals marked A, B, and G for the stirrer. See Figure 3.

4.2.2.3 LN₂ Connection

Connect the LN₂ cooling through the strain relief labeled “COOLING DEVICE”. Secure the LN₂ cooling to the terminal block at the terminals marked

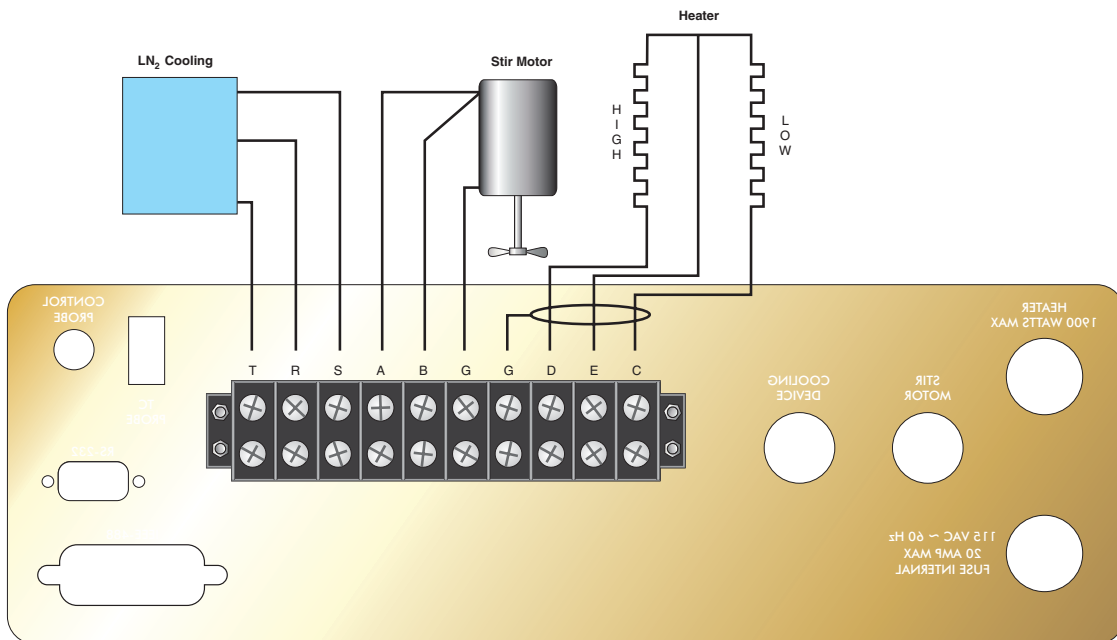

Figure 3 Terminal Block

R, S, and T for cooling. **DO NOT** attach mechanical cooling through the controller.



CAUTION: Be sure that the combined current of the heater, stirrer, and LN₂ cooling does not exceed 20 amps.

4.2.3 Control Probe

Connect the control probe into the socket at the back of the controller labeled "CONTROL PROBE" (see Figure 5). Insert the probe into the bath or system to be controlled. For best stability and response time the control probe should be located in close proximity to the heater. Observe the maximum temperature rating of the probe and be careful it is not exceeded.

4.2.4 Thermocouple Probe

Connect the thermocouple cut-out probe to the back of the controller to the connector labeled "TC PROBE". Insert the probe into the bath or system being controlled.

4.2.5 Power

Connect the controller power cord to a power source of the appropriate voltage and current rating (see Section 3.1, Specifications).

4.2.6 Fuses



CAUTION: Never use this instrument in a system that uses more power or current as listed in Section 3.1, Specifications.

The controller is shipped from the factory with fast acting fuses rated for the maximum capacity of the instrument.

If the controller is connected to a system which uses less than 10 amps, the fuses will need to be changed in order to be correct for the system. Once the controller is connected in the system, the system current needs to be measured or calculated and the appropriate fuse size and characteristics selected. Generally, the fuse selected is rated at 125% of the maximum current of the system. The time-current characteristics of the fuse are selected by the application. Usually, fast acting fuses are selected systems without a high in-rush current, i.e. "hot" calibration baths. Time-delay or slow blow fuses are selected for systems with a high in-rush current, i.e. "cold" calibration baths. Refer to the fuseology section of your fuse catalog for help in determining fuse size and characteristics or contact an Authorized Service Center (see Section 1.3) for assistance. Once the correct fuse characteristics and rating of the fuses have been selected and the appropriate fuses placed in the power entry module of the instrument, mark the instrument so the user can visibly see the fuse size and rat-

ing for fuse replacement. Be sure to change both fuses to the new rating and correct characteristic.

The controller uses 0.2 amps of current. This current should be taken into consideration when calculating the system power.

Example when using the power of the system:

P = Power of the system (Total Watts)

V = Nominal line voltage (115 VAC)

I = Fuse current

$$I = 1.25 \times \frac{P}{0.9 \times v}$$

Example when using the system current:

I = System current

I_F = Fuse current rating

$$I_F = 1.25 \times I$$

4.2.7 Power Cord

Once the correct fuse is selected, the proper power cord can be selected. The controller is shipped with a 20 Amp 125 VAC power cord to accommodate the maximum power rating. An extra power cord rated for 15 Amps 125 VAC is included. If the total system current is 12 Amps or less, the 20 Amp power cord may be replaced with the 15 Amp power cord. If the system current exceeds 12 amps using the 15 amp power cord, the recommendations of the National Electric Code (NEC) are exceeded. You must use the 20 amp power cord once the system current exceeds 12 amps.



WARNING: DO NOT USE THE 15 AMP POWER CORD UNDER ANY CIRCUMSTANCES IF THE SYSTEM CURRENT EXCEEDS 12 AMPS.

4.3 Setting the Temperature

In the following discussion and throughout this manual a solid box around the word SET, UP, DOWN or EXIT indicates the panel button to press while the dotted box indicates the display reading on the front panel. Explanation of the button function or display reading is written at the right.

To view or set the temperature set-point proceed as follows. The front panel LED display normally shows the actual process temperature.

Section 7.3 explains in detail how to set the temperature set-point on the controller using the front panel keys. The procedure is summarized here.

(1) Press “SET” twice to access the set-point value.

- (2) Press “UP” or “DOWN” to change the set-point value.
- (3) Press “SET” to accept the new set-point and to display the vernier value.
- (4) Press “EXIT” to return to the temperature display.

When the set-point temperature is changed the system heats or cools until the new set-point is reached. The over-temperature cut-out should be correctly set for added safety. See Section 7.10

To obtain optimum control stability adjust the proportional band as discussed in Section 7.9.

5 Parts and Controls

5.1 Front Panel

The following controls and indicators are present on the controller front panel (see Figure 4 below): (1) the digital LED display, (2) the control buttons, (3) the controller on/off power switch, (4) the control indicator light, (5) the heater select switch, and (6) the cooling power switch.

(1) The digital display is an important part of the temperature controller because it not only displays set and actual temperatures but also displays various functions, settings, and constants. The display shows temperatures in values according to the selected scale units °C or °F.

(2) The control buttons (SET, DOWN, UP, and EXIT) are used to set the temperature set-point, access and set other operating parameters, and access and set calibration parameters. A brief description of the button functions follows:

SET – Used to display the next parameter in a menu and to set parameters to the displayed value.

DOWN – Used to decrement the displayed value of parameters.

UP – Used to increment the displayed value.

EXIT – Used to exit from a menu. When EXIT is pressed any changes made to the displayed value will be ignored.

(3) The on/off switch controls power to the instrument. It powers the stirring motor, the controller/heater circuit, and LN₂ cooling.

(4) The control indicator is a two color light emitting diode. This indicator lets the user visually see the ratio of heating to cooling. When the indicator is red the heater is on. When the indicator is green the heater is off and the controller is cooling.

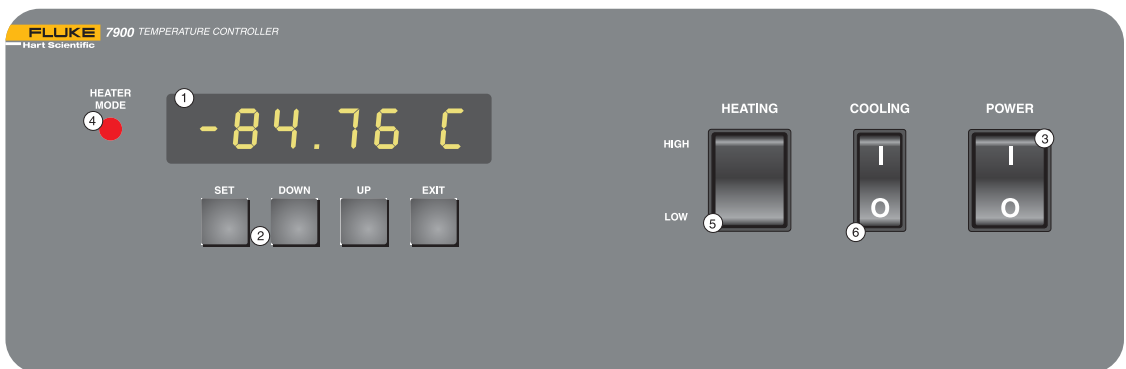

Figure 4 Front Control Panel

(5) The heater power is either automatic or user selected. The heater power switch is used to select the appropriate heater power levels for heating and controlling at various temperatures. Selecting “HIGH” heat manually overrides the automatic system.

(6) The cooling power switch controls power to the LN₂ cooling. Once the LN₂ cooling is energized, the flow is automatically controlled.

5.2 Back Panel

The following features are found on the back panel (see Figure 5) of the controller: (1) the cut-out thermocouple connector (TC), (2) the RS-232 interface connector, (3) the IEEE-488 (GPIB) interface connector, (4) the power cord, (5) the heater connector, (6) the stirrer motor connector, (7) the LN₂ cooling connector, and (8) the control probe connector.

- (1) The thermocouple cut-out probe senses the system temperature for the safety cut-out. When the temperature exceeds the cut-out set-point, opening a relay inside the controller disables the heater. The thermocouple probe is Type K.
- (2) The RS-232 communications cable is connected to this 9 pin DB sub-miniature connector. This enables the controller to be programmed and operated remotely.
- (3) The IEEE-488 (GPIB) interface connector is for remote computer control.
- (4) The power cord is rated at 115 VAC at 20 amps.



CAUTION: Do not draw more than 20 amps.
Note: The heater and system fuses are internal.



Figure 5 Back Panel

- (5) The heater connector is the source of controlled power for the system heater. This power is switched by the solid-state relay to maintain a constant temperature. To connect the heater, remove the top cover of the controller. The heater cable is fed through the strain relief in the back panel and the spade connectors are attached to the appropriate terminals on the internal terminal block. See Figure 3. The heater control for temperature range is automatic. The automatic system can be manually overridden by turning the heater power to high using the front panel switch.
- (6) The stirrer motor connector is an auxiliary power socket for the stirrer motor. This power is constant. The combined current of the heater, stirrer motor, and LN₂ cooling must not exceed 20 amps. The stirrer motor cable is fed through the strain relief in the back panel and the spade connectors are attached to the appropriate terminals on the terminal block inside the controller. See Figure 3.
- (7) The LN₂ cooling device connector is the source of controlled power for the system LN₂ cooling.



CAUTION: *The cooling power is for LN₂ cooling only. Do not use this connection for mechanical cooling.*

This power is switched by the solid-state relay. The LN₂ cooling alternates with the heater power to maintain a constant temperature. The LN₂ cooling cable is fed through the strain relief in the back panel and the spade connectors are attached to the appropriate terminals on the internal terminal block. See Figure 3.

- (8) The control probe connector for the system, attaches the 100Ω control RTD.

6 General Operation

6.1 Control System

The 7900 temperature controller is specified for use with the Rosemount designed calibration baths. The controller's flexibility enables it to be used with all Rosemount designed calibration bath systems.

It is the responsibility of the user to ensure that the components are chosen and the system constructed to ensure safe and proper operation of the complete system. The user should have a good knowledge of and experience with electrical fundamentals and wiring practices as well as control systems. Hart Scientific cannot be responsible for any damages or injuries resulting from improper design or operation of the control system. Technical support for setting up and operating a control system using the 7900 controller is available by telephone or fax from Hart Scientific. Be sure to read this 7900 user manual completely.

6.2 Power

Power to the controller is provided by an AC mains supply as specified in Section 3.1, Specifications. Power to the controller passes through an internal filter to prevent switching spikes from being transmitted to other equipment.

To turn on the controller switch the control panel power switch to the ON position. The LED display will begin to show the process temperature and the heater will turn on or off until the bath temperature reaches the programmed set-point.

When powered on the control panel display will briefly show a four digit number. This number indicates the number of times power has been applied to the controller. Also briefly displayed is data that indicates the controller hardware configuration. This data is used in some circumstances for diagnostic purposes.

6.3 Heater

The power to the heater plugged into the controller is precisely controlled to maintain a constant system temperature. Power is controlled by periodically switching the heater on for a certain amount of time using a solid-state relay.

The front panel red/green control indicator shows the state of the heater. The control indicator glows red when the heater is on and glows green when the heater is off. The indicator will pulse constantly when the controller is maintaining a stable temperature.

The heater power automatically switches between low and high when the bath is being heated to a new temperature. The automatic system can be overridden by turning the heater switch to "HIGH" power.

6.4 LN₂ Cooling

The power to the LN₂ cooling device plugged into the back of the controller is precisely controlled. Power is controlled by periodically switching the cooling on for a certain amount of time using a solid-state relay. The LN₂ cooling alternates with the heater power to maintain a constant temperature.

6.5 Temperature Controller

Hart Scientific's unique hybrid digital/analog temperature controller manipulates the system temperature. The controller offers the precise stability of an analog temperature controller as well as the flexibility and programmability of a digital controller.

The temperature is monitored with a platinum resistance sensor in the control probe. The signal is electronically compared with the programmable reference signal, amplified, and then passed to a pulse-width modulator circuit which controls the amount of power applied to the bath heater.

As a secondary protection device, the controller is also equipped with a separate thermocouple temperature monitoring circuit that shuts off the heater if the temperature exceeds the cut-out set-point.

The controller allows the operator to set the set-point temperature with high resolution, set the cut-out, adjust the proportional band, monitor the heater output power, and program the controller configuration and calibration parameters. The controller may be operated in temperature units of degrees Celsius or Fahrenheit. The controller is operated and programmed from the front control panel using the four key switches and digital LED display. The controller is equipped with an RS-232 serial and an IEEE-488 (GPIB) digital interface for remote operation. Operation of the controller using the front control panel is discussed in Section 8. Operation using the digital interface is discussed in Section 9.

When the controller is set to a new set-point the system heats or cools to the new temperature. Once the new temperature is reached it usually takes 10-15 minutes for the temperature to settle and stabilize. There may be a small overshoot or undershoot of about 0.5°C or more depending on the system and proportional band.

7 Controller Operation

This section discusses in detail how to operate the temperature controller using the front control panel. Using the front panel key switches and LED display the user may monitor the process temperature, set the temperature set-point in degrees C or F, monitor the heater output power, adjust the controller proportional band, set the cut-out set-point, and program the probe calibration parameters, operating parameters, serial and IEEE-488 interface configuration, and controller calibration parameters. Operations of the functions are shown in the flowchart summarized in Figure 6.

7.1 Process Temperature

The digital LED display on the front panel allows direct viewing of the process temperature. This temperature value is what is normally shown on the display. The units, C or F, of the temperature value are displayed at the right. For example,

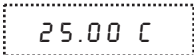
 *Process temperature in degrees Celsius*

The temperature display function may be accessed from any other function by pressing the “EXIT” button.

7.2 Reset Cut-out

If the over-temperature cut-out has been triggered then the temperature display will alternately flash,

 *Indicates cut-out condition*

The message will continue to flash until the temperature is reduced and the cut-out is reset. The cut-out has two modes, automatic reset and manual reset, and determines how the cut-out is reset. In automatic mode, the cut-out resets itself as soon as the temperature is lowered below the cut-out set-point. In manual reset mode, the operator must reset the cut-out after the temperature falls below the set-point. When the cut-out is active and the cut-out mode is set to manual (“r E S E T”), the display flashes “c u t - o u t” until the user resets the cut-out. To access the reset cut-out function press the “SET” button.

 *Access cut-out reset function*

The display indicates the reset function.

 *Cut-out reset function*

Press “SET” once more to reset the cut-out.

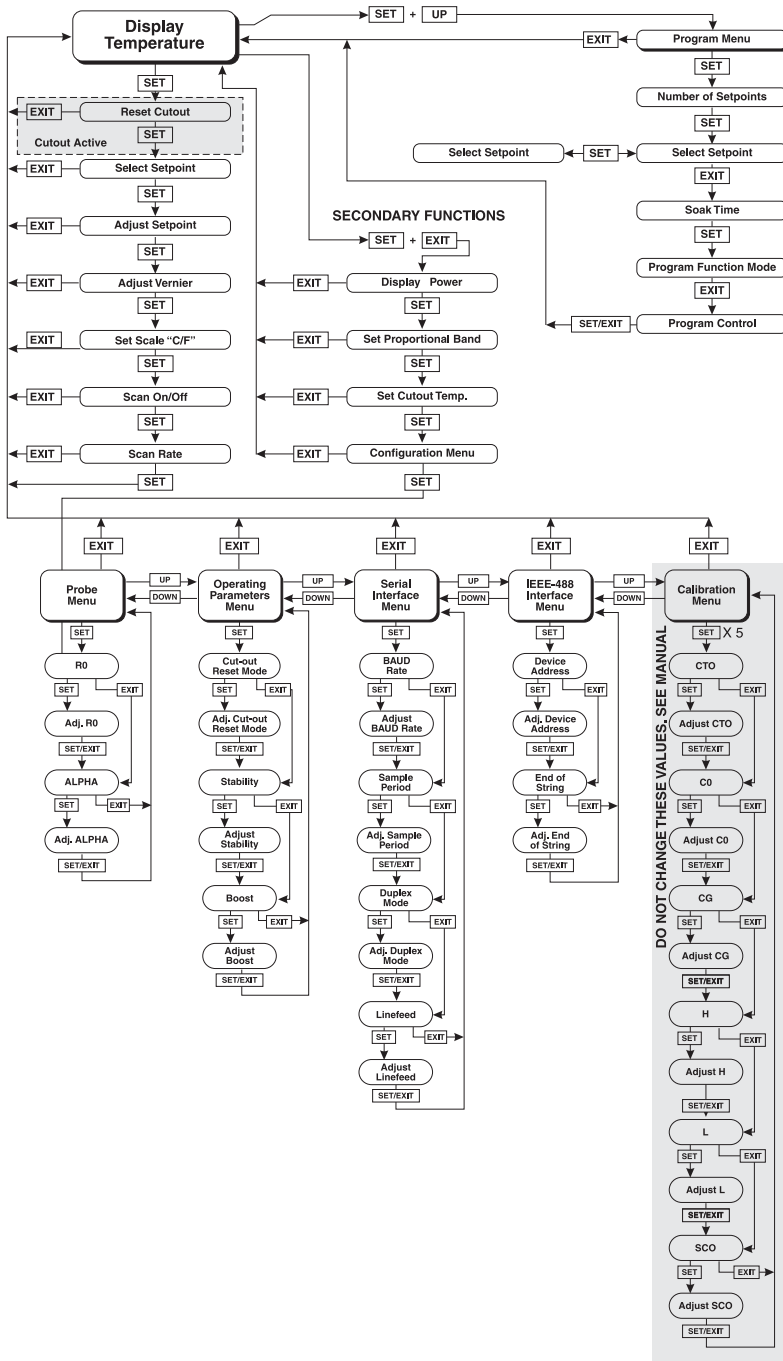

Figure 6 Controller Flow Chart



Reset cut-out

This action also switches the display to the set temperature function. To return to displaying the temperature, press the “EXIT” button. If the cut-out is still in the over-temperature fault condition the display will continue to flash “cut-out”. The bath temperature must drop a few degrees below the cut-out set-point before the cut-out can be reset.

7.3 Temperature Set-point

The temperature can be set to any value within the range given in the specifications. The operator must know the temperature range of the particular fluid used in the bath. The bath should only be operated well below the upper temperature limit of the liquid or device inserted into the liquid. **In addition, the cut-out temperature should also be set below the upper limit of the fluid.**

Setting the temperature involves three steps: (1) select the set-point memory, (2) adjust the set-point value, and (3) adjust the vernier, if desired.

7.3.1 Programmable Set-points

The controller stores 8 set-point temperatures in memory. The set-points can be quickly recalled to conveniently set the system to a previously programmed temperature. To set the temperature one must first select the set-point memory. This function is accessed from the temperature display function by pressing “SET”. The number of the set-point memory currently being used is shown at the left on the display followed by the current set-point value.

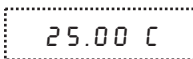

Process temperature in degrees Celsius



Access set-point memory

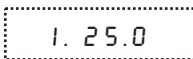

Set-point memory 1, 25.0°C currently used

To change the set-point memory press “UP” or “DOWN”.



Increment memory

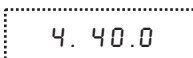

New set-point memory 4, 40.0°C

Press “SET” to accept the new selection and access the set-point value.



Accept selected set-point memory

7.3.2 Set-point Value

The set-point value may be adjusted after selecting the set-point memory and

pressing “SET”. The set-point value is displayed with the units, C or F, at the left.

 *Set-point 4 value in °C*

If the set-point value does not need to be changed then press “EXIT” to resume displaying the temperature. To adjust the set-point value press “UP” or “DOWN”.

 *Increment display*

 *New set-point value*

When the desired set-point value is reached press “SET” to accept the new value and access the set-point vernier. If “EXIT” is pressed any changes made to the set-point are ignored.

 *Accept new set-point value*

7.3.3 Set-point Vernier

The set-point value can be set with a resolution of 0.01°C. The user may want to adjust the set-point slightly to achieve a more precise temperature. The set-point vernier allows one to adjust the temperature below or above the set-point by a small amount with very high resolution. Each of the 8 stored set-points has an associated vernier setting. The vernier is accessed from the set-point by pressing “SET”. The vernier setting is displayed as a 6 digit number with five digits after the decimal point. This is a temperature offset in degrees of the selected units, C or F.

 *Current vernier value in °C*

To adjust the vernier press “UP” or “DOWN”. Unlike most functions the vernier setting has immediate effect as it is adjusted allowing the user to continually adjust the system temperature with the vernier as the temperature is displayed. “SET” does not need to be pressed.

 *Increment display*

 *New vernier setting*

Next press “EXIT” to return to the temperature display or “SET” to access the temperature scale units selection.

 *Access scale units*

7.4 Temperature Scale Unit

The user may set the temperature scale units of the controller to degrees Celsius (°C) or Fahrenheit (°F). The units are used in displaying the process temperature, set-point, vernier, proportional band, and cut-out set-point.

The temperature scale units selection is accessed after the vernier adjustment function by pressing “SET”. From the temperature display function access the units selection by pressing “SET” 4 times.

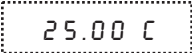
 *Process temperature*

 *Access set-point memory*

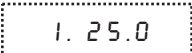
 *Set-point memory*

 *Access set-point value*

 *Set-point value*

 *Access vernier*

 *Vernier setting*

 *Access scale units selection*

 *Scale units currently selected*

Press “UP” or “DOWN” to change the units.

 *Change units*

 *New units selected*

Press “SET” to accept the new selection and resume displaying the bath temperature.

 *Set the new units and resume temperature display*

7.5 Scan

The scan control can be turned on or off and the scan rate can be set and enabled so that when the set-point is changed the controller heats or cools at a specified rate (degrees per minute) until the new set-point is reached. With the

scan disabled the controller heats or cools at the maximum possible rate.

7.5.1 Scan Control

The scan is controlled with the scan on/off function that appears in the main menu after the set-point function.

 *Scan function off*

Press “UP” or “DOWN” to toggle the scan on or off.

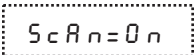
 *Scan function on*

Press “SET” to accept the present setting and continue.

 *Accept scan setting*

7.5.2 Scan Rate

The next function in the main menu is the scan rate. The scan rate can be set from .1 to 100 °C/min. The maximum scan rate, however, is actually limited by the natural heating or cooling rate of the instrument which is often less than 100 °C/min, especially when cooling. The scan rate function appears in the main menu after the scan control function. The scan rate units are in degrees per minute, degrees C or F depending on the selected units.

 *Scan rate in °C/min*

Press “UP” or “DOWN” to change the scan rate.

 *New scan rate*

Press “SET” to accept the new scan rate and continue.

 *Accept scan rate*

7.6 Ramp and Soak Program

The ramp and soak program feature allows the user to program a number of set-points and have the controller automatically cycle between the temperatures, holding at each for a determined length of time. The user can select one of four different cycle functions.

The program parameter menu is accessed by pressing “SET” and then “UP”.

 *Well temperature*

 +  *Access program menu*

P r o G *Program menu*

Press “SET” to enter the program menu

SET *Enter program menu*

7.6.1 Number of Program Set-points

The first parameter in the program menu is the number of set-points to cycle through. Up to 8 set-points can be used in a ramp and soak program.

P n = 8 *Number of program set-points*

Use the “UP” or “DOWN” buttons to change the number from 2 to 8.

P n = 3 *New number of program set-points*

Press “SET” to continue. Press “EXIT” to ignore any changes made to the parameter.

SET *Save new setting*

7.6.2 Set-points

The next parameters are the program set-points.

1 50.0 *First set-point*

Use the “UP” or “DOWN” buttons to select any of the set-points.

3 150.0 *Third set-point*

Press “SET” to be able to change the set-point.

⌈ 150.00 *Set-point value*

Use “UP” and “DOWN” to change the set-point value.

⌈ 165.00 *New set-point value*

Press “SET” to save the new set-point value. The other set-points can also be set in the same manner. Once the set-points are programmed as desired press “EXIT” to continue.

EXIT *Continue to next menu function*

7.6.3 Program Soak Time

The next parameter in the program menu is the soak time. This time, in minutes, is the time each program set-point waits after settling before proceeding to the next set-point. The duration is counted from the time the temperature settles to within a specified stability. The stability requirement can be set in the parameter menu as explained in Section 6.13.4. The default is 0.1°C.

 *Soak time in minutes*

Use the “UP” or “DOWN” buttons to change the time.

 *New soak time*

Press “SET” to continue.

 *Save new setting*

7.6.4 Program Function Mode

The next parameter is the program function or cycle mode. There are four possible modes that determine whether the program scans up (from set-point 1 to n) only or both up and down (from set-point n to 1), and also whether the program stops after one cycle or repeats the cycle indefinitely. Table 3 below shows the action of each of the four program mode settings.

 *Program mode*

Use the “UP” or “DOWN” buttons to change the mode.

 *New mode*

Press “SET” to continue.

Table 2 Program mode setting actions

Function	Action
1	Up-Stop
2	Up-Down-Stop
3	Up-Repeat
4	Up-Down-Repeat

 *Save new setting*

7.6.5 Program Control

The final parameter in the program menu is the control parameter. You may choose between three options to either start the program from the beginning, continue the program from where it was when it was stopped, or stop the program.

`P r = O F F` *Program presently off*

Use the “UP” or “DOWN” buttons to change the status.

`P r = S t A r t` *Start cycle from beginning*

Press “SET” to activate the new program control command and return to the temperature display.

 *Activate new command.*

7.7 Secondary Menu

Functions, which are used less often, are accessed within the secondary menu. Pressing “SET” and “EXIT” simultaneously and then releasing accesses the secondary menu. The first function in the secondary menu is the heater power display. (See Figure 6 on page 24.)

7.8 Heater Power

The temperature controller controls the temperature of the well by pulsing the heater on and off. The duty cycle or the ratio of heater on time to the pulse cycle time determines the total power being applied to the heater. This value may be estimated by watching the red/green control indicator light or may be read directly from the digital display. By knowing the amount of heating the user can tell if the system is heating up to the set-point, cooling down, or controlling at a constant temperature. Monitoring the percent heater power lets the user know how stable the well temperature is. With good control stability the percent heating power should not fluctuate more than $\pm 5\%$ within one minute.

The heater power display is accessed in the secondary menu. Press “SET” and “EXIT” simultaneously and release. The heater power is displayed as a percentage of full power.

 +  *Access heater power in secondary menu*

`100 P c t` *Heater power in percent*

To exit out of the secondary menu press “EXIT”. To continue on to the proportional band setting function press “SET”.

7.9 Proportional Band

In a proportional controller such as this the heater output power is proportional to the well temperature over a limited range of temperatures around the set-point. This range of temperature is called proportional band. At the bottom of the proportional band the heater output is 100%. At the top of the proportional band the heater output is 0%. Thus as the temperature rises the heater power is reduced, which consequently tends to lower the temperature back down. In this way the temperature is maintained at a fairly constant value.

The temperature stability of the well and response time depend on the width of the proportional band. See Figure 7. If the band is too wide the well temperature deviates excessively from the set-point due to varying external conditions. This deviation is because the power output changes very little with temperature and the controller cannot respond very well to changing conditions or noise in the system. If the proportional band is too narrow the temperature may swing back and forth because the controller overreacts to temperature variations. Best stability control is only possible when the proportional band is set for the optimum width for the specific system configuration.

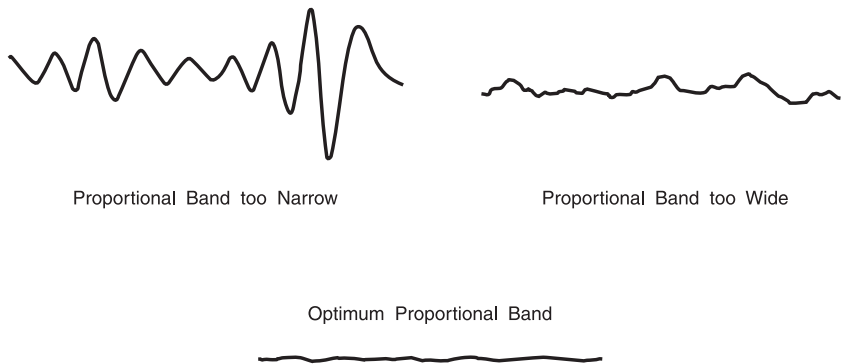

Figure 7 Temperature fluctuations at various proportional band settings

The optimum proportional band width depends on several factors including system heat transfer characteristics and heater-probe positioning. Thus the proportional band width may require adjustment for best bath stability when any of these conditions change.

The proportional band width is easily adjusted from the front panel. The width may be set to discrete values in degrees C or F depending on the selected units. The optimum proportional bandwidth setting may be determined by monitoring the stability with a high resolution thermometer or with the controller percent output power display. Narrow the proportional bandwidth to the point at which the process temperature begins to oscillate. Increase the bandwidth from this point by multiplying the current value by 3 and entering this new value.

The integral time of the controller is determined by component selection and cannot be set by the user. This value is fixed at approximately 300 seconds.

The proportional band adjustment can be accessed within the secondary menu. Press “SET” and “EXIT” to enter the secondary menu and show the heater power. Then press “SET” twice to access the proportional band.

 +  *Access heater power in secondary menu*

 *Heater power in percent*

 *Access set-point voltage*

 *Proportional band setting*

To change the proportional band press “UP” and “DOWN”.

 *Decrement display*

 *New proportional band setting*

To store the new setting and access the cut-out set-point press “SET”. Press “EXIT” to exit out of the secondary menu.

 *Accept the new proportional band setting*

7.10 Cutout

As a protection against software or hardware fault, shorted heater triac, or user error, the controller is equipped with an adjustable heater cutout device that shuts power off to the heater if the system temperature exceeds a set value. This protects the heater and system materials from excessive temperatures. The cut-out temperature is programmable by the operator from the front panel of the controller. The cutout temperature must always be set below the upper temperature limit of the bath fluid.

If the cutout is activated because of excessive temperature, power to the heater shuts off and the system cools. The system cools until it reaches a few degrees below the cutout set-point temperature. At this point the action of the cutout is determined by the setting of the cutout mode parameter. The cutout has two modes — automatic reset or manual reset. If the mode is set to automatic, the cutout automatically resets when the system temperature falls below the reset temperature allowing the system to heat up again. If the mode is set to manual, the heater remains disabled until the user manually resets the cutout.

The cutout set-point may be accessed within the secondary menu. Press “SET” and “EXIT” to enter the secondary menu and show the heater power. Then press “SET” twice to access the cutout set-point.

 +  *Access heater power in secondary menu*

 *Heater power in percent*

 *Access proportional band*

 *Proportional band setting*

 *Access cutout set-point*

 *Cutout set-point*

To change the cutout set-point press “UP” or “DOWN”.

 *Decrement display*

 *New cutout set-point*

To accept the new cutout set-point press “SET”.

 *Accept cutout set-point*

The next function is the configuration menu. Press “EXIT” to resume displaying the temperature.

7.11 Controller Configuration

The controller has a number of configuration and operating options and calibration parameters that are programmable via the front panel. These are accessed from the secondary menu after the proportional band function by pressing “SET”. The display prompts with “ConFIG”. Press “SET” again to enter the first of five groups of configuration parameters—probe parameters, operating parameters, serial interface parameters, IEEE parameters, and calibration parameters. The groups are selected using the “UP” and “DOWN” keys and then pressing “SET”. (See Figure 6 on page 24)

7.12 Probe Parameters RTD Sensor

The probe parameter menu is indicated by,

 *Probe parameters menu*

Press “SET” to enter the menu. The probe parameters menu contains the parameters, R_0 and ALPHA, which characterize the resistance-temperature relationship of the platinum control probe. These parameters may be adjusted to

improve the accuracy of the bath. This procedure is explained in detail in Section 9.

The probe parameters are accessed by pressing “SET” after the name of the parameter is displayed. The value of the parameter may be changed using the “UP” and “DOWN” buttons. After the desired value is reached press “SET” to set the parameter to the new value. Pressing “EXIT” causes the parameter to be skipped ignoring any changes that may have been made.

7.12.1 **R₀**

This probe parameter refers to the resistance of the control probe at 0°C. Normally this is set for 100.000 ohms.

7.12.2 **ALPHA**

This probe parameter refers to the average sensitivity of the probe between 0 and 100°C. Normally this is set for 0.00385°C.

7.13 **Operating Parameters**

The operating parameters menu is indicated by,

P P r *Operating parameters menu*

Press “SET” to enter the menu. The operating parameters menu contains the cutout reset mode and soak stability.

7.13.1 **Cutout Reset Mode**

The cutout reset mode determines whether the cutout resets automatically when the system temperature drops to a safe value or must be manually reset by the operator.

The parameter is indicated by,

C t o r S t *Cutout reset mode parameter*

Press “SET” to access the parameter setting. Normally the cutout is set for manual mode.

C t o = r S t *Cutout set for manual reset*

To change to automatic reset mode press “UP” and then “SET”.

C t o = A u t o *Cutout set for automatic reset*

7.13.2 Soak Stability

The soak stability controls the required stability of the well temperature. The stability is in degrees Celsius. The default is 0.1°C.

This parameter is indicated by,

Soak stability parameter

Press "SET" to access the parameter setting.

Soak stability set for 0.50°C

To change the parameter setting, press "UP" or "DOWN" and then "SET" to store the value.

7.13.3 Boost Temperature Offset

The boost temperature offset allows the user to select the boost value (Δt) at which the boost heat turns off. The boost heat switches off if the temperature is within the boost value (Δt) of the set-point. The boost heat switches on if the temperature falls below the set-point by the boost value of plus 0.1°C. The boost value is always in degrees C even if the unit is set to degrees F.

This parameter is indicated by,

Boost temperature offset

Press "SET" to access the parameter setting.

Boost temperature offset set for 4.0°C

To change the parameter setting, press "UP" or "DOWN" and then "SET" to store the value.

7.14 Serial Interface Parameters

The serial RS-232 interface parameters menu is indicated by,

Serial RS-232 interface parameters menu

The serial interface parameters menu contains parameters which determine the operation of the serial interface. The parameters in the menu are: baud rate, sample period, duplex mode, and linefeed.

7.14.1 Baud Rate

The baud rate is the first parameter in the menu. The baud rate setting determines the serial communications transmission rate.

The baud rate parameter is indicated by,

`BAUD` *Serial baud rate parameter*

Press “SET” to choose to set the baud rate. The current baud rate value is then displayed.

`2400` *Current baud rate*

The baud rate of the serial communications may be programmed to 300 600, 1200, or 2400 baud. 2400 baud is the default setting. Use “UP” or “DOWN” to change the baud rate value.

`4800 b` *New baud rate*

Press “SET” to set the baud rate to the new value or “EXIT” to abort the operation and skip to the next parameter in the menu.

7.14.2 Sample Period

The sample period is the next parameter in the serial interface parameter menu. The sample period is the time period in seconds between temperature measurements transmitted from the serial interface. If the sample rate is set to 5, the instrument transmits the current measurement over the serial interface approximately every five seconds. The automatic sampling is disabled with a sample period of 0. The sample period is indicated by,

`SAMPLE` *Serial sample period parameter*

Press “SET” to choose the sample period. The current sample period value is displayed.

`SA=1` *Current sample period (seconds)*

Adjust the value with “UP” or “DOWN” and then use “SET” to set the sample rate to the displayed value. “EXIT” does not store the new value.

`SA=50` *New sample period*

7.14.3 Duplex Mode

The next parameter is the duplex mode. The duplex mode may be set to full duplex or half duplex. With full duplex any commands received by the controller via the serial interface are immediately echoed or transmitted back to the device of origin. With half duplex the commands are executed but not echoed. The duplex mode parameter is indicated by,

`d U P L` *Serial duplex mode parameter*

Press “SET” to access the mode setting.

`d U P = F U L L` *Current duplex mode setting*

The mode may be changed using “UP” or “DOWN” and pressing “SET”.

`d U P = H R L F` *New duplex mode setting*

7.14.4 Linefeed

The final parameter in the serial interface menu is the linefeed mode. This parameter enables (on) or disables (off) transmission of a linefeed character (LF, ASCII 10) after transmission of any carriage-return. The linefeed parameter is indicated by,

`L F` *Serial linefeed parameter*

Press “SET” to access the linefeed parameter.

`L F = O n` *Current linefeed setting*

The mode may be changed using “UP” or “DOWN” and pressing “SET”.

`L F = O F F` *New linefeed setting*

7.15 IEEE-488 Parameters

With an IEEE-488 GPIB interface the user may set the IEEE-488 interface address and the transmission termination character within the IEEE-488 parameter menu. The menu is indicated by,

`I E E E` *IEEE-488 parameters menu*

Press “SET” to enter the menu.

7.15.1 IEEE-488 Address

The IEEE-488 interface must be configured to use the same address as the external communicating device. The address is indicated by,

`A d d r E S S` *IEEE-488 interface address*

Press “SET” to access the address setting.

`Addr= 22` *Current IEEE-488 interface address*

Adjust the value with “UP” or “DOWN” and then use “SET” to set the address to the displayed value.

`Addr= 15` *New IEEE-488 interface address*

7.15.2 Termination

The transmission termination character can be set to carriage return only, linefeed only, or carriage return and linefeed. Regardless of the option selected the controller interprets either a carriage return or a linefeed as a command termination during reception. The termination parameter is indicated with,

`EOS` *IEEE-488 termination*

Press “SET” to access the termination setting.

`EOS=Cr` *Present IEEE-488 termination*

Use “UP” or “DOWN” to change the selection.

`EOS=LF` *New termination selection*

Use “SET” to save the new selection.

7.16 Calibration Parameters

The operator of the controller has access to a number of the calibration and setup constants, namely CTO, C0, CG, H, L, and SCO. The calibration values are set at the factory and must not be altered. The correct values are important to the accuracy of the controller. Access to these parameters is available to the user only so that in the event that the controller’s memory fails the user may restore these values to the factory settings. The user should have a list of these constants and their settings with the manual.



WARNING: DO NOT change the values of the controller constants from the factory set values. The correct setting of these parameters is important to the safety and proper operation of the system.

The calibration parameters menu is indicated by,

`CL` *Calibration parameters menu*

Press “SET” five times to enter the menu.

7.16.1 CTO

Parameter CTO sets the calibration of the over-temperature cutout. This parameter is not adjustable by software but is adjusted with an internal potentiometer.

7.16.2 CO and CG

These parameters calibrate the accuracy of the controller set-point. These are programmed at the factory when the controller is calibrated. Do not alter the value of these parameters. If the user desires to calibrate the controller for improved accuracy then calibrate R_0 and ALPHA according to the procedure given in Section 9.

7.16.3 H and L

These parameters set the upper and lower set-point limits of the controller. These parameters should not be set beyond the safe operating temperature limits of the system.

7.16.4 SCO

This parameter is used at the factory for testing purposes and **SHOULD NOT** be altered by the user.

8 Digital Communication Interface

The 7900 controller is capable of communicating with and being controlled by other equipment through the digital serial interface. The RS-232 serial interface and IEEE-488 (GPIB) are standard.

With a digital interface the controller may be connected to a computer or other equipment. This connection allows the user to set the set-point temperature, monitor the temperature, and access any of the other controller functions, all using remote communications equipment. Communications commands are summarized in Table 3 on page 45.

Hart Scientific recommends the use of shielded RS-232 and IEEE-488 (GPIB) cables for all remote communication.

8.1 Serial Communications

The controller comes installed with an RS-232 serial interface that allows serial digital communications over fairly long distances. With the serial interface the user may access any of the functions, parameters and settings discussed in Section 8 with the exception of the BAUD rate setting. The serial interface operates with 8 data bits, 1 stop bit, and no parity.

RS-232 Cable Wiring for IBM PC and Compatibles

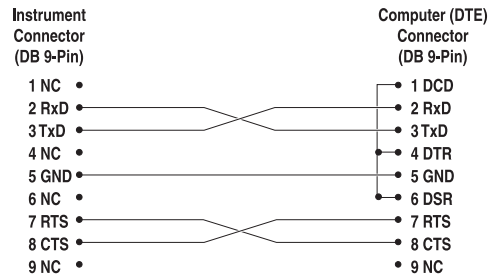

8.1.1 Wiring

The serial communications cable attaches to the controller through the DB-9 connector at the back panel. Figure 8 shows the pin-out of this connector and suggested cable wiring. To eliminate noise the serial cable should be shielded with low resistance between the connector (DB-9) and the shield.

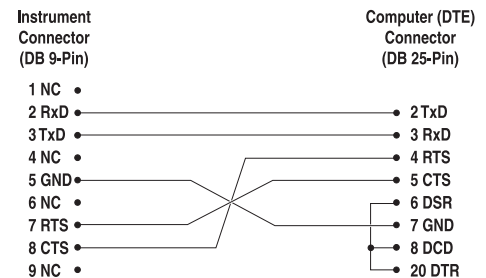

Figure 8 Serial Communications Cable Wiring

8.1.2 Setup

Before operation the serial interface must first be set up by programming the BAUD rate

and other configuration parameters. These parameters are programmed within the serial interface menu.

To enter the serial parameter programming mode first press “EXIT” while pressing “SET” and release to enter the secondary menu. Press “SET” repeatedly until the display reads “P A R”. Press “UP” until the serial interface menu is indicated with “S E R I A L”. Finally press “SET” to enter the serial parameters menu. In the serial interface parameters menu are the BAUD rate, the sample rate, the duplex mode, and the linefeed parameter.

8.1.2.1 Baud Rate

The baud rate is the first parameter in the menu. The display prompts with the baud rate parameter by showing “b A U D”. Press “SET” to choose to set the baud rate. The current baud rate value is displayed. The baud rate of the serial communications may be programmed to 300, 600, 1200, 2400, 4800, or 9600 baud. The baud rate is pre-programmed to 2400 baud. Use “UP” or “DOWN” to change the baud rate value. Press “SET” to set the BAUD rate to the new value or “EXIT” to abort the operation and skip to the next parameter in the menu.

8.1.2.2 Sample Period

The sample period is the next parameter in the menu and prompted with “S A M P L E”. The sample period is the time period in seconds between temperature measurements transmitted from the serial interface. If the sample rate is set to 5, the instrument transmits the current measurement over the serial interface approximately every five seconds. The automatic sampling is disabled with a sample period of 0. Press “SET” to choose to set the sample period. Adjust the period with “UP” or “DOWN” and then use “SET” to set the sample rate to the displayed value.

8.1.2.3 Duplex Mode

The next parameter is the duplex mode indicated with “d U P L”. The duplex mode may be set to half duplex (“H A L F”) or full duplex (“F U L L”). With full duplex any commands received by the instrument via the serial interface are immediately echoed or transmitted back to the device of origin. With half duplex the commands are executed but not echoed. The default setting is full duplex. The mode may be changed using “UP” or “DOWN” and pressing “SET”.

8.1.2.4 Linefeed

The final parameter in the serial interface menu is the linefeed mode. This parameter enables (“O N”) or disables (“O F F”) transmission of a linefeed character (LF, ASCII 10) after transmission of any carriage-return. The default setting is with linefeed on. The mode may be changed using “UP” or “DOWN” and pressing “SET”.

8.1.3 Serial Operation

Once the cable has been attached and the interface set up properly the controller immediately begins transmitting temperature readings at the programmed rate. The serial communications uses 8 data bits, one stop bit, and no parity. The set-point and other commands may be sent via the serial interface to set the temperature set-point and view or program the various parameters. The interface commands are discussed in Section 9.2. All commands are ASCII character strings terminated with a carriage-return character (CR, ASCII 13).

8.1.4 IEEE-488 Communication

The IEEE-488 interface is a GPIB type communication bus that allows many instruments to be connected and controlled simultaneously. To eliminate noise, the GPIB cable should be shielded.

8.1.4.1 Setup and Address Selection

To use the IEEE-488 interface first connect an IEEE-488 standard cable to the back of the controller.

Next set the device address. This parameter is programmed within the IEEE-488 interface menu. To enter the IEEE-488 parameter programming menu first press "EXIT" while pressing "SET" and release to enter the secondary menu. Press "SET" repeatedly until the display reaches "P r O b E". This is the menu selection. Press "UP" repeatedly until the IEEE-488 interface menu is indicated with "IEEE". Press "SET" to enter the IEEE-488 parameter menu. The IEEE-488 menu contains the IEEE-488 address parameter.

The IEEE-488 address is prompted with "A d d r E S S". Press "SET" to program the address. The default address is 22. Change the device address if necessary to match the address used by the communication equipment by pressing "UP" or "DOWN" and then "SET".

8.1.4.2 IEEE-488 Operation

Commands may now be sent via the IEEE-488 interface to read or set the temperature or access other controller functions. All commands are ASCII character strings and are terminated with a carriage-return (CR, ASCII 13). Interface commands are listed below.

8.2 Interface Commands

The various commands for accessing the controller functions via the digital interfaces are listed in this section (see Table 3). These commands are used with both the RS-232 serial interface and the IEEE-488 GPIB interface. In either case the commands are terminated with a carriage-return character. The interface makes no distinction between upper and lower case letters, hence either may be used. Commands may be abbreviated to the minimum number of letters that determines a unique command. A command may be used to either set a pa-

parameter or display a parameter depending on whether or not a value is sent with the command following a “=” character. For example “s” will return the current set-point and “s=150.0” will set the set-point to 150.0 degrees.

In the following list of commands, characters or data within brackets, “[” and “]”, are optional for the command. A slash, “/”, denotes alternate characters or data. Numeric data, denoted by “n”, may be entered in decimal or exponential notation. Characters are shown in lower case although upper case may be used. Spaces may be added within command strings and will simply be ignored. Backspace (BS, ASCII 8) may be used to erase the previous character. A terminating CR is implied with all commands.

8.3 Power Control Functions

The digital interface is capable of controlling the heating and cooling functions so that the controller can be remotely operated at any temperature within the range of the bath. To allow the interface to control the heating and cooling, the front panel controls are disabled by switching the heater switch to LOW and the cooling switch to OFF. Otherwise, the interface would not be able to switch these functions off. The 7900 controller has 2 control functions with the digital interface. These are heater power high/low and cooling on/off. See Table 6.

8.3.1 Heater Control

The 7900 controller automatically switches to high heat whenever the set-point is 3°C higher than the actual temperature. To override this function so that the heaters stay on high heat for higher temperatures, use the F1 command.

To control the heater with the digital interface the front panel heater switch must be set to LOW. The heater function is controlled with the “F1” command. Setting the “F1” parameter to “0” sets the heater to LOW and setting the parameter to “1” sets the heater to HIGH. Sending “F1” with no value returns the current state of the heater control. When the heater setting is changed, the heater relay can be heard as it opens or closes.

8.3.2 Cooling Control

To enable the cooling device with the digital interface the cooling switch on the front panel must be off. The cooling power function is controlled with the “F2” command. Setting the “F2” parameter to “0” turns the cooling off and setting

Table 3 Serial Interface Commands

Command Description	Command Format	Command Example	Returned	Returned Example	Acceptable Values
Display Temperature					
Read current set-point	s[etpoint]	s	set: 9999.99 {C or F}	set: 150.00 C	
Set current set-point to <i>n</i>	s[etpoint]= <i>n</i>	s=450			Instrument Range
Read vernier	v[ernier]	v	v:9.99999	v:0.00000	
Set vernier	v[ernier]= <i>n</i>	v=0.0001			Depends on configuration
Set temperature units:	u[nits]=c/f				C or F
Set temperature units to Celsius	u[nits]=c	u=c			
Set temperature units to Fahrenheit	u[nits]=f	u=f			
Read scan function	sc[an]	sc	scan: {ON or OFF}	scan: ON	
Set scan function:	sc[an]=on/off				ON or OFF
Turn scan function on	sc[an]=on	sc=on			
Turn scan function off	sc[an]=off	sc=of			
Read scan rate	sr[ate]	sr	srat: 999.99 {C or F}/min	srat: 10.0 C/min	
Set scan rate to <i>n</i> degrees per minute	sr[ate]= <i>n</i>	sr=5			.1 to 100°C
Read temperature	t[emperature]	t	t: 9999.99 {C or F}	t: 55.69 C	
Read temperature units	u	u	u:x	u:c	
Secondary Menu					
Read proportional band setting	pr[op-band]	pr	pb: 999.9	pb: 15.9	
Set proportional band to <i>n</i>	pr[op-band]= <i>n</i>	pr=8.83			Depends on Configuration
Read cutout setting	c[utout]	c	c: 9999 {C or F}	c: 620 C	
Set cutout setting:	c[utout]=<i>n</i>/<i>r</i>[eset]				
Set cutout to <i>n</i> degrees	c[utout]= <i>n</i>	c=500			Temperature Range
Reset cutout now	c[utout]= <i>r</i> [eset]	c= <i>r</i>			
Read heater power (duty cycle)	po[wer]	po	p%: 9999	po: 1	
Ramp and Soak Menu					
Read number of programmable set-points	pn	pn	pn: 9	pn: 2	
Set number of programmable set-points to <i>n</i>	pn= <i>n</i>	pn=4			1 to 8
Read programmable set-point number <i>n</i>	ps <i>n</i>	ps3	ps <i>n</i> : 9999.99 {C or F}	ps1: 50.00 C	

Table 4 Serial Interface Commands continued

Command Description	Command Format	Command Example	Returned	Returned Example	Acceptable Values
Set programmable set-point number <i>n</i> to <i>n</i>	ps <i>n</i> = <i>n</i>	ps3=50			1 to 8, Instrument Range
Read program set-point soak time	pt	pt	ti: 999	ti: 5	
Set program set-point soak time to <i>n</i> minutes	pt= <i>n</i>	pt=5			0 to 500
Read program control mode	pc	pc	prog: {OFF or ON}	prog: OFF	
Set program control mode:	pc=g[o]/s[top]/c[ont]				GO or STOP or CONT
Start program	Pc=g[o] or pc=[on]	pc=g			
Stop program	pc=s[top]	pc=s			
Continue program	pc=c[ont]	pc=c			
Read program function	pf	pf	pf: 9	pf: 3	
Set program function to <i>n</i>	pf= <i>n</i>	pf=2			1 to 4
Configuration Menu					
Probe Menu					
Read R0 calibration parameter	r[0]	r	r0: 999.999	r0: 100.578	
Set R0 calibration parameter to <i>n</i>	r[0]= <i>n</i>	r=100.324			98.0 to 104.9
Read ALPHA calibration parameter	al[pha]	al	al: 9.9999999	al: 0.0038573	
Set ALPHA calibration parameter to <i>n</i>	al[pha]= <i>n</i>	al=0.0038433			.00370 to .00399
Operating Parameters Menu					
Read cutout mode	cm[ode]	cm	m: {xxxx}	m: AUTO	
Set cutout mode:	cm[ode]=r[eset]/a[uto]				RESET or AUTO
Set cutout to be reset manually	cm[ode]=r[eset]	cm=r			
Set cutout to be reset automatically	cm[ode]=a[uto]	cm=a			
Read stability	ts	ts	ts:9.9	ts:0.5	
Set soak stability to <i>n</i> degrees	ts= <i>n</i>	ts=.1			.01 to 4.99°C
Read boost temperature offset	bt	bt	bt:9.99	bt:4.0	
Set boost temperature offset	bt= <i>n</i>	bt=9			0 to 9.99
Serial Interface Menu					
Read serial sample setting	sa[mple]	sa	sa: 9	sa: 1	
Set serial sampling setting to <i>n</i> seconds	sa[mple]= <i>n</i>	sa=0			0 to 4000
Set serial duplex mode:	du[plex]=f[ull]/h[alf]				FULL or HALF

Table 5 Serial Interface Commands continued

Command Description	Command Format	Command Example	Returned	Returned Example	Acceptable Values
Set serial duplex mode to full	du[plex]=f[ull]	du=f			
Set serial duplex mode to half	du[plex]=h[alf]	du=h			
Set serial linefeed mode:	lf[eed]=on/off[f]				ON or OFF
Set serial linefeed mode to on	lf[eed]=on	lf=on			
Set serial linefeed mode to off	lf[eed]=off[f]	lf=of			
Calibration Menu (WARNING – changing the following calibration values may change the accuracy of the instrument.)					
Read C0 calibration parameter	*c0	*c0	c0: 9	c0: 0	
Set C0 calibration parameter to <i>n</i>	*c0= <i>n</i>	*c0=0			–999.9 to 999.9
Read CG calibration parameter	*cg	*cg	cg: 999.99	cg: 406.25	
Set CG calibration parameter to <i>n</i>	*cg= <i>n</i>	*cg=406.25			–999.9 to 999.9
Read low set-point limit	*tl[ow]	*tl	tl:999	tl:–80	
Set low set-point limit to <i>n</i>	*tl[ow]= <i>n</i>	*tl=80			–999.9 to 999.9
Read high set-point limit	*th[igh]	*th	th:999	th:205	
Set high set-point limit to <i>n</i>	*th[igh]= <i>n</i>	*th=205			–999.9 to 999.9
Miscellaneous (not on menus)					
Read heater control function f1	f1	f1	f1:{low or high}	f1:low	
Set heater control function:					low or high
Set heater control to low	f1=low	f1=low			
Set heater control to high	f1=h[igh]	f1=high			
Read cooling control function f2	f2	f2	f2: {on or off}	f2: on	
Set cooling control function:					on or off
Set cooling control on	f2=on	f2=on			
Set cooling control off	f2=o[ff]	f2=off			
Read firmware version number	*ver[sion]	*ver	ver.9999,9.99	ver.7900,1.00	
Read structure of all commands	h[elp]	h	list of commands		
Read all extended operating parameters	*all	*all	list of commands		
Legend:	<p>[] Optional Command data</p> <p>/ Alternate characters or data</p> <p>{ } Returns either information</p> <p><i>n</i> Numeric data supplied by user—may be entered in decimal or exponential notation</p> <p>9 Numeric data returned to user</p> <p><i>x</i> Character data returned to user</p>				
Note:	When DUPLEX is set to FULL and a command is sent to READ, the command is returned followed by a carriage return and linefeed. Then the value is returned as indicated in the RETURNED column.				

the parameter to "1" turns the cooling on. "F2" with no value returns the current state of the cooling power control.

Table 6 *Power Control Functions*

Function	Command	0	1
High Heat	F1	low	high
Cooling	F2	off	on

9 Calibration Procedure

In some instances the user may want to calibrate the controller to improve the temperature set-point accuracy. Calibration is done by adjusting the controller probe calibration constants R_0 and ALPHA so that the process temperature as measured with a standard thermometer agrees more closely with the set-point. The thermometer used must be able to measure the temperature with higher accuracy than the desired accuracy of the system.

9.1 RTD Probe Calibration

9.1.1 Calibration Points

In calibrating the controller R_0 and ALPHA are adjusted to minimize the set-point error at each of two different temperatures. Any two reasonably separated temperatures may be used for the calibration however best results will be obtained when using temperatures which are just within the most useful operating range of the system. The further apart the calibration temperatures the larger will be the calibrated temperature range but the calibration error will also be greater over the range. For instance, if 50°C and 150°C are chosen as the calibration temperatures, the controller may achieve an accuracy of say $\pm 0.03^\circ\text{C}$ over the range 40 to 160°C . Choosing 80°C and 120°C may allow the controller to have a better accuracy of maybe $\pm 0.01^\circ\text{C}$ over the range 75 to 125°C but outside that range the accuracy may be only $\pm 0.05^\circ\text{C}$.

9.1.2 Measuring the Set-point Error

The first step in the calibration procedure is to measure the temperature errors (including sign) at the two calibration temperatures. First set the temperature to the lower set-point which we will call t_L . Wait for the system to reach the set-point and allow 15 minutes to stabilize at that temperature. Check the stability with the thermometer. When both the system and the thermometer have stabilized measure the system temperature with the thermometer and compute the temperature error err_L which is the actual temperature minus the set-point temperature. If for example the temperature is set for a lower set-point of $t_L = 50^\circ\text{C}$ and the controller reaches a measured temperature of 49.7°C then the error is -0.3°C .

Next, set the temperature for the upper set-point t_H and after stabilizing measure the temperature and compute the error err_H . For our example suppose the temperature was set for 150°C and the thermometer measured 150.1°C giving an error of $+0.1^\circ\text{C}$.

9.1.3 Computing R_0 and ALPHA

Before computing the new values for R_0 and ALPHA the current values must be known. The values may be found by either accessing the probe calibration menu from the controller panel or by inquiring through the digital interface.

The user should keep a record of these values in case they may need to be re-stored in the future. The new values R_0' and $ALPHA'$ are computed by entering the old values for R_0 and $ALPHA$, the calibration temperature set-points t_L and t_H , and the temperature errors err_L and err_H into the following equations,

$$R_0' = \left[\frac{err_H t_L - err_L t_H}{t_H - t_L} ALPHA + 1 \right] R_0$$

$$ALPHA' = \left[\frac{(1 + ALPHA t_H) err_L - (1 + ALPHA t_L) err_H}{t_H - t_L} + 1 \right] ALPHA$$

If for example R_0 and $ALPHA$ were previously set for 100.000 and 0.0038500 respectively and the data for t_L , t_H , err_L , and err_H were as given above then the new values R_0' and $ALPHA'$ would be computed as 100.193 and 0.0038272 respectively. Program the new values R_0 and $ALPHA$ into the controller. Check the calibration by setting the temperature to t_L and t_H and measuring the errors again. If desired the calibration procedure may be repeated again to further improve the accuracy.

9.1.4 Calibration Example

The controller is to be used between 75 and 125°C and it is desired to calibrate the system as accurately as possible for operation within this range. The current values for R_0 and $ALPHA$ are 100.000 and 0.0038500 respectively. The calibration points are chosen to be 80.00 and 120.00°C. The measured temperatures are 79.843 and 119.914°C respectively. Refer to Figure 9 for applying equations to the example data and computing the new probe constants.

$$R_0 = 100.000$$

$$\text{ALPHA} = 0.0038500$$

$$t_L = 80.00^\circ\text{C}$$

$$\text{measured } t = 79.843^\circ\text{C}$$

$$t_H = 120.00^\circ\text{C}$$

$$\text{measured } t = 119.914^\circ\text{C}$$

Compute errors,

$$\text{err}_L = 79.843 - 80.00^\circ\text{C} = -0.157^\circ\text{C}$$

$$\text{err}_H = 119.914 - 120.00^\circ\text{C} = -0.086^\circ\text{C}$$

Compute R_0' ,

$$R_0' = \left[\frac{(-0.086) \times 80.0 - (-0.157) \times 120.0}{120.0 - 80.0} \times 0.00385 + 1 \right] 100.000 = 100.115$$

Compute ALPHA,

$$\text{ALPHA}' = \left[\frac{(1 + 0.00385 \times 120.0)(-0.157) - (1 + 0.00385 \times 80.0)(-0.086)}{120.0 - 80.0} + 1 \right] 0.00385 = 0.0038387$$

Figure 9 Calibration Example — Platinum RTD Probe

10 Maintenance

The controller has been designed with the utmost care. Ease of operation and simplicity of maintenance have been a central theme in the product development. Therefore, with proper care the instrument should require very little maintenance. Avoid operating the instrument in dirty or dusty environments.

- A battery is used to maintain operating parameters in the unit. All operating parameters, including calibration parameters should be checked on a regular basis to insure accuracy and proper operation of the instrument. See the troubleshooting section for the procedure on checking the status of the battery.
- If the outside of the controller becomes soiled, it may be wiped clean with a damp cloth and mild detergent. Do not use harsh chemicals on the surface, which may damage the paint.
- If a hazardous material is spilt on or inside the equipment, the user is responsible for taking the appropriate decontamination steps as out-lined by the national safety council with respect to the material. MSDS sheets applicable to all fluids used in the baths should be kept in close proximity to the instrument.
- If the mains supply cord becomes damaged, replace it with a cord with the appropriate gauge wire for the current of the system. If there are any questions, call Hart Scientific Customer Service for more information.
- Before using any cleaning or decontamination method except those recommended by Hart, users should check with Hart Scientific Customer Service to be sure that the proposed method will not damage the equipment.
- If the instrument is used in a manner not in accordance with the equipment design, the operation of the controller may be impaired or safety hazards may arise.



WARNING: *When checking the over-temperature cutout, be sure that the temperature limits of the system fluid are not exceeded. Exceeding the temperature limits of the system fluid could cause harm to the operator, lab, and instrument.*

- The over-temperature cutout should be checked every 6 months to see that it is working properly. In order to check the user selected cutout, follow the controller directions (Section 7.10) for setting the cutout. Both the manual and the auto reset option of the cutout should be checked. Set the controller temperature higher than the cutout. Check to see if the display flashes cutout and the temperature is decreasing.

11 Troubleshooting

This section contains information on troubleshooting, and a wiring diagram. This information pertains to a number of bath models and certain specifics may not pertain to your model.

11.1 Troubleshooting

In the event that the user of the 7900 temperature controller encounters difficulty in operation, this section may help to find and solve the problem. Several possible problem conditions are described along with likely causes and solutions. If a problem arises, please read this section carefully and attempt to understand and solve the problem. Troubleshooting may require the assistance of a technician with at least a basic understanding of electronics. If the controller seems to be faulty or the problem cannot otherwise be solved then contact a Hart Scientific Authorized Service Center (see Section 1.3).



NOTE: *It is assumed that the controller is being used to control a calibration bath.*

Problem	Possible Causes and Solutions
The heater indicator LED stays red but the temperature does not increase	<p>The problem may be either insufficient heating or no heating at all. Insufficient heating may be caused by the amount of cooling to the system being greater than the amount of heat the heater is capable of supplying. Check that the heater is operational using a clamp-on ammeter to measure the current to the heater. If the heater is receiving current but not heating enough, either replace the heater with one of greater rating (but less than 20 A) or decrease the amount of cooling to the system.</p> <p>If the heater is not receiving power at all, use a voltmeter to verify that voltage is present at the heater connection on the internal terminal block. If voltage is present, check the heater for correct wiring. An ohm-meter may help to find a discontinuity in the wiring. Check for a shorted heater. The solid-state relay may not be operating and needs to be replaced. Contact an Authorized Service Center.</p> <p>If the heaters are not energized, check the heater fuses. Replace if the fuses are blown. If the fuses blow a second time, contact an Authorized Service Center.</p>

Problem	Possible Causes and Solutions
The controller display flashes "CUT-OUT" and the heater does not operate	<p>The display will flash "CUT-OUT" alternately with the process temperature. If the process temperature displayed seems to be grossly in error then also consult the problem "<i>The display flashes "CUT-OUT" and incorrect process temperature</i>" below. A problem with the thermocouple probe, the cutout operation, or the cutout circuitry may cause the cutout to remain in this condition.</p> <p>Check that the thermocouple probe is plugged into the controller and wired correctly. Check that the probe temperature is well below the programmed set-point. If not then reset the cutout temperature to a value well above the probe temperature or wait for the temperature to cool well below the cutout set-point. If the cutout is set for manual reset mode then after the temperature cools the user must also manually reset the cutout according to the directions in this manual under the section on the cut-out.</p> <p>If everything appears OK, the electronic hardware may have developed a failure. Contact an Authorized Service Center.</p>
The display flashes "CUT-OUT" and incorrect process temperature	<p>The problem may be that the controller's voltmeter circuit is not functioning properly. A problem could exist with the memory back-up battery. If the battery power is insufficient to maintain the memory, data may become scrambled causing all sorts of strange symptoms. A large static discharge may also affect data in memory. The memory may be reset by holding the "SET" and "EXIT" keys down while power to the controller is switched on. The display will show "—, n, t—" indicating the memory is being initialize. At this point each of the controller parameters and calibration constants must be reprogrammed into memory. If the problem is solved but reoccurs, the battery should be replaced. If the problem is not fixed, there may be a failed electronic component. In either case, contact an Authorized Service Center (see Section 1.3).</p>
The displayed process temperature is in error and the controller remains in the cooling or heating state at any set-point value	<p>A typical cause of this problem is the control probe. The probe may be disconnected, wired incorrectly, or incompatible with the controller. Check that the probe is connected and wired properly. Verify that the probe is of the correct type for which the controller was configured to use. If the probe is not correct, use the correct probe.</p>
The controller controls or attempts to control at an inaccurate temperature	<p>Check that the calibration parameters are all correct according to the certification sheet. If not, reprogram the constants. The memory backup battery may be weak causing errors in data as described in "<i>The display flashes "CUT-OUT" and incorrect process temperature</i>" above.</p> <p>If the users own probe is used, the calibration parameters, namely R_p and AL-PHA, may need to be adjusted to more closely match the characteristics of the probe. Calibration assistance may be obtained from an Authorized Hart Scientific Service Center. If the probe was purchased from Hart and the parameters all agree with the certification sheet but the controller does not meet the specification then the controller may need to recalibrated. If this is the case, rough handling in shipping may have caused shock to the probe or sensitive electronic components. Contact an Authorized Service Center (see Section 1.3).</p>
The controller shows that the output power is steady but the process temperature is unstable	<p>The gain may be increased to achieve better control stability. Normally the controller is used with systems that have fairly quick response times and require narrow proportional bands. In some systems with very slow response times, the proportional band may need to be set to a value larger than what is normally allowed with the controller. Internal jumpers on the lower PC board allow the gain to be increased. If this is necessary please contact an Authorized Service Center (see Section 1.3) for assistance.</p>

Problem	Possible Causes and Solutions
The controller alternately heats for a while then cools	The gain is probably too high causing the system to oscillate. Lower the gain until the oscillation stops. In some systems with large mass and slow response, the gain must be lowered significantly to achieve steady control without oscillation. If the gain is set as low as 1 and the system still oscillates, the gain range may need to be changed. Contact an Authorized Service Center (see Section 1.3).
The controller erratically heats then cools, control is unstable	If both the process temperature and output power do not vary periodically but in a very erratic manner, the problem may not be oscillation due to instability but excess noise in the system. Noise due to the control sensor should be less than 0.001°C. However, if the probe has been damaged, an intermittent short may have developed causing erratic behavior. Intermittent shorts in the heater or electronic circuitry in the controller may also be a possible cause. If feasible, try replacing the probe or heater. In fluid baths, improper stirring and/or uneven heating or cooling can also cause instability. In solid systems stability is typically much poorer than in fluid systems because of the much slower system response time. The response time can be optimized by placing the control probe as close as possible to the heater.
The heater heats continuously and the stirrer motor stirs sporadically or not at all	Check to see that the heater and stirrer motor are connected into the correct sockets on the back of the unit. If not, plug them in correctly. If they are plugged in correctly, contact an Authorized Service Center.
Power up	The controller is equipped with internal operator accessible fuses. If a fuse blows, it may be due to a power surge or failure of a component. Replace the fuse once. DO NOT replace the fuse with one of a higher current rating. Always replace the fuse with one of the same rating, voltage, and type. If the fuse blows a second time, it is likely caused by failure of a component part. Disconnect the heaters, stirrer motor, and/or LN ₂ Cooling. Check to see if the fuse(s) blow. Connect the heater, stirrer motor, and LN ₂ cooling one at a time. Check each time to see if the fuse(s) blow. If the fuse(s) blow only when the heater, stirrer motor, and/or LN ₂ cooling are connected, the fault may be in the system. If not, contact an Authorized Service Center (see Section 1.3).
The controller does not maintain controller parameters or parameters are reset each time the power to the unit is removed	<p>Note: Before performing the memory check, you need to record the controller calibration parameters (found in the CAL menu of the instrument) and any user-adjusted parameters that you have changed (such as the programmable set points and proportional band).</p> <p>Memory Check</p> <p>Doing a memory check is the easiest way to verify the ability of the battery to maintain controller parameters.</p> <ol style="list-style-type: none"> 1. Power off the instrument. 2. Disconnect the instrument from AC power for 10 seconds. 3. Reconnect the AC power and power on the instrument. 4. If the display shows <i>INIT</i> and/or the cycle count shows a low number such as 0002, the battery is spent and should be replaced. Contact an Authorized Service Center for assistance. 5. After replacing the battery, you must reprogram the calibration and user-adjustable parameters into the controller.

12 Appendix - 910 Bath Probe Adapter Instructions

Your new 7900 Controller for your Rosemount designed bath has a different size control PRT and an additional thermocouple (TC) cutout.

12.1 TC Cut-Out

Your Rosemount bath was not originally provided with a TC cutout. Therefore, provisions will have to be made to add this to the bath. May we suggest the following:

1. There is adequate space on the cover plate of the bath exactly across from the control probe to add the TC.
2. Remove the plate and flow chute from the bath (to keep metal shavings out of the bath).
3. Drill a hole in the plate using at least a #265 drill bit (17/64).
4. Attach the probe adapter to the plate.

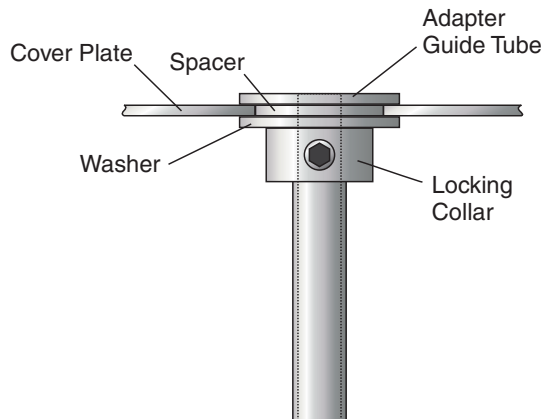

Figure 10 Probe Adapter

12.2 Control Probe

1. Remove your Rosemount control probe.
2. Remove the Swadgelok fitting from the cover plate.

12.3 Attaching the Probe Adapter

1. Remove the locking collar from the adapter.
2. Place the guide tube through the flow chute cover plate. If you are placing the adapter in the control probe hole, the small washer acts as a spacer to center the adapter. If you drilled the hole for the TC as outlined above, discard the small spacer washer for the TC adapter.
3. Slide the large washer and locking collar over the guide tube. Hold all pieces tightly as the locking set screw is tightened. The collar should be snugly compressed so that the adapter does not move in the hole.

12.4 Inserting the Probes

1. Replace the cover plate and flow chute on the bath.
2. Insert the probes in the adapters.