

8808A

Digital Multimeter

Calibration Manual

Table of Contents

Chapter	Title	Page
1	Introduction and Specifications.....	1-1
	Introduction.....	1-3
	Safety Information	1-3
	Symbols	1-4
	General Safety Summary.....	1-4
	Description of IEC 61010 Measurement Categories	1-6
	Manual Set	1-7
	About This Manual	1-7
	Operating Instructions.....	1-8
	Accessories	1-8
	General Specifications	1-9
	Voltage	1-9
	Dimensions	1-9
	Display.....	1-9
	Environment	1-9
	Safety.....	1-9
	EMC	1-9
	Triggering.....	1-9
	Math Functions.....	1-9
	Electrical.....	1-9
	Remote Interfaces.....	1-10
	Warranty	1-10
	Electrical Specifications	1-10
	DC Voltage Specifications	1-10
	AC Voltage Specifications	1-10
	Resistance.....	1-12
	DC Current	1-12
	AC Current	1-13
	Frequency	1-14
	Continuity.....	1-14
	Diode Test	1-14
2	General Maintenance	2-1
	Introduction.....	2-3

General Maintenance Information	2-3
Required Equipment	2-3
Static Safe Handling	2-3
Cleaning	2-4
Storing and Shipping the Meter	2-4
Power Considerations	2-4
Selecting the Line Voltage	2-4
Replacing the Fuses	2-5
Line-Power Fuse	2-5
Current-Input Fuses	2-6
If the Meter Does Not Turn On	2-7
Display Tests	2-7
3 Performance Verification and Calibration	3-1
Introduction	3-3
Required Equipment	3-3
Direct Voltage Verification	3-4
Alternating Voltage Verification	3-5
4-Wire Ohms Verification	3-6
2-Wire Ohms Verification	3-7
Direct Current Verification	3-8
Alternate Current Verification	3-10
Frequency Verification	3-11
Adjustment (Calibration)	3-11
Equipment for Calibration	3-11
Adjustment Process	3-11
Front Panel Adjustments	3-11
RS-232 Calibration (Manual)	3-16
RS-232 Calibration (Automatic)	3-17
Calibration Points	3-17
4 List of Replaceable Parts	4-1
Introduction	4-3
How to Obtain Parts	4-3
How to Contact Fluke	4-3
Parts Lists	4-4

List of Tables

Table	Title	Page
1-1.	Safety and Electrical Symbols.....	1-4
1-2.	Accessories.....	1-8
2-1.	Line Voltage to Fuse Rating.....	2-5
3-1.	Required Test Equipment.....	3-3
3-2.	Direct Voltage Verification Steps.....	3-4
3-3.	Alternating Voltage Verification Steps.....	3-5
3-4.	4-Wire Ohms Verification Steps.....	3-6
3-5.	2-Wire Ohms Verification Steps.....	3-7
3-6.	Direct Current Verification Steps.....	3-9
3-7.	Alternating Current Verification Steps.....	3-10
3-8.	Frequency Verification Steps.....	3-11
3-9.	Adjustment Steps.....	3-12
4-1.	Front-Panel Assembly.....	4-4
4-2.	Chassis Assembly.....	4-6

List of Figures

Figure	Title	Page
1-1.	IEC 61010 Measurement Category (CAT) Levels.....	1-6
2-1.	Replacing the Line Power Fuse.....	2-5
2-2.	Replacing the Current-Input Fuses.....	2-7
2-3.	Display Elements	2-8
3-1.	Direct and Alternating Voltage Verification Test Setup	3-4
3-2.	4-Wire Ohms Test Setup	3-6
3-3.	2-Wire Ohms Test Setup	3-7
3-4.	Less than 2 Amps Direct and Alternating Current Test Setup	3-8
3-5.	2 Amps and Greater Direct and Alternating Current Test Setup.....	3-9
4-1.	Front-Panel Assembly	4-5
4-2.	Chassis Assembly.....	4-7

Chapter 1

Introduction and Specifications

Title	Page
Introduction.....	1-3
Safety Information	1-3
Symbols	1-4
General Safety Summary.....	1-4
Description of IEC 61010 Measurement Categories	1-6
Manual Set	1-7
About This Manual	1-7
Operating Instructions.....	1-8
Accessories	1-8
General Specifications	1-9
Voltage	1-9
Dimensions.....	1-9
Display.....	1-9
Environment	1-9
Safety	1-9
EMC	1-9
Triggering.....	1-9
Math Functions.....	1-9
Electrical.....	1-9
Remote Interfaces.....	1-9
Warranty	1-10
Electrical Specifications	1-10
DC Voltage Specifications	1-10
AC Voltage Specifications	1-10
Resistance.....	1-12
DC Current	1-12
AC Current	1-13
Frequency	1-14
Continuity.....	1-14
Diode Test	1-14

Introduction

The Fluke 8808A Digital Multimeter (hereafter referred to as the Meter) is a 5-1/2 digit dual-display multimeter designed for bench-top, field service, and system applications. The multiple measurement functions, plus the RS-232 remote interface, make the Meter an ideal candidate for precision manual measurements and use in automated systems. For portability, the Meter includes a carrying handle that also serves as a bail for bench-top operation.

Some features provided by the Meter are:

- A dual vacuum fluorescent display that allows two properties of an input signal to be displayed at the same time (e.g., ac voltage in one display and frequency in the other)
- 5-1/2 digit resolution
- True-rms ac
- 2, 4 wire resistance or patented 2x4 wire resistance measurement technique
- 200 mV to 1000 Vdc range with 1 μ V sensitivity
- 200 mV to 750 Vac rms with 1 μ V sensitivity
- 200 Ω to 100 M Ω with 1 m Ω sensitivity
- 200 μ A to 10 Adc with 1 nA sensitivity
- 20 mA to 10 Aac with 100 nA sensitivity
- Frequency measurements from 20 Hz to 1 MHz
- Continuity and diode test
- Measurement rates of 2.5, 20 and 100 samples/second (slow, medium and fast, respectively)
- Front-panel setup key for single key access to saved setups
- A compare mode to determine if a measurement is within defined limits
- Remote operation via the RS-232 interface
- Closed-case calibration (no internal calibration adjustments)

Safety Information

This section addresses safety considerations and describes symbols that may appear on the Meter or in the manual.

A **Warning** statement identifies conditions or practices that could result in injury or death.

A **Caution** statement identifies conditions or practices that could result in damage to the Meter or equipment to which it is connected.

















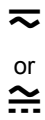

Warning

To avoid electric shock, personal injury, or death, carefully read the information in the “Safety Information” section, before attempting to install, use or service the Meter.

Symbols

Table 1-1 lists safety and electrical symbols that appear on the Meter or in this manual.

Table 1-1. Safety and Electrical Symbols

Symbol	Description	Symbol	Description
	Risk of danger. Important information. See manual.		Standby power ON / OFF
	Hazardous voltage. Voltage > 30 V dc or ac peak might be present.		Earth ground
	AC (Alternating Current)		Capacitance
	DC (Direct Current)		Diode
 or 	AC or DC (Alternating or Direct Current)		Fuse
	Continuity test or continuity beeper tone		Digital signal
	Potentially hazardous voltage		Maintenance or Service
	Double insulated		Recycle
	Static awareness. Static discharge can damage parts.		Do not dispose of this product as unsorted municipal waste. Go to Fluke's website for recycling information.
CAT II	Measurement Category II is for measurements performed on circuits directly connected to the low voltage installation.	CAT I	Measurement Category I is for measurements not directly connected to mains.

General Safety Summary

This instrument has been designed and tested in accordance with the European standard publication EN61010-1: 2001 and U.S. / Canadian standard publications UL 61010-1:2004 and CAN/CSA-C22.2 No.61010.1:2004. The Meter has been supplied in a safe condition.

This manual contains information and warnings that must be observed to keep the instrument in a safe condition and ensure safe operation.

To use the Meter correctly and safely, read and follow the precautions below and follow all the safety instructions or warnings given throughout this manual that relate to specific measurement functions. In addition, follow all generally accepted safety practices and procedures required when working with and around electricity.

Warning

To avoid possible electric shock, personal injury, or death, read the following before using the Meter:

- **Use the Meter only as specified in this manual, or the protection provided by the Meter might be impaired.**
- **Do not use the Meter in damp or wet environments.**

- **Inspect the Meter before using it. Do not use the Meter if it appears damaged.**
- **Inspect the test leads before use. Do not use them if insulation is damaged or metal is exposed. Check the test leads for continuity. Replace damaged test leads before using the Meter.**
- **Verify the Meter's operation by measuring a known voltage before and after using it. Do not use the Meter if it operates abnormally. Protection may be impaired. If in doubt, have the Meter serviced.**
- **Whenever it is likely that safety protection has been impaired, make the Meter inoperative and secure it against any unintended operation.**
- **Have the Meter serviced only by qualified service personnel.**
- **Do not apply more than the rated voltage, as marked on the Meter, between the terminals or between any terminal and earth ground.**
- **Always use the power cord and connector appropriate for the voltage and outlet of the country or location in which you are working.**
- **Remove test leads from the Meter before opening the case.**
- **Never remove the cover or open the case of the Meter without first removing it from the main power source.**
- **Never operate the Meter with the cover removed or the case open.**
- **Use caution when working with voltages above 30 V ac rms, 42V ac peak, or 42 V dc. These voltages pose a shock hazard.**
- **Use only the replacement fuses specified by the manual.**
- **Use the proper terminals, function and range for your measurements.**
- **Do not operate the Meter around explosive gas, vapor or dust.**
- **When using probes, keep your fingers behind the finger guards.**
- **When making electrical connections, connect the common test lead before connecting the live test lead. When disconnecting, disconnect the live test lead before disconnecting the common test lead.**
- **Disconnect circuit power and discharge all high voltage capacitors before testing resistance, continuity, diodes, or capacitance.**

- Before measuring current, check the Meter's fuses and turn OFF power to the circuit before connecting the Meter to the circuit.
- When servicing the Meter, use only specified replacement parts.

Description of IEC 61010 Measurement Categories

The IEC 61010 safety standard defines four Overvoltage (Installation) Categories (CAT I to CAT IV) based on the magnitude of danger from transient impulses as shown in Figure 1-1.

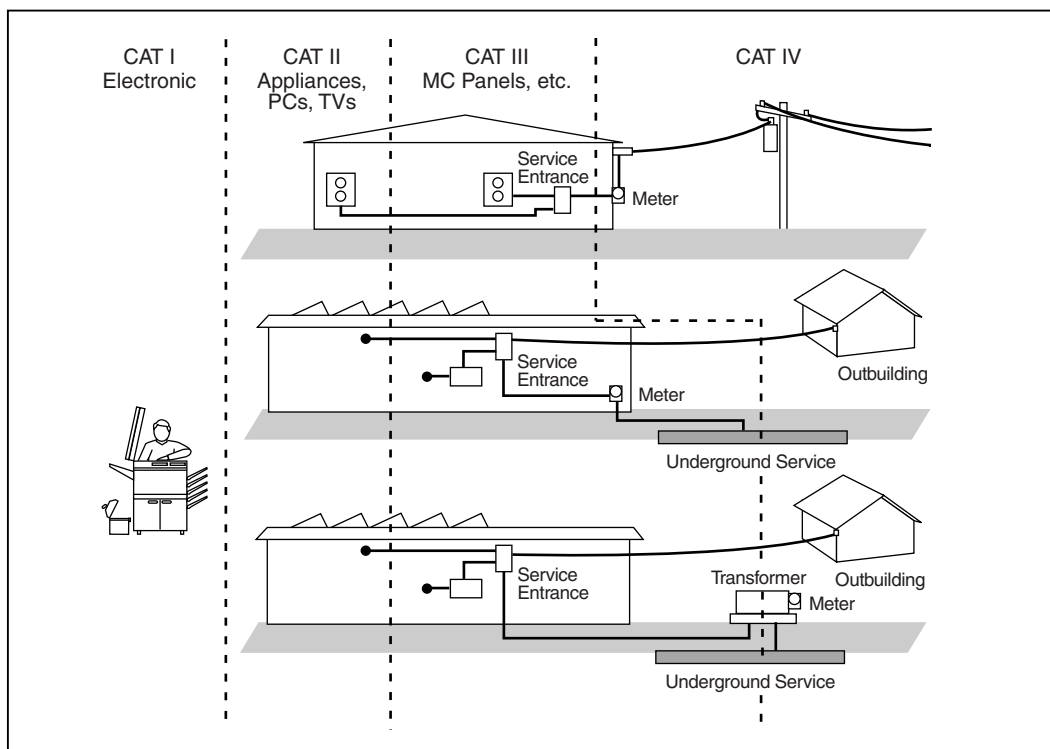

Figure 1-1. IEC 61010 Measurement Category (CAT) Levels

cat_levels.eps

The IEC 61010 Measurement CAT level indicates the level of protection the instrument provides against impulse withstand voltage.

CAT I equipment is designed to protect against transients from high-voltage, low-energy sources, such as electronic circuits or a copy machine.

CAT II equipment is designed to protect against transients from energy-consuming equipment supplied from the fixed installation, such as TVs, PCs, portable tools, and other household appliances.

CAT III equipment is designed to protect against transients in equipment in fixed equipment installations, such as distribution panels, feeders and short branch circuits, and lighting systems in large buildings.

CAT IV equipment is designed to protect against transients from the primary supply level, such as an electricity meter or an overhead or underground utility service.

Manual Set

The manual set for this Meter consists of a printed *Getting Started Manual*, and a *Users and Calibration Manual* on a CD-ROM. The *Getting Started Manual* contains basic getting started information, contacting Fluke, unpacking, and general specifications.

About This Manual

This calibration manual contains information for a technician to maintain the Meter, verify its performance, and if necessary, calibrate the Meter to specifications. The manual is divided into the following chapters:

Chapter 1 – Introduction and Specifications

This chapter introduces the Fluke 8808A Digital Multimeter, describing its features, and accessories. This chapter also discusses use of the Calibration Manual and the various conventions used in describing the meter's circuitry and presents a complete set of specifications.

Chapter 2 – General Maintenance

Chapter 2 provides maintenance information covering handling, cleaning, and fuse replacement.

Chapter 3 – Performance Verification and Calibration

This chapter provides performance verification procedures related to the specifications presented in Chapter 1. To maintain these specifications, a full adjustment/calibration procedure is also presented.

Chapter 4 – Parts

Chapter 4 includes a list user replaceable parts and information on how and where to order parts.

Operating Instructions

Full operating instructions are provided in the *Fluke 8808A Users Manual*. Reference to these instructions may be necessary during some of the procedures presented in this Calibration Manual.

Accessories

Table 1-2 lists the available accessories for the 8808A.

Table 1-2. Accessories

Item	Model / Part Number
Premium Test Lead Set	TL71
Fuse, .25*1.25, 0.063 A, 250 V, Slow	163030
Fuse, .25*1.25, 0.125 A, 250 V, Slow	166488
F1 - Fuse, 11 A, 1000 V, Fast, 406INX1.5IN, BULK	803293
F2 - Fuse, 440 mA, 1000 V, Fast, 406INX1.375IN, BULK	943121
Rack Mount Kit 8845A & 8846A Single	Y8846S
Rack Mount Kit 8845A & 8846A Dual	Y8846D
RS-232 Cable (2 m)	RS43
Precision Electronic Prob Set	TL910
2X4 Wire Ohms 1000 V Test Lead	TL2X4W-PTII
FlukeView Forms Basic Software	FVF-SC5
FlukeView Forms Software Upgrade to enhanced version	FVF-UG

General Specifications

Voltage

100V Setting	90 V to 110 V
120V Setting	108 V to 132 V
220V Setting	198 V to 242 V
240V Setting	216 V to 264 V
Frequency	47 Hz to 440 Hz
Power Consumption	15 VA peak (10 W average)

Dimensions

Height	88 mm (3.46 in)
Width	217 mm (8.56 in)
Depth	297 mm (11.7 in)
Weight	2.1 kg (4.6 lb)

Display

Vacuum Fluorescent Display, segment

Environment

Temperature

Operating	0 °C to 50 °C
Storage	-40 °C to 70 °C
Warm Up	½ hour to full uncertainty specifications

Relative Humidity (non-condensing)

Operating	<90 % (0 °C to 28 °C)
	<75 % (28 °C to 40 °C)
	<45 % (40 °C to 50 °C)
Storage	-40 °C to 70 °C <95 %

Altitude

Operating	2,000 Meters
Storage	12,000 Meters
Vibration	Complies with MIL-PRF-28800F Class 3

Safety

Complies with IEC 61010-1:2001, ANSI/ISA 61010-1 (S82.02.01):2004, UL 61010-1:2004, CAN/CSA C22.2 No. 61010.1:2004, CAT I 1000V/CAT II 600 V

EMC

Designed to comply with IEC 61326-1:1997+A1:1998+A2:2000

Triggering

Trigger Delay	400 ms
External Trigger Delay	<2 ms
External Trigger Jitter	<1 ms
Trigger Input	TTL Levels
Trigger Output	5 V max

Math Functions

Min/max, relative, hold, compare and dB functions

Electrical

Input Protection	1000 V all ranges
Overrange	10 % on the largest ranges of all functions except continuity and diode test

Remote Interfaces

RS-232C

Warranty

One year

Electrical Specifications

Specifications are valid for 5-½ digit mode and after at least a half-hour warm-up.

DC Voltage Specifications

Maximum Input	1000 V on any range
Common Mode Rejection	120 dB at 50 or 60 Hz ±0.1% (1 kΩ unbalance)
Normal Mode Rejection	80 dB at Slow Rate
A/D Nonlinearity	15 ppm of range
Input Bias Current	<30 pA at 25 °C
Settling Considerations	Measurement settling times are affected by source impedance, cable dielectric characteristics, and input signal changes

Input Characteristics

Range	Full-Scale (5-1/2 Digits)	Resolution			Input Impedance
		Slow	Medium	Fast	
200 mV	199.999 mV	1 μV	10 μV	10 μV	>10 GΩ ^[1]
2 V	1.99999 V	10 μV	100 μV	100 μV	>10 GΩ ^[1]
20 V	19.9999 V	100 μV	1000 μV	1000 μV	10 MΩ±1 %
200 V	199.999 V	1 mV	10 mV	10 mV	10 MΩ±1 %
1000 V	1000.00 V	10 mV	100 mV	100 mV	10 MΩ±1 %

Notes:
[1] At some dual display measurements, the input impedance of 200 mV and 2 V ranges may be changed to 10 MΩ.

Range	Uncertainty ^[1]		Temperature Coefficient/°C Outside 18 – 28 °C
	90 days	1 year	
	23 °C ± 5 °C	23 °C ± 5 °C	
200 mV	0.01 + 0.003	0.015 + 0.004	0.0015 + 0.0005
2 V	0.01 + 0.002	0.015 + 0.003	0.001 + 0.0005
20 V	0.01 + 0.003	0.015 + 0.004	0.0020 + 0.0005
200 V	0.01 + 0.002	0.015 + 0.003	0.0015 + 0.0005
1000 V	0.01 + 0.002	0.015 + 0.003	0.0015 + 0.0005

Notes:
[1] Uncertainty given as ± (% of reading + % of range)

AC Voltage Specifications

AC Voltage specifications are for ac sinewave signals >5 % of range. For inputs from 1 % to 5 % of range and <50 kHz, add an additional error of 0.1 % of range, and for 50 kHz to 100 kHz, add 0.13 % of range.

Maximum Input	750 V rms or 1000 V peak or 8 x 10 ⁷ Volts-Hertz product
Measurement Method	AC-coupled true-rms. Measures the ac component of input with up to 1000 V dc bias on any range.
AC Filter Bandwidth	20 Hz – 100 kHz
Common Mode Rejection	60 dB at 50 Hz or 60 Hz (1 kΩ unbalance)
Maximum Crest Factor	3:1 at Full Scale
Additional Crest Factor Errors (<100 Hz)	Crest Factor 1-2, 0.05 % of full scale Crest Factor 2-3, 0.2 % of full scale Only applies for non-sinusoid signals

Input Characteristics

Range	Full-Scale (5-1/2 Digits)	Resolution			Input Impedance
		Slow	Medium	Fast	
200 mV	199.999 mV	1 μ V	10 μ V	10 μ V	1 M Ω \pm 2 % shunted by <100 pf
2 V	1.99999 V	10 μ V	100 μ V	100 μ V	
20 V	19.9999 V	100 μ V	1000 μ V	1000 μ V	
200 V	199.999 V	1 mV	10 mV	10 mV	
750 V	750.00 V	10 mV	100 mV	100 mV	

Range	Frequency	Uncertainty ^[1]		Temperature Coefficient/ $^{\circ}$ C Outside 18 – 28 $^{\circ}$ C
		90 days	1 year	
		23 $^{\circ}$ C \pm 5 $^{\circ}$ C	23 $^{\circ}$ C \pm 5 $^{\circ}$ C	
200 mV	20 Hz – 45Hz	0.8 + 0.05	0.9 + 0.05	0.01 + 0.005
	45 Hz – 20 kHz	0.15 + 0.05	0.2 + 0.05	0.01 + 0.005
	20 kHz – 50 kHz	0.3 + 0.05	0.35 + 0.05	0.01 + 0.005
	50 kHz – 100 kHz	0.8 + 0.05	0.9 + 0.05	0.05 + 0.01
2 V	20 Hz – 45Hz	0.8 + 0.05	0.9 + 0.05	0.01 + 0.005
	45 Hz – 20 kHz	0.15 + 0.05	0.2 + 0.05	0.01 + 0.005
	20 kHz – 50 kHz	0.3 + 0.05	0.35 + 0.05	0.01 + 0.005
	50 kHz – 100 kHz	0.8 + 0.05	0.9 + 0.05	0.05 + 0.01
20 V	20 Hz – 45 Hz	0.8 + 0.05	0.9 + 0.05	0.01 + 0.005
	45 Hz – 20 kHz	0.15 + 0.05	0.2 + 0.05	0.01 + 0.005
	20 kHz – 50 kHz	0.3 + 0.05	0.35 + 0.05	0.01 + 0.005
	50 kHz – 100 kHz	0.8 + 0.05	0.9 + 0.05	0.05 + 0.01
200 V	20 Hz – 45Hz	0.8 + 0.05	0.9 + 0.05	0.01 + 0.005
	45 Hz – 20 kHz	0.15 + 0.05	0.2 + 0.05	0.01 + 0.005
	20 kHz – 50 kHz	0.3 + 0.05	0.35 + 0.05	0.01 + 0.005
	50 kHz – 100 kHz	0.8 + 0.05	0.9 + 0.05	0.05 + 0.01
750 V	20 Hz – 45Hz	0.8 + 0.05	0.9 + 0.05	0.01 + 0.005
	45 Hz – 20 kHz	0.15 + 0.05	0.2 + 0.05	0.01 + 0.005
	20 kHz – 50 kHz	0.3 + 0.05	0.35 + 0.05	0.01 + 0.005
	50 kHz – 100 kHz	0.8 + 0.05	0.9 + 0.05	0.05 + 0.01

Notes:
[1] Uncertainty given as \pm (% of reading + % of range)

Resistance

Specifications are for 4-wire resistance function, or 2-wire resistance with REL. If REL is not used, add 0.2 Ω for 2-wire resistance plus lead resistance.

Measurement Method Current source referenced to LO input

Max Lead Resistance (4-wire ohms) 10 % of range per lead for 200 Ω, 2 kΩ ranges. 1 kΩ per lead on all other ranges.

Input Protection 1000 V on all ranges

Input Characteristics

Range	Full-Scale (5-1/2 Digits)	Resolution			Current Source
		Slow	Medium	Fast	
200 Ω	199.999 Ω	0.001 Ω	0.01 Ω	0.01 Ω	0.8 mA
2 kΩ	1.99999 kΩ	0.01 Ω	0.1 Ω	0.1 Ω	0.8 mA
20 kΩ	19.9999 kΩ	0.1 Ω	1 Ω	1 Ω	0.08 mA
200 kΩ	199.999 kΩ	1 Ω	10 Ω	10 Ω	0.008 mA
2 MΩ	1.99999 MΩ	10 Ω	100 Ω	100 Ω	0.9 μA
20 MΩ	19.9999 MΩ	100 Ω	1 kΩ	1 kΩ	0.16 μA
100 MΩ	100.000 MΩ	1 kΩ	10 kΩ	10 kΩ	0.16 μA 10 MΩ

Range	Uncertainty ^[1]		Temperature Coefficient/°C Outside 18 – 28 °C
	90 days	1 year	
	23 °C ± 5 °C	23 °C ± 5 °C	
200 Ω	0.02 + 0.004	0.03 + 0.004	0.003 + 0.0006
2 kΩ	0.015 + 0.002	0.02 + 0.003	0.003 + 0.0005
20 kΩ	0.015 + 0.002	0.02 + 0.003	0.003 + 0.0005
200 kΩ	0.015 + 0.002	0.02 + 0.003	0.003 + 0.0005
2 MΩ	0.03 + 0.003	0.04 + 0.004	0.004 + 0.0005
20 MΩ	0.2 + 0.003	0.25 + 0.003	0.01 + 0.0005
100 MΩ	1.5 + 0.004	1.75 + 0.004	0.2 + 0.0005

Notes:
[1] Uncertainty given as ± (% of reading + % of range)

DC Current

Input Protection Tool accessible 11 A / 1000 V and 440 mA / 1000 V fuses.

Shunt Resistance 0.01 Ω for 2 A and 10 A ranges

1 Ω for 20 mA and 200 mA

Burden voltage < 5 mV for 200 μA and 2 mA range.

Input Characteristics

Range	Full-Scale (5-1/2 Digits)	Resolution			Burden Voltage
		Slow	Medium	Fast	
200 μA	199.999 μA	0.001 μA	0.01 μA	0.01 μA	<5 mV
2 mA	1999.99 μA	0.01 μA	0.1 μA	0.1 μA	<5 mV
20 mA	19.9999 mA	0.1 μA	1 μA	1 μA	<0.05 V
200 mA	199.999 mA	1 μA	10 μA	10 μA	<0.5 V
2 A	1.99999 A	10 μA	100 μA	100 μA	<0.1 V
10 A	10.0000 A	100 μA	1 mA	1 mA	<0.5 V

Range	Uncertainty ^[1]		Temperature Coefficient/°C Outside 18 – 28 °C
	90 days	1 year	
	23 °C ± 5 °C	23 °C ± 5 °C	
200 µA	0.02 + 0.005	0.03 + 0.005	0.003 + 0.001
2 mA	0.015 + 0.005	0.02 + 0.005	0.002 + 0.001
20 mA	0.03 + 0.02	0.04 + 0.02	0.005 + 0.001
200 mA	0.02 + 0.005	0.03 + 0.008	0.005 + 0.001
2 A	0.05 + 0.02	0.08 + 0.02	0.008 + 0.001
10 A	0.18 + 0.01	0.2 + 0.01	0.008 + 0.001

Notes:
[1] Uncertainty given as ± (% of reading + % of range)

AC Current

The following ac current specifications are for sinusoidal signals with amplitudes greater than 5 % of range. For inputs from 1 % to 5 % of range, add an additional error of 0.1 % of range.

- Input Protection** Tool accessible 11 A / 1000 V and 440 mA / 1000 V fuses
- Measurement Method** AC-coupled True RMS
- Shunt Resistance** 0.01 Ω for 2 A and 10 A ranges
1 Ω for 20 mA and 200 mA
- AC Filter Bandwidth** 20 Hz – 100 kHz
- Maximum Crest Factor** 3:1 at Full Scale
- Additional Crest Factor Errors (<100 Hz)** Crest Factor 1-2, 0.05 % of full scale
Crest Factor 2-3, 0.2 % of full scale
Only applies to non-sinusoid signals

Input Characteristics

Range	Full-Scale (5-1/2 Digits)	Resolution			Burden Voltage
		Slow	Medium	Fast	
20 mA	19.9999 mA	0.1 µA	1 µA	1 µA	<0.05 V
200 mA	199.999 mA	1 µA	10 µA	10 µA	<0.5 V
2 A	1.99999 A	10 µA	100 µA	100 µA	<0.1 V
10 A	10.0000 A	100 µA	1 mA	1 mA	<0.5 V

Range	Frequency	Uncertainty ^[1]		Temperature Coefficient/°C Outside 18 – 28 °C
		90 days	1 year	
		23 °C ± 5 °C	23 °C ± 5 °C	
20 mA	20 Hz - 45Hz	1 + 0.05	1.25 + 0.06	0.015 + 0.005
	45 Hz - 2 kHz	0.25 + 0.05	0.3 + 0.06	0.015 + 0.005
200 mA	20 Hz - 45Hz	0.8 + 0.05	1 + 0.06	0.015 + 0.005
	45 Hz - 2 kHz	0.25 + 0.05	0.3 + 0.06	0.015 + 0.005
2 A	20 Hz - 45Hz	1 + 0.05	1.25 + 0.06	0.015 + 0.005
	45 Hz - 2 kHz	0.25 + 0.05	0.3 + 0.06	0.015 + 0.005
10 A	20 Hz - 45Hz	1 + 0.1	1.25 + 0.12	0.015 + 0.005
	45 Hz - 2 kHz	0.35 + 0.1	0.5 + 0.12	0.015 + 0.005

Notes:
[1] Uncertainty given as ± (% of reading + % of range)

Frequency

- Gate Time** 131 ms
- Measurement Method** AC-coupled input using the ac voltage measurement function.
- Settling Considerations** When measuring frequency after a dc offset voltage change, errors may occur. For the most accurate measurement, wait up to 1 second to allow input blocking RC time constant to settle.
- Measurement Considerations** To minimize measurement errors, shield inputs from external noise when measuring low voltage, low frequency signals.

Range	Frequency	Uncertainty		Temperature Coefficient/°C Outside 18 – 28 °C
		90 days	1 year	
		23 °C ± 5 °C	23 °C ± 5 °C	
100 mV to 750 V ^[1,2]	20 Hz – 2 kHz	0.01 + 0.002	0.01 + 0.003	0.002 + 0.001
	2 kHz – 20 kHz	0.01 + 0.002	0.01 + 0.003	0.002 + 0.001
	20 kHz – 200 kHz	0.01 + 0.002	0.01 + 0.003	0.002 + 0.001
	200 kHz – 1 MHz	0.01 + 0.004	0.01 + 0.006	0.002 + 0.002
Notes: [1] Input > 100 mV [2] Limited to 8* 10 ⁷ V Hz				

Continuity

- Continuity Threshold** 20 Ω
- Test Currents** 1 mA
- Response Time** 100 samples/sec with audible tone
- Rate** Fast
- Maximum Reading** 199.99 Ω
- Resolution** 0.01 Ω

Diode Test

- Response Time** 100 samples/sec with audible tone
- Rate** Fast
- Maximum Reading** 1.9999 V
- Resolution** 0.1 mV

Chapter 2

General Maintenance

Title	Page
Introduction.....	2-3
General Maintenance Information	2-3
Required Equipment.....	2-3
Static Safe Handling.....	2-3
Cleaning.....	2-4
Storing and Shipping the Meter	2-4
Power Considerations	2-4
Selecting the Line Voltage	2-4
Replacing the Fuses.....	2-5
Line-Power Fuse	2-5
Current-Input Fuses.....	2-6
If the Meter Does Not Turn On.....	2-7
Display Tests.....	2-7

Introduction

This chapter provides handling, cleaning, fuse replacement, and display test instructions for the Meter.

General Maintenance Information

The following sections describe how to maintain the Meter.

Required Equipment

Equipment required for calibration, troubleshooting, and repair of the Meter is listed in Table 3-1.

Static Safe Handling

All integrated circuits, including surface mounted ICs, are susceptible to damage from electrostatic discharge (ESD). Modern integrated circuit assemblies are more susceptible to damage from ESD than ever before.

Integrated circuits today can be built with circuit lines less than one micron thick, allowing more than a million transistors on a 1/4-inch square chip. These submicron structures are sensitive to static voltages under 100 volts. This much voltage can be generated on a dry day by simply moving your arm. A person can develop a charge of 2,000 volts by walking across a vinyl tile floor, and polyester clothing can easily generate 5,000 to 15,000 volts during movement against the wearer. These low voltage static problems are often undetected, because a static charge must be in the 30,000 to 40,000 volt range before a person will feel a shock.

Most electronic components manufactured today can be degraded or destroyed by ESD. While protection networks are used in CMOS devices, they can only reduce, not eliminate, component susceptibility to ESD.

ESD may not cause an immediate failure in a component; a delayed failure or "wounding" effect is caused when the semiconductor's insulation layers or junctions are punctured. The static problem is thus complicated in that failure may occur anywhere from two hours to six months after the initial damage.

Two failure modes are associated with ESD. First, a person who has acquired a static charge can touch a component or assembly and cause a transient discharge to pass through the device. The resulting current ruptures the junctions of a semiconductor. The second failure mode does not require contact with another object. Simply exposing a device to the electric field surrounding a charged object can destroy or degrade a component. MOS devices can fail when exposed to static fields as low as 30 volts.

Observe the following rules for handling static-sensitive devices:

1. Handle all static-sensitive components in a static-safe work area.

Use grounded static-control table mats on all repair benches, and always wear a grounded wrist strap. Handle boards by their nonconductive edges only. Store plastic, vinyl, and Styrofoam objects outside the work area.

2. Store and transport all static-sensitive components and assemblies in static shielding bags or containers.

Static-shielding bags and containers protect components and assemblies from direct static discharge and external static fields. Store components in their original packages until they are ready for use.

Cleaning

⚠ ⚠ Warning

To avoid electric shock or damage to the Meter, never get water inside the Meter.

⚠ Caution

To avoid damaging the Meter's housing, do not apply solvents to the Meter.

If the Meter requires cleaning, wipe it down with a cloth lightly dampened with water or a mild detergent. Do not use aromatic hydrocarbons, chlorinated solvents, or methanol-based fluids to wipe down the Meter.

Storing and Shipping the Meter

To prepare the Meter for storage or shipping, place it inside a sealed bag, fit the bag into the packing material inside the original shipping container, and then secure the package. Use the original shipping container if possible, as it provides shock isolation for normal handling operations. If the original shipping container is not available, use a box that is 17.5 x 15.5 x 8.0 inches, with cushioning material that fills the space between the Meter and the sides of the box.

To store the Meter, place the box under cover in a location that complies with the storage environment specifications described in the "General Specifications" section in Chapter 1.

Power Considerations

⚠ ⚠ Warning

To avoid electric shock, connect the Meter's power cord to a power receptacle with earth ground.

The Meter operates on varying power distribution standards found throughout the world and must be set up to operate on the line voltage that will power it. The Meter is packed ready for use with a line voltage determined at the time of ordering. If the selected line voltage does not match the power that the Meter will be plugged into, the line-voltage setting of the Meter must be changed and replacement of the line fuse may be required.

Selecting the Line Voltage

The Meter operates on four different input line voltages. The selected line-voltage setting is visible through the window in the line-fuse holder on the rear panel of the Meter.

1. Unplug the power cord.
2. Insert a small screwdriver blade into the narrow recess to the left of the fuse holder and pry it to the right until the holder pops out. See Figure 2-1.
3. Remove the voltage-selector block from the fuse holder.
4. Rotate the selector block until the desired voltage rating faces outward.
5. Replace the selector block back into the fuse holder.
6. Install the fuse holder back into the Meter and reconnect the power cord.

Changing the line-voltage setting may require a different line-power fuse for proper operation.

Replacing the Fuses

The Meter uses one fuse to protect the line-power input and two fuses to protect the current-measurement inputs.

Line-Power Fuse

The Meter has a line-power fuse in series with the power supply. Table 2-1 indicates the proper fuse for each of the four line-voltage selections. The line-power fuse is accessed through the rear panel.

1. Unplug the power cord.
2. Insert a small screwdriver blade into the narrow recess to the left of the fuse holder and pry it to the right until the holder pops out. See Figure 2-1.
3. Remove the fuse and replace it with a fuse of an appropriate rating for the selected line-power voltage. See Table 2-1.
4. Replace the selector block back into the fuse holder.

⚠ ⚠ Warning

To avoid electric shock or fire, do not use makeshift fuses or short-circuit the fuse holder.

Table 2-1. Line Voltage to Fuse Rating

Line Voltage Selection	Fuse Rating
100 / 120	0.125 A, 250 V (slow blow)
220 / 240	0.063 A, 250 V (slow blow)

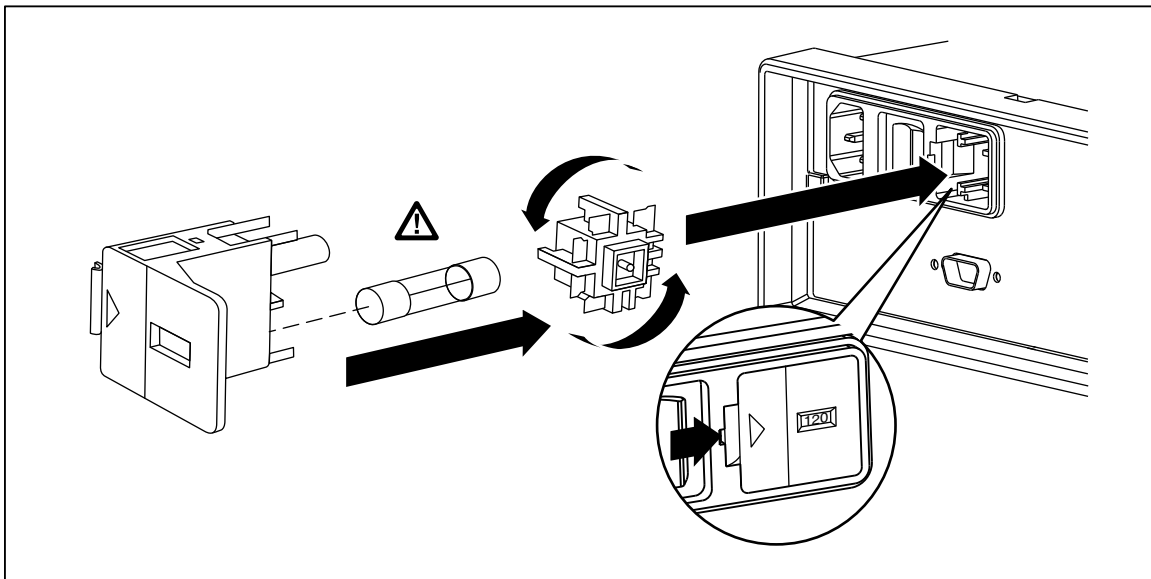

Figure 2-1. Replacing the Line Power Fuse

eue20.eps

Current-Input Fuses



The **200 mA** and **10 A** inputs are protected by user-replaceable fuses.

- The **200 mA** input is protected by a fuse (F2) rated at 440 mA, 1000 V (fast blow), 10,000 A minimum breaking capacity.
- The **10 A** input is protected by a fuse (F1) rated at 11 A, 1000 V (fast blow), 10,000 A minimum breaking capacity.

Warning

For protection against fire or arc flash, replace a blown fuse with a fuse of an identical rating.

To test the current-input fuses:

1. Turn on the Meter and plug a test lead into the **INPUT VΩ**  **HI** terminal.
2. Press .
3. Press  to set the range to 200 Ω. Only the 200 Ω, 2 kΩ, and 20 kΩ ranges can be used to test the mA input fuse.
4. Insert the other end of the test lead into the **mA** terminal. If the fuse is good, the Meter displays a reading of 0.000 Ω. If the fuse is blown, the Meter displays **OL** to indicate an overload.
5. Remove the test lead from the **mA** terminal and insert it into the **10 A** terminal. If the fuse is good, the Meter displays a reading of <1.000 Ω. If the fuse is blown, the Meter displays **OL** to indicate an overload.

Warning

To avoid electric shock, remove the power cord and any test leads from the Meter before opening the current-input fuse cover.

To replace the current-input fuses:

1. Remove power from the Meter by unplugging its power cord.
2. Turn the Meter upside down.
3. Remove the retaining screw on the fuse access door located on the bottom of the Meter. See Figure 2-2.
4. Remove the protective cover from the fuse holders by slightly depressing the back edge of the cover to unlatch it from the printed circuit board. Pull up on the back edge of the cover and remove it from the fuse compartment.
5. Remove the defective fuse and replace it with a fuse of an appropriate rating. See Table 2-1.
6. Replace the protective cover by pushing it over the fuses while aligning the catches with the holes in the printed circuit board. Press the cover down until the catches engage the printed circuit board.
7. Replace the fuse access door and install the retaining screw.

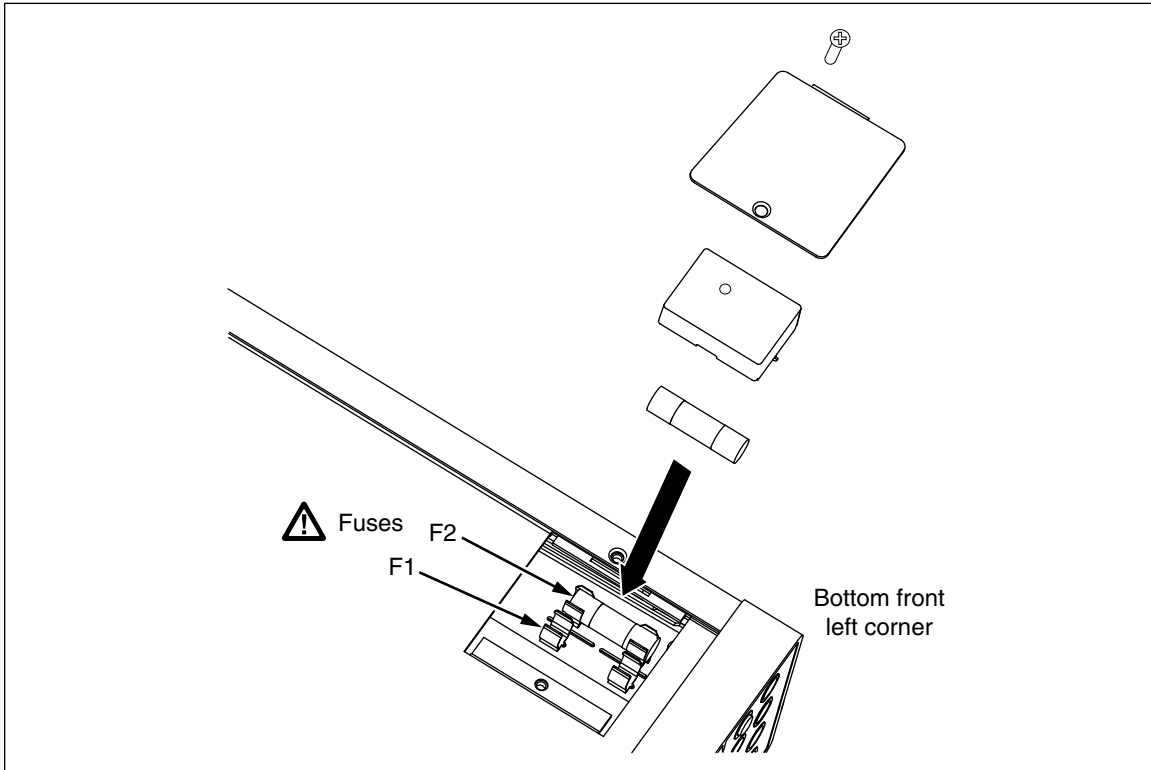

Figure 2-2. Replacing the Current-Input Fuses

If the Meter Does Not Turn On

Use the following steps to help solve problems encountered when turning on the Meter.

1. Verify the power switch is in the “On” position.
2. Make sure that the power cord is firmly plugged into the power module on the rear of the Meter.
3. Make sure the power source the Meter is plugged into is energized.
4. Ensure the power line voltage of the Meter is set to the proper value for your country. See the “Fuse Replacement” section earlier in this chapter for instructions on changing the voltage setting.
5. Verify that the power-line fuse is good.

If these steps don’t solve the problem, then contact Fluke for more help. See the “Contacting Fluke” section in Chapter 4 for contact information.

Display Tests

The display test consists of turning on all the display elements and checking what appears in the display with Figure 2-3. To turn on all the display elements:

1. Turn the Meter on by moving the rear-panel power switch to the “On” position.
2. Put the Meter into standby by pressing the front-panel power button until the display extinguishes.
3. While holding , push in on the front-panel power button until the display illuminates.
4. Check the elements of the display against those elements appearing in Figure 2-3.

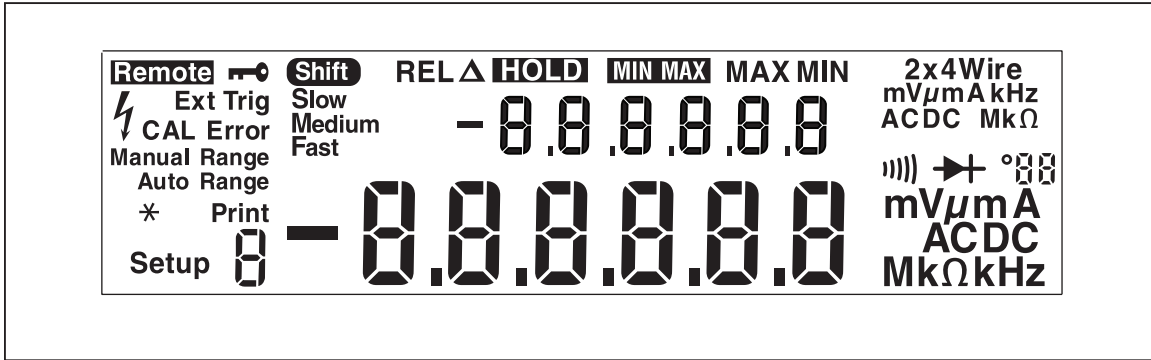

Figure 2-3. Display Elements

ffw008.eps

5. Push the front-panel power button twice to clear the display test.

Chapter 3

Performance Verification and Calibration

Title	Page
Introduction.....	3-3
Required Equipment	3-3
Direct Voltage Verification.....	3-4
Alternating Voltage Verification	3-5
4-Wire Ohms Verification	3-6
2-Wire Ohms Verification	3-7
Direct Current Verification.....	3-8
Alternate Current Verification	3-10
Frequency Verification	3-11
Adjustment (Calibration)	3-11
Equipment for Calibration.....	3-11
Adjustment Process	3-11
Front Panel Adjustments	3-11
RS-232 Calibration (Manual).....	3-16
RS-232 Calibration (Automatic)	3-17
Calibration Points.....	3-17

Introduction

This chapter of the Calibration Manual provides performance tests to verify the Meter is operating within published specifications as well as a complete calibration procedure. The performance test and, if necessary, the calibration procedure can be performed both periodically and after service or repair. A one-year calibration interval is recommended to maintain the accuracy of the Meter.

The performance tests can be used as an acceptance test upon receipt of the Meter. Use the 90-day specifications when performing an acceptance test after performing a calibration.

Required Equipment

Table 3-1 lists the equipment required for performance testing and calibration of the Meter.

Table 3-1. Required Test Equipment

Function	Instrument Type	Model	Comments
Volts dc	Calibrator	Fluke 5700A	Figure 3-1
	4-wire short	Fluke low thermal 4-wire short or equivalent	Fluke PN 2653346
Volts ac	Calibrator	Fluke 5700A	Figure 3-1
	Amplifier	Fluke 5725A	
Resistance	Calibrator	Fluke 5700A	Figures 3-2 & 3-3
Amps dc	Calibrator	Fluke 5700A	Figure 3-4
	Amplifier	Fluke 5725A	Figure 3-5
	4-wire short	Fluke low thermal 4-wire short or equivalent	Fluke PN 2653346
Amps ac	Calibrator	Fluke 5700A	Figure 3-4
	Amplifier	Fluke 5725A	Figure 3-5
Frequency	Function Generator	Fluke 271 or equivalent	Requires frequency specification better than 0.0025 %
Resistance Adjust	Calibrator	Fluke 5520A	Requires resistance accuracy better than 0.0045 %

Direct Voltage Verification

To verify the Volts dc function of the Meter, connect it to the calibrator as shown in Figure 3-1 and apply the voltages listed in Table 3-2,

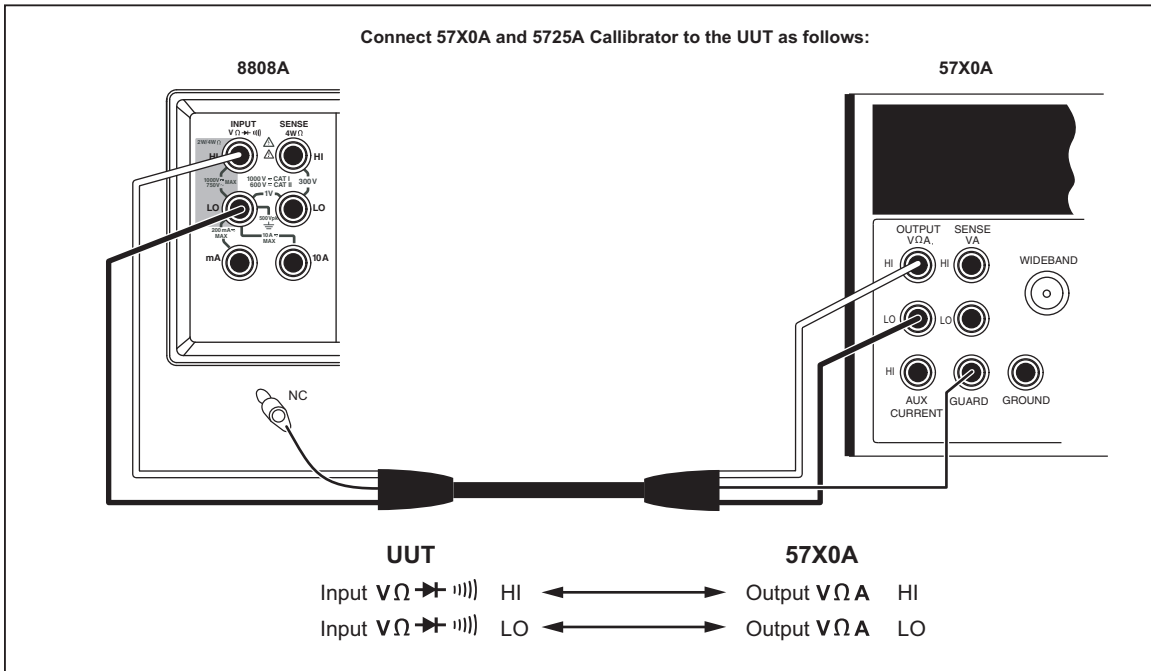

Figure 3-1. Direct and Alternating Voltage Verification Test Setup

Table 3-2. Direct Voltage Verification Steps

Nominal Input	Range	90-Day Test Limit		1-Year Test Limit	
		High	Low	High	Low
0 V	200 mV	0.006 mV	-0.006 mV	0.008 mV	-0.008 mV
190 mV	200 mV	190.025 mV	189.975 mV	190.037 mV	189.964 mV
-190 mV	200 mV	-189.975 mV	-190.025 mV	-189.964 mV	-190.037 mV
0 V	2 V	0.00004 V	-0.00004 V	0.00006 V	-0.00006 V
0.5 V	2 V	0.50009 V	0.49991 V	0.50014 V	0.49986 V
-0.5 V	2 V	-0.49991 V	-0.50009 V	-0.49986 V	-0.50014 V
1.9 V	2 V	1.90023 V	1.89977 V	1.90034 V	1.89966 V
-1.9 V	2 V	-1.89977 V	-1.90023 V	-1.89966 V	-1.90034 V
0 V	20 V	0.0006 V	-0.0006 V	0.0008 V	-0.0008 V
19 V	20 V	19.0025 V	18.9975 V	19.0037 V	18.9963 V
-19 V	20 V	-18.9975 V	-19.0025 V	-18.9963 V	19.0037 V
0 V	200 V	0.004 V	-0.004 V	0.006 V	-0.006 V
190 V	200 V	190.023 V	189.977 V	190.034 V	189.966 V
-190 V	200 V	-189.977 V	-190.023 V	-189.966 V	-190.034 V
0 V	1000 V	0.02 V	-0.02 V	0.03 V	-0.03 V
1000 V	1000 V	1000.12 V	999.88 V	1000.18 V	999.82 V
-1000 V	1000 V	-999.88 V	-1000.12 V	-999.82 V	-1000.18 V

Alternating Voltage Verification

To verify the Volts ac function of the Meter, connect it to the test equipment as shown in Figure 3-1 and apply the voltage listed in Table 3-3.

Table 3-3. Alternating Voltage Verification Steps

Nominal Input		Range	90-Day Test Limit		1-Year Test Limit	
Ampl.	Freq.		High	Low	High	Low
10 mV	50 Hz	200 mV	10.120 mV	9.890 mV	10.120 mV	9.880 mV
190 mV	20 Hz	200 mV	191.620 mV	188.380 mV	191.810 mV	188.190 mV
190 mV	45 Hz	200 mV	190.385 mV	189.615 mV	190.480 mV	189.520 mV
190 mV	20 kHz	200 mV	190.385 mV	189.615 mV	190.480 mV	189.520 mV
190 mV	50 kHz	200 mV	190.670 mV	189.330 mV	190.765 mV	189.235 mV
190 mV	100 kHz	200 mV	191.620 mV	188.380 mV	191.810 mV	188.190 mV
0.1 V	50 Hz	2 V	0.10115 V	0.09885 V	0.10120 V	0.09880 V
1.9 V	20 Hz	2 V	1.91620 V	1.88380 V	1.91810 V	1.88190 V
1.9 V	45 Hz	2 V	1.90385 V	1.89615 V	1.90480 V	1.89520 V
1.9 V	20 kHz	2 V	1.903985 V	1.89615 V	1.90480 V	1.89520 V
1.9 V	50 kHz	2 V	1.90670 V	1.89330 V	1.90765 V	1.89235 V
1.9 V	100 kHz	2 V	1.91620 V	1.88380 V	1.91810 V	1.88190 V
1 V	50 Hz	20 V	1.0115 V	0.9885 V	1.0120 V	0.9880 V
19 V	20 Hz	20 V	19.1620 V	18.8380 V	19.1810 V	18.8190 V
19 V	45 Hz	20 V	19.0385 V	18.9615 V	19.0480 V	18.9520 V
19 V	20 kHz	20 V	19.0385 V	18.9615 V	19.0480 V	18.9520 V
19 V	50 kHz	20 V	19.0670 V	18.9330 V	19.0765 V	18.9235 V
19 V	100 kHz	20 V	19.1620 V	18.8380 V	19.1810 V	18.8190 V
10 V	50 Hz	200 V	10.115 V	9.885 V	10.120 V	9.880 V
190 V	45 Hz	200 V	190.385 V	189.615 V	190.480 V	189.520 V
190 V	20 kHz	200 V	190.39 V	189.62 V	190.480 V	189.520 V
190 V	50 kHz	200 V	190.670 V	189.330 V	190.765 V	189.235 V
190 V	100 kHz	200 V	191.620 V	188.380 V	191.810 V	188.190 V
750 V	50 Hz	30 V	30.42 V	29.58 V	30.44 V	29.57 V
750 V	45 Hz	750 V	751.50 V	748.50 V	751.88 V	748.13 V
750 V	20 kHz	750 V	751.50 V	748.50 V	751.88 V	748.13 V
750 V	50 kHz	750 V	752.63 V	747.48 V	753.00 V	747.00 V
750 V	100 kHz	750 V	756.38 V	743.62 V	757.13 V	742.88 V

4-Wire Ohms Verification

To verify the 4-Wire Ohms function of the Meter, connect it to the test equipment as shown in Figure 3-2 and apply the resistances listed in Table 3-4.

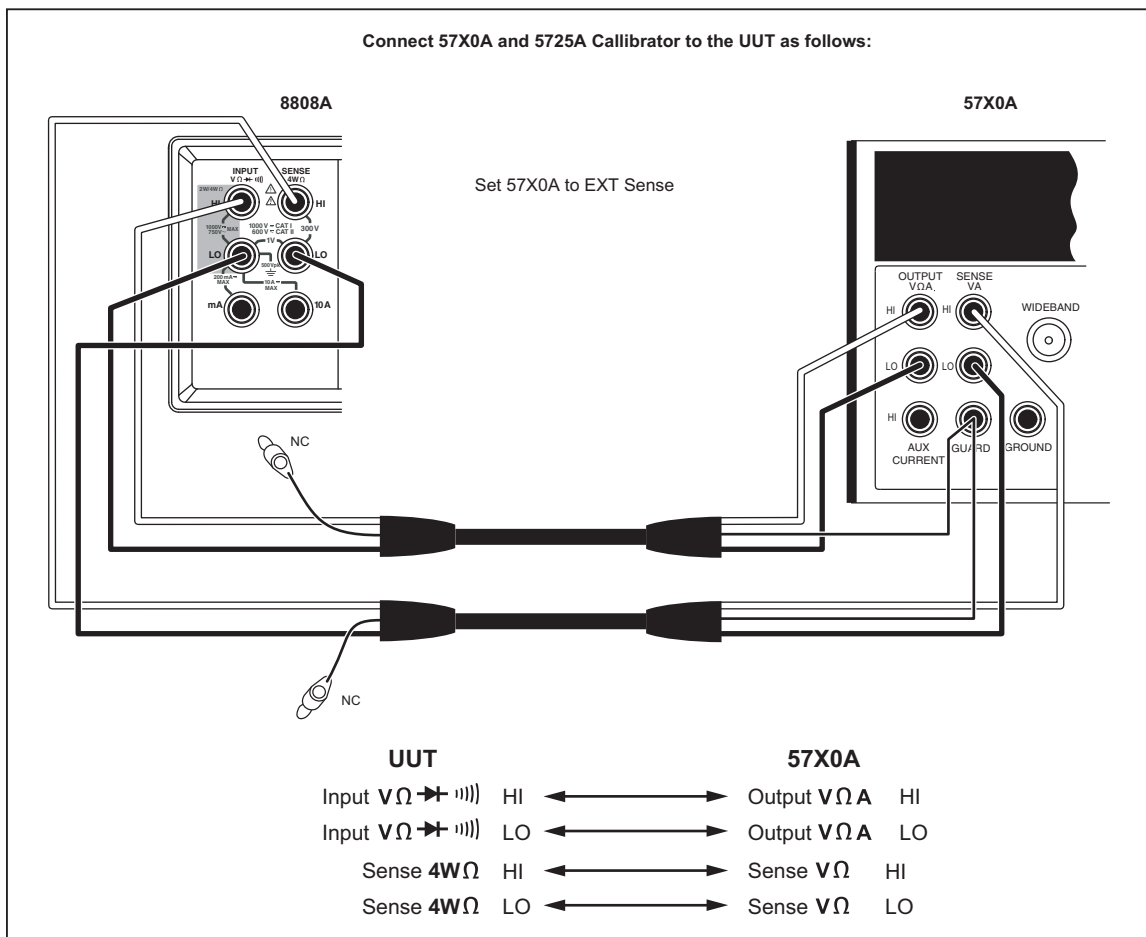

ffw003.eps

Figure 3-2. 4-Wire Ohms Test Setup

Table 3-4. 4-Wire Ohms Verification Steps

Nominal Input	Range	90-Day Test Limit		1-Year Test Limit	
		High	Low	High	Low
0 Ω	200 Ω	0.008 Ω	-0.008 Ω	0.008 Ω	-0.008 Ω
190 Ω	200 Ω	STD+0.046 Ω ^[1]	STD-0.046 Ω ^[1]	STD+0.065 Ω ^[1]	STD-0.065 Ω ^[1]
0 kΩ	2 kΩ	0.00004 kΩ	-0.00004 kΩ	0.00006 kΩ	-0.00006 kΩ
1.9 kΩ	2 kΩ	STD+0.00033 kΩ ^[1]	STD-0.00033 kΩ ^[1]	STD+0.00044 kΩ ^[1]	STD-0.00044 kΩ ^[1]
0 kΩ	20 kΩ	0.0004 kΩ	-0.0004 kΩ	0.0006 kΩ	-0.0006 kΩ
19 kΩ	20 kΩ	STD+0.0033 kΩ ^[1]	STD-0.0033 kΩ ^[1]	STD+0.0044 kΩ ^[1]	STD-0.0044 kΩ ^[1]

[1] 5700 reading + resistance

2-Wire Ohms Verification

To verify the 2-Wire Ohms function of the Meter, connect it to the test equipment as shown in Figure 3-3 and apply the resistances listed in Table 3-5.

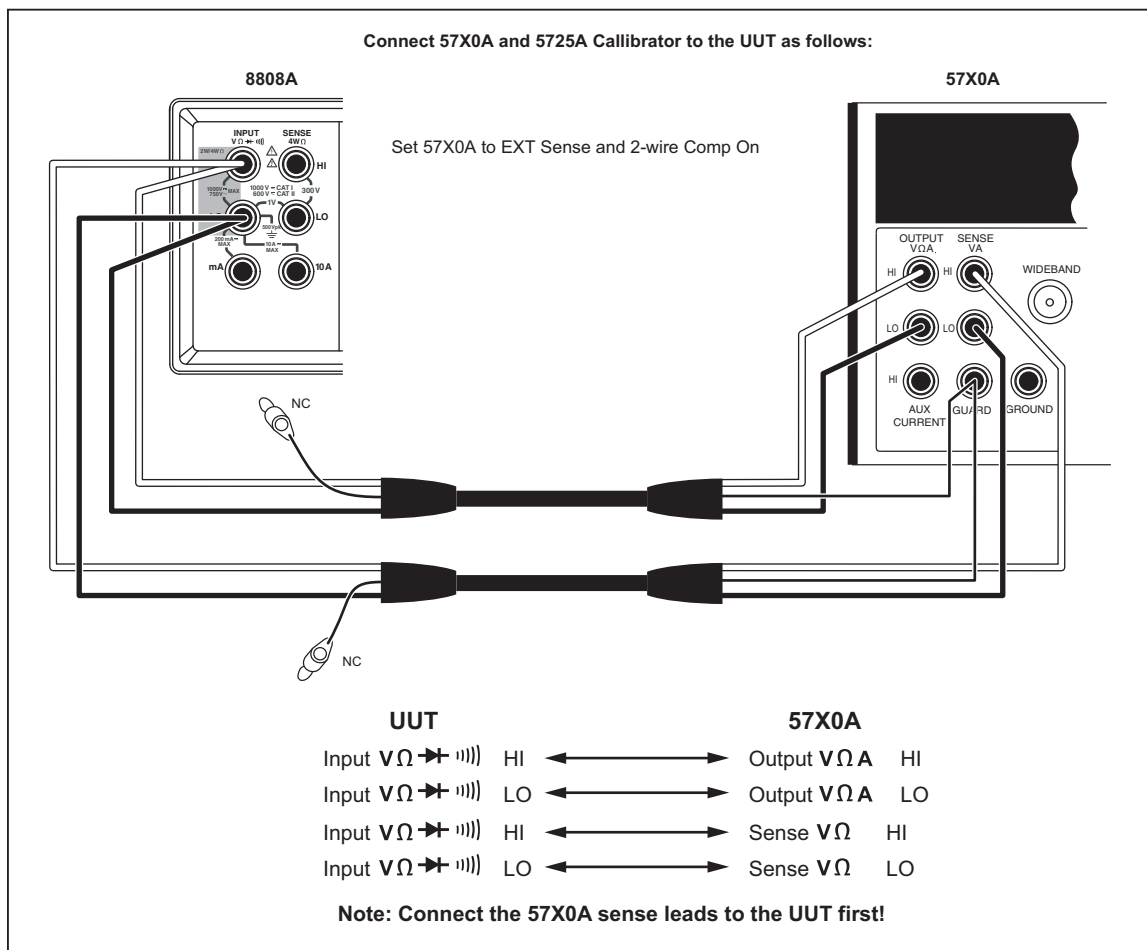

Figure 3-3. 2-Wire Ohms Test Setup

ffw002.eps

Table 3-5. 2-Wire Ohms Verification Steps

Nominal Input	Range	90-Day Test Limit		1-Year Test Limit	
		High	Low	High	Low
0 Ω	200 Ω	0.008 Ω	-0.008 Ω	0.008 Ω	-0.008 Ω
190 Ω	200 Ω	STD+0.046 Ω ^[1]	STD-0.046 Ω ^[1]	STD+0.065 Ω ^[1]	STD-0.065 Ω ^[1]
0 kΩ	2 kΩ	0.00004 kΩ	-0.00004 kΩ	0.00006 kΩ	-0.00006 kΩ
1.9 kΩ	2 kΩ	STD+0.00033 kΩ ^[1]	STD-0.00033 kΩ ^[1]	STD+0.0044 kΩ ^[1]	STD-0.0044 kΩ ^[1]
0 kΩ	20 kΩ	0.0004 kΩ	-0.0004 kΩ	0.0006 kΩ	-0.0006 kΩ
19 kΩ	20 kΩ	STD+0.0033 kΩ ^[1]	STD-0.0033 kΩ ^[1]	STD+0.0044 kΩ ^[1]	STD-0.0044 kΩ ^[1]
0 kΩ	200 kΩ	0.004 kΩ	-0.004 kΩ	0.006 kΩ	-0.006 kΩ
190 kΩ	200 kΩ	STD+0.033 kΩ ^[1]	STD-0.033 kΩ ^[1]	STD+0.044 kΩ ^[1]	STD-0.044 kΩ ^[1]
0 MΩ	2 MΩ	0.00006 MΩ	-0.00006 MΩ	0.00008 MΩ	-0.00008 MΩ

Table 3-5. 2-Wire Ohms Verification Steps (cont.)

Nominal Input	Range	90-Day Test Limit		1-Year Test Limit	
		High	Low	High	Low
1.9 MΩ	2 MΩ	STD+0.00063 MΩ ^[1]	STD-0.00063 MΩ ^[1]	STD+0.00084 MΩ ^[1]	STD-0.00084 MΩ ^[1]
0 MΩ	20 MΩ	0.0006 MΩ	-0.0006 MΩ	0.0006 MΩ	-0.0006 MΩ
19 MΩ	20 MΩ	STD+0.0386 MΩ ^[1]	STD-0.0386 MΩ ^[1]	STD+0.0481 MΩ ^[1]	STD-0.0481 MΩ ^[1]
0 MΩ	100 MΩ	0.004 MΩ	-0.004 MΩ	0.004 MΩ	-0.004 MΩ
100 MΩ	100 MΩ	STD+1.504 MΩ ^[1]	STD-1.504 MΩ ^[1]	STD+1.754 MΩ ^[1]	STD-1.754 MΩ ^[1]

[1] 5700 reading + resistance

Direct Current Verification

To verify the Amps dc function of the Meter, connect it to the test equipment as shown in either Figure 3-4 or Figure 3-5 depending on current level and apply the current levels listed in Table 3-6.

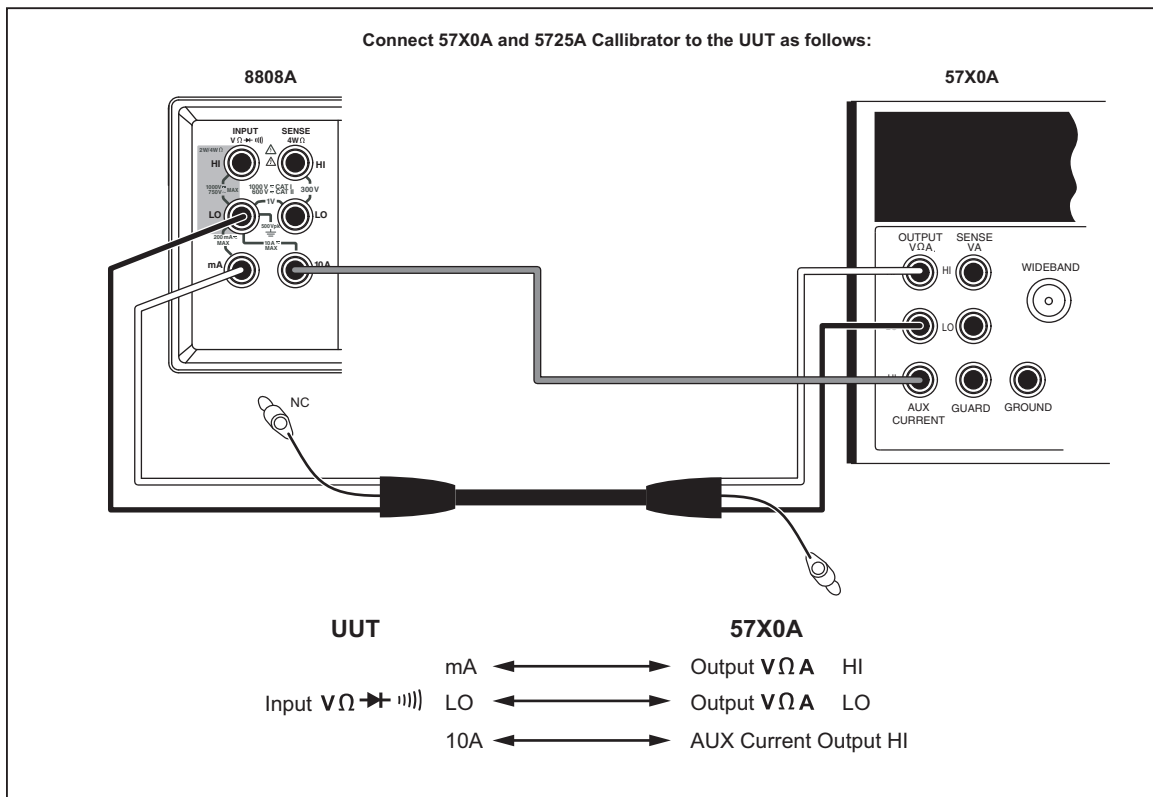
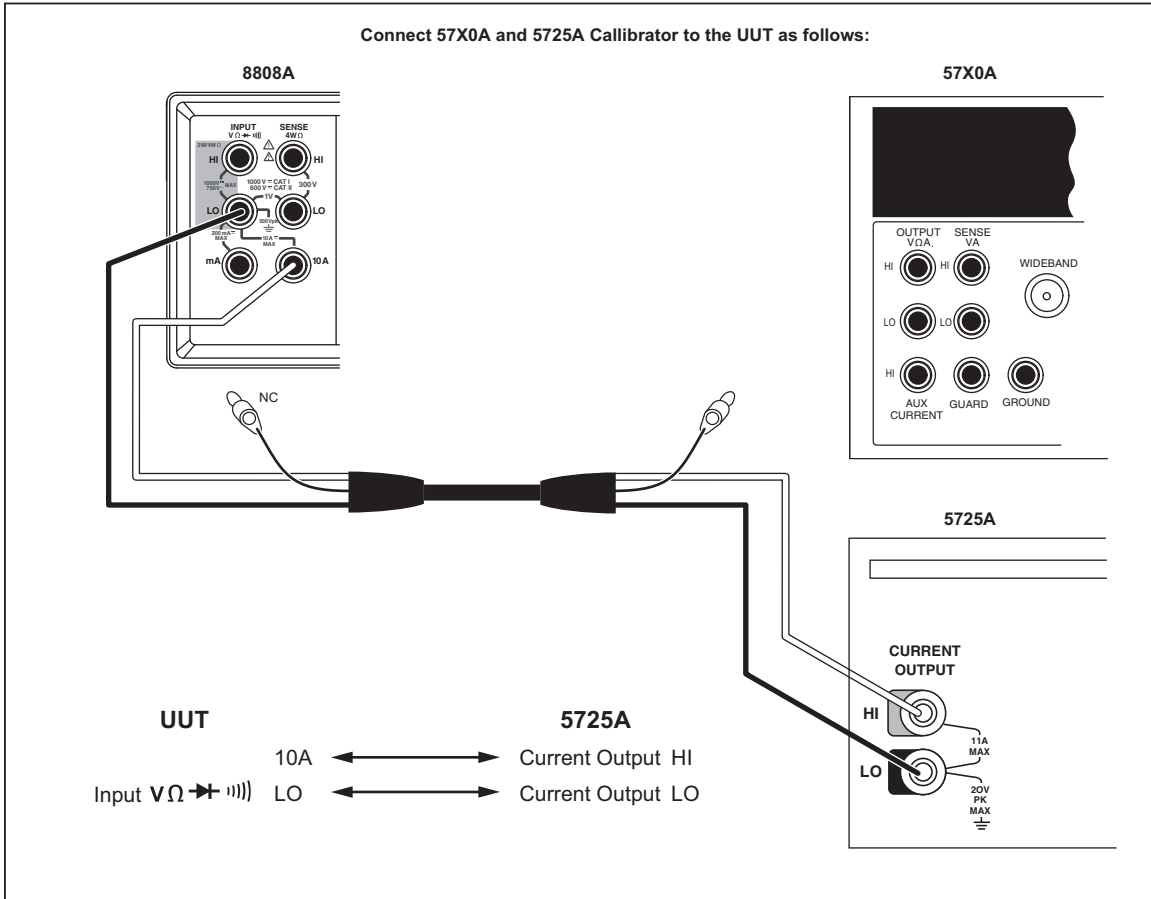

Figure 3-4. Less than 2 Amps Direct and Alternating Current Test Setup

ffw004.eps



ffw005.eps

Figure 3-5. 2 Amps and Greater Direct and Alternating Current Test Setup

Table 3-6. Direct Current Verification Steps

Nominal Input	Range	90-Day Test Limit		1-Year Test Limit	
		High	Low	High	Low
0 μ A	200 μ A	0.010 μ A	-0.010 μ A	0.010 μ A	-0.010 μ A
190 μ A	200 μ A	190.048 μ A	189.952 μ A	190.067 μ A	189.933 μ A
-190 μ A	200 μ A	-189.952 μ A	-190.048 μ A	-189.933 μ A	-190.067 μ A
0 mA	2000 μ A	0.10 μ A	-0.10 μ A	0.10 μ A	-0.10 μ A
1900 μ A	2000 μ A	1900.39 μ A	1899.62 μ A	1900.48 μ A	1899.52 μ A
-1900 μ A	2000 μ A	-1899.62 μ A	-1900.39 μ A	-1899.52 μ A	-1900.48 μ A
0 mA	20 mA	0.0040 mA	-0.0040 mA	0.0040 mA	-0.0040 mA
19 mA	20 mA	19.0097 mA	18.9903 mA	19.0116 mA	18.9884 mA
-19 mA	20 mA	-18.9903 mA	-19.0097 mA	-18.9884 mA	-19.0116 mA
0 mA	200 mA	0.010 mA	-0.010 mA	0.020 mA	-0.020 mA
190 mA	200 mA	190.048 mA	189.952 mA	190.073 mA	189.927 mA
-190 mA	200 mA	-189.952 mA	190.048 mA	-189.927 mA	-190.073 mA

Table 3-6. Direct Current Verification Steps (cont.)

Nominal Input	Range	90-Day Test Limit		1-Year Test Limit	
		High	Low	High	Low
0 A	2 A	0.00040 A	-0.00040 A	0.00040 A	-0.00040 A
1.9 A	2 A	1.90135 A	1.89865 A	1.90192 A	1.89808 A
-1.9 A	2 A	-1.89865 A	-1.90135 A	-1.89808 A	-1.90192 A
0 A	10 A	0.0010 A	-0.0010 A	0.0010 A	-0.0010 A
10 A	10 A	10.0190 A	9.9810 A	10.0210 A	9.9790 A
-10 A	10 A	-9.9810 A	-10.0190 A	-9.9790 A	-10.0210 A

Alternate Current Verification

To verify the Amps ac function of the Meter, connect it to the test equipment as shown in either Figure 3-4 or Figure 3-5 depending on current level and apply the current levels listed in Table 3-7.

Table 3-7. Alternating Current Verification Steps

Nominal Input		Range	90-Day Test Limit		1-Year Test Limit	
Ampl.	Freq.		High	Low	High	Low
1 mA	45 Hz	20 mA	1.0125 mA	0.9875 mA	1.0150 mA	0.9850 mA
19 mA	20 Hz	20 mA	19.2000 mA	18.8000 mA	19.2495 mA	18.7505 mA
19 mA	45 Hz	20 mA	19.058 mA	18.943 mA	19.0690 mA	18.9310 mA
19 mA	2 kHz	20 mA	19.0575 mA	18.9425 mA	19.0690 mA	18.9310 mA
10 mA	45 Hz	200 mA	10.125 mA	9.875 mA	10.150 mA	9.850 mA
190 mA	20 Hz	200 mA	191.620 mA	188.380 mA	192.020 mA	187.980 mA
190 mA	45 Hz	200 mA	190.575 mA	189.425 mA	190.690 mA	189.310 mA
190 mA	2 kHz	200 mA	190.575 mA	189.425 mA	190.690 mA	189.310 mA
0.1 A	45 Hz	2 A	0.10125 A	0.09875 A	0.10150 A	0.09850 A
1.9 A	20 Hz	2 A	1.92000 A	1.88000 A	1.92495 A	1.87505 A
1.9 A	45 Hz	2 A	1.90575 A	1.89425 A	1.90690 A	1.89310 A
1.9 A	2 kHz	2 A	1.90575 A	1.89425 A	1.90690 A	1.89310 A
0.5 A	45 Hz	10 A	0.5118 A	0.4883 A	0.5145 A	0.4855 A
10 A	40 Hz	10 A	10.1100 A	9.8900 A	10.1370 A	9.8630 A
10 A	45 Hz	10 A	10.0450 A	9.9550 A	10.0620 A	9.9380 A
10 A	1 kHz	10 A	10.0450 A	9.9550 A	10.0620 A	9.9380 A

Frequency Verification

Use the function generator to apply the frequencies listed in Table 3-8.

Table 3-8. Frequency Verification Steps

Nominal Input		Range	90-Day Test Limit		1-Year Test Limit	
Ampl.	Freq.		High	Low	High	Low
0.1 V	20 Hz	2000 Hz	20.04 Hz	19.96 Hz	20.06 Hz	19.94 Hz
0.1 V	50 Hz	2000 Hz	50.01 Hz	50.00 Hz	50.01 Hz	50.00 Hz
0.1 V	1900 Hz	2000 Hz	1900.19 Hz	1899.81 Hz	1900.19 Hz	1899.81 Hz
0.1 V	19 kHz	20 kHz	19.0023 Hz	18.9977 Hz	19.0025 Hz	18.9975 Hz
0.1 V	195 kHz	200 kHz	195.024 Hz	194.977 Hz	195.026 Hz	194.975 Hz
0.1 V	1000 kHz	1000 kHz	1000.14 Hz	999.86 Hz	1000.16 Hz	999.84 Hz

Adjustment (Calibration)

Meter adjustments, or calibration, should be performed at the desired interval, or whenever a verification test indicates a Meter function is out of tolerance. The Meter accuracy will stay within specifications only if the adjustment procedure is performed at regular intervals. A one-year interval is adequate for most applications. The Meter's accuracy specifications are not valid beyond the one-year interval.

Equipment for Calibration

The required equipment for calibration is the same as the equipment listed in Table 3-1.

Adjustment Process

The Meter adjustment process can either be managed through the front panel of the Meter or through the RS-232 port. In addition, a completely automated procedure is available as a Fluke Met/Cal program.

Front Panel Adjustments

To put the Meter in the calibration mode, remove the CAL seal and press the Cal Enable button located on the bottom-right side of the front panel with a thin needle. CAL will appear in the secondary display with six flashing dashes in the primary display.

To calibrate a function:

1. Push **ACV**, **ACI**, **DCV**, **DCI**, **FREQ**, or **Ω** to start the calibration process. A recommended calibration value will appear in the primary display and continue to flash until the input is set.

Note

*The recommended value can be overwritten by pushing **COMP** for the + or – sign and **S1** through **S6** for the six digits.*

2. With a stable input to the Meter, push **RANGE** to start calibrating the current calibration point. The displayed value freezes and a flashing star appears in the display. The Meter automatically makes the necessary adjustment to bring the Meter into specification. No internal mechanical adjustments are necessary.

The adjustment steps are divided into six areas by six functions. Table 3-9 lists the calibration steps and indicates the function/command, calibration point, required input signal with frequency, and a description.

Table 3-9. Adjustment Steps

Step	Func./Command	Point	Input Signal	Description
Volts DC: zero points using the 4-wire short				
1	VDC	0 mV/0V	0 mV	Zero point of VDC, all ranges
Volts DC: Gains – Adjust using 5700A/5725A				
2	VDC	-199.9 mV	-199.9 mV	Gain of VDC, 200 mV range
3	VDC	-100 mV	-100 mV	
4	VDC	100 mV	100 mV	
5	VDC	199.9 mV	199.9 mV	
6	VDC	-1.999 V	-1.999 V	Gain of VDC, 2 V range
7	VDC	-1 V	-1 V	
8	VDC	1 V	1 V	
9	VDC	1.999 V	1.999 V	Gain of VDC, 20 V range
10	VDC	-19.99 V	-19.99 V	
11	VDC	-10 V	-10 V	
12	VDC	10 V	10 V	
13	VDC	19.99 V	19.99 V	Gain of VDC, 200 V range
14	VDC	-199.9 V	-199.9 V	
15	VDC	-100 V	-100 V	
16	VDC	100 V	100 V	
17	VDC	199.9 V	199.9 V	Gain of VDC, 1000 V range
18	VDC	-1000 V	-1000 V	
19	VDC	-500 V	-500 V	
20	VDC	500 V	500 V	
21	VDC	1000 V	1000 V	
Volts AC: Zero points – Adjust with 5700A in standby or disconnected				
22	VAC	0 mV/0 V	0 mV	Zero point of VAC, all ranges
Volts AC: Gains – Adjust using 5700A/5725A				
23	VAC	10 mV	10 mV@1 kHz	Gain of VAC, 200 mV range
24	VAC	100 mV	100 mV@1 kHz	
25	VAC	150 mV	150 mV@1 kHz	
26	VAC	199.9 mV	199.9 mV@1 kHz	
27	VAC	0.1 V	0.1 V@1 kHz	Gain of VAC, 2 V range
28	VAC	1 V	1 V@1 kHz	
29	VAC	1.5 V	1.5 V@1 kHz	
30	VAC	1.999 V	1.999 V@1 kHz	

Table 3-9. Adjustment Steps (cont.)

Step	Func./Command	Point	Input Signal	Description
31	VAC	1 V	1 V@1 kHz	Gain of VAC, 20 V range
32	VAC	10 V	10 V@1 kHz	
33	VAC	15 V	15 V@1 kHz	
34	VAC	19.99 V	19.99 V@1 kHz	
35	VAC	10 V	10 V@1 kHz	Gain of VAC, 200 V range
36	VAC	100 V	100 V@1 kHz	
37	VAC	150 V	150 V@1 kHz	
38	VAC	199.9 V	199.9 V@1 kHz	
39	VAC	37.5 V	37.5 V@1 kHz	Gain of VAC, 750 V range
40	VAC	200 V	200 V@1 kHz	
41	VAC	500 V	500 V@1 kHz	
42	VAC	750 V	750 V@1 kHz	
Frequency – Adjust using 5520A				
43	FREQ	500 Hz	1.9 V@500 Hz	Frequency
44	FREQ	1 kHz	1.9 V@1 kHz	
45	FREQ	1.5 kHz	1.9 V@1.5 kHz	
46	FREQ	5 kHz	1.9 V@5 kHz	
47	FREQ	10 kHz	1.9 V@10 kHz	
48	FREQ	15 kHz	1.9 V@15 kHz	
49	FREQ	50 kHz	1.9 V@50 kHz	
50	FREQ	100 kHz	1.9 V@100 kHz	
51	FREQ	150 kHz	1.9 V@150 kHz	
52	FREQ	250 kHz	1.9 V@250 kHz	
53	FREQ	500 kHz	1.9 V@500 kHz	
54	FREQ	750 kHz	1.9 V@750 kHz	
Ohms – Adjust using 5520A				
55	OHMS	0 Ω	0 Ω, 4Wire	Zero point of OHMS, 200 Ω range
56	OHMS	50 Ω	50 Ω, 4Wire	Gain of OHMS, 200 Ω range
57	OHMS	100 Ω	100 Ω, 4Wire	
58	OHMS	150 Ω	150 Ω, 4Wire	
59	OHMS	1 Ω	1 Ω, 4Wire	Gain of OHMS, 2 kΩ range
60	OHMS	0.5 kΩ	0.5 kΩ, 4Wire	
61	OHMS	1 kΩ	1 kΩ, 4Wire	
62	OHMS	1.5 kΩ	1.5 kΩ, 4Wire	

Table 3-9. Adjustment Steps (cont.)

Step	Func./Command	Point	Input Signal	Description
63	OHMS	10 Ω	10 Ω , 4Wire	Gain of OHMS, 20 k Ω range
64	OHMS	5 k Ω	5k Ω , 4Wire	
65	OHMS	10 k Ω	10 k Ω , 4Wire	
66	OHMS	15 k Ω	15 k Ω , 4Wire	
67	OHMS	100 Ω	100 Ω , 2Wire	Gain of OHMS, 200 k Ω range
68	OHMS	50 k Ω	50 k Ω , 2Wire	
69	OHMS	100 k Ω	100 k Ω , 2Wire	
70	OHMS	150 k Ω	150 k Ω , 2Wire	
71	OHMS	1 k Ω	1 k Ω , 2Wire	Gain of OHMS, 2 M Ω range
72	OHMS	0.5 M Ω	0.5 M Ω , 2Wire	
73	OHMS	1 M Ω	1 M Ω , 2Wire	
74	OHMS	1.5 M Ω	1.5 M Ω , 2Wire	
75	OHMS	10 k Ω	10 k Ω , 2Wire	Gain of OHMS, 20 M Ω range
76	OHMS	5 M Ω	5 M Ω , 2Wire	
77	OHMS	10 M Ω	10 M Ω , 2Wire	
78	OHMS	15 M Ω	15 M Ω , 2Wire	
79	OHMS	100 k Ω	100 k Ω , 2Wire	Gain of OHMS, 100 M Ω range
80	OHMS	20 M Ω	20 M Ω , 2Wire	
81	OHMS	50 M Ω	50 M Ω , 2Wire	
82	OHMS	100 M Ω	100 M Ω , 2Wire	
Current AC: zero points – Adjust using 5700A/5725A				
83	AAC	0 mA/0 A	Open, no connection	Zero point of AAC, all ranges
Current AC: Gains – Adjust using 5700A/5725A				
84	AAC	1 mA	1 mA@500 Hz	Gain of AAC, 20 mA range
85	AAC	5 mA	5 mA@500 Hz	
86	AAC	10 mA	10 mA@500 Hz	
87	AAC	19.99 mA	19.99 mA@500 Hz	
88	AAC	10 mA	10 mA@500 Hz	Gain of AAC, 200 mA range
89	AAC	50 mA	50 mA@500 Hz	
90	AAC	100 mA	100 mA@500 Hz	
91	AAC	199.9 mA	199.9 mA@500 Hz	
92	AAC	0.1 A	0.1 A@500 Hz	Gain of AAC, 2 A range
93	AAC	0.5 A	0.5 A@500 Hz	
94	AAC	1 A	1 A@500 Hz	
95	AAC	1.999 A	1.999 A@500 Hz	

Table 3-9. Adjustment Steps (cont.)

Step	Func./Command	Point	Input Signal	Description
96	AAC	0.5 A	0.5 A@500 Hz	Gain of AAC, 10 A range
97	AAC	2 A	2 A@500 Hz	
98	AAC	5 A	5 A@500 Hz	
99	AAC	10 A	10 A@500 Hz	
Current DC: zero points – Adjust with 5700A in standby or disconnected				
100	ADC	0 μ A/0 mA/0 A	Open, no connection	Zero point of ADC, all ranges
Current DC: Gains – Adjust using 5700A/5725A				
101	ADC	-199.9 μ A	-199.9 μ A	Gain of ADC, 200 μ A range, need characterize 5520A with 8508A
102	ADC	-100 μ A	-100 μ A	
103	ADC	100 μ A	100 μ A	
104	ADC	199.9 μ A	199.9 μ A	
105	ADC	-1999 μ A	-1999 μ A	Gain of ADC, 2000 μ A range, need characterize 5520A with 8508A
106	ADC	-1000 μ A	-1000 μ A	
107	ADC	1000 μ A	1000 μ A	
108	ADC	1999 μ A	1999 μ A	
109	ADC	-19.99 mA	-19.99 mA	Gain of ADC, 20 mA range
110	ADC	-10 mA	-10 mA	
111	ADC	10 mA	10 mA	
112	ADC	19.99 mA	19.99 mA	
113	ADC	-199.9 mA	-199.9 mA	Gain of ADC, 200 mA range, need characterize 5520A with 8508A
114	ADC	-100 mA	-100 mA	
115	ADC	100 mA	100 mA	
116	ADC	199.9 mA	199.9 mA	
117	ADC	-1.999 A	-1.999 A	Gain of ADC, 2 A range, need characterize 5520A with 8508A@ \pm 1.999 A
118	ADC	-1 A	-1 A	
119	ADC	1 A	1 A	
120	ADC	1.999 A	1.999 A	
121	ADC	-10 A	-10 A	Gain of ADC, 10 A range
122	ADC	-5 A	-5 A	
123	ADC	5 A	5 A	
124	ADC	10 A	10 A	

When the calibration point finishes calibration and another calibration point is part of the selected function, a new recommended calibration value will be displayed automatically. Input the proper signal and repeat step 2 above.

When the last calibration point for the selected function finishes, the Meter will go to IDLE mode where CAL appears in the secondary display and six flashing dashes appear

in the primary display. Return to step 1 above and select the next function for calibration. Press  to exit the calibration mode at any time. If a function has not been completely calibrated, a CAL ERROR will be displayed.

Note

When 4WIRE shows in the display, 4-wire compensation is enabled on the input.

Note

When in current calibration, if ZERO point is calibrated all test leads shall be removed. Use the mA input terminal for low current range (1, 2, 3, and 4 for ADC and 1 or 2 for AAC). Use the 10A input terminal for high current range (5 or 6 for ADC and 3 or 4 for AAC).

Note

Set the calibrator to 1.9 volts for frequency calibration input.

RS-232 Calibration (Manual)

A manual calibration of the Meter is possible by typing commands through the RS-232 port from a PC and making manual adjustments of the test equipment. To use the RS-232 port to calibrate the Meter, connect a PC to the Meter using a null-modem cable. Set the PC in the Hyper Terminal mode to enable communication between the PC and the Meter.

Note

All commands should be ASCII codes.

Enable calibration by sending “*TER” to the Meter. The Meter will return “Select a Function or input EXIT to QUIT!”.

1. Send “VDC”, “VAC”, “ADC”, “AAC”, “OHMS”, or “FREQ” to the Meter to select the function you want to calibrate. The Meter will return “XXXXXX V, 0 HZ” where XXXXXX is the recommended calibration value. The value also shows in the Meter display.

Note

The recommended value can be overwritten by sending the Meter a new value as “CALREF XXXXXX”. If the value is acceptable “=>” will be returned, otherwise “!>” will be returned.

2. Push the “Enter” key to confirm the calibration value.
3. With a stable input to the Meter, push the “Enter” key to start calibrating the current calibration point. The Meter will return the string “WAIT...” while calibrating.

When the calibration point finishes calibration and another calibration point is part of the selected function, a new recommended calibration value is sent automatically. Input the proper signal and repeat step 3 above.

Note

Once a function is selected for calibration, all calibration points must be calibrated before exiting the calibration process. Otherwise a CALL ERROR will show in the display.

When the last calibration point for the selected function finishes, the Meter will go to IDLE mode and the Meter will send the string “Select a Function or input EXIT to QUIT!”. Return to step 1 above and select the next function for calibration.

Send the string “EXIT” to exit the calibration mode at any time. If a function has not been completely calibrated, a CAL ERROR will be displayed.

Note

When the Meter returns a recommended calibration value followed by “W4”, 4-wire compensation is enabled on the input.

Note

When in current calibration, if “Disconnect Test Leads!” is returned, all test leads should be removed from the Meter.

Note

When “Connect to mA socket!” is returned from the Meter, use the mA input terminal to connect to the calibrator. When “Connect to 10A socket” is returned from the Meter, use the 10A input terminal to connect to the calibrator.

RS-232 Calibration (Automatic)

Automatic calibration of the Meter is possible using a Fluke Met/Cal program. The remote program directs the calibration equipment to apply a series of shorts, opens, voltages, currents, and resistances to the input of the Meter. At each step, the Meter internally makes the necessary adjustment to bring the Meter into specification. No internal mechanical adjustments are necessary.

Using an automated, computer-controlled procedure, the calibration and verification procedures can be performed on the Meter in less than 50 minutes. The 8808A MET/CAL procedure is available at no charge for MET/CAL Gold Support members from <http://support.fluke.com/met-support-gold>. To purchase the procedure, contact Fluke’s MET/CAL Support group at metsupport@fluke.com.

Calibration Points

Listed below are the calibration values required for each calibration point of the calibration procedure.

```
{//adc
  {0.0, -0.0001999, -0.0001, 0.0001, 0.0001999}, range 1
  {0.0, -0.001999, -0.001, 0.001, 0.001999}, range 2
  {0.0, -0.01999, -0.01, 0.01, 0.01999}, range 3
  {0.0, -0.1999, -0.1, 0.1, 0.1999}, range 4
  {0.0, -1.999, -1.0, 1.0, 1.999}, range 5
  {0.0, -10.0, -5.0, 5.0, 10.0}, range 6
},
{//aac
  {0.0, 0.001, 0.005, 0.01, 0.01999}, range 1
  {0.0, 0.01, 0.05, 0.1, 0.1999}, range 2
  {0.0, 0.01, 0.5, 1.0, 1.999}, range 3
  {0.0, 1.0, 2.0, 5.0, 10.0}, range 4
},
```

```
{//vdc
  {0.0, -0.1999, -0.1, 0.1, 0.1999},      range 1
  {0.0, -1.999, -1.0, 1.0, 1.999},      range 2
  {0.0, -19.990, -10.0, 10.0, 19.990},   range 3
  {0.0, -199.90, -100.0, 100.0, 199.9},  range 4
  {0.0, -1000.0, -500.0, 500.0, 1000.0}, range 5
},
{//vac
  {0.0, 0.05, 0.10, 0.15, 0.1999},      range 1
  {0.0, 0.5, 1.0, 1.5, 1.999},         range 2
  {0.0, 5.0, 10.0, 15.0, 19.99},       range 3
  {0.0, 50.0, 100.0, 150.0, 199.9},    range 4
  {0.0, 100.0, 200.0, 500.0, 750.0},    range 5
},
{//ohm
  {0.0, 0.5E+2, 1.0E+2, 1.5E+2},       range 1
  {1.0, 0.5E+3, 1.0E+3, 1.5E+3},       range 2
  {10.0, 0.5E+4, 1.0E+4, 1.5E+4},      range 3
  {100.0, 0.5E+5, 1.0E+5, 1.5E+5},     range 4
  {1000.0, 0.5E+6, 1.0E+6, 1.5E+6},    range 5
  {10000.0, 0.5E+7, 1.0E+7, 1.5E+7},   range 6
  {1.0E+5, 0.2E+8, 0.5E+8, 1.0E+8},    range 7
},
{//hz
  {500, 1000, 1500},                    range 1
  {5000, 10000, 15000},                 range 2
  {50000, 100000, 150000},              range 3
  {250000, 500000, 750000},             range 4
},
```

Chapter 4
List of Replaceable Parts

Title	Page
Introduction.....	4-3
How to Obtain Parts.....	4-3
How to Contact Fluke.....	4-3
Parts Lists.....	4-4

Introduction

This chapter contains an illustrated list of replaceable parts for the Fluke 8808A Digital Multimeter. Parts are listed by assembly and alphabetized by reference designator. Each assembly is accompanied by an illustration showing the location of each part and its reference designator. The parts lists provide the following information:

- Reference designator
- Description
- Fluke stock number
- Total quantity
- Any special notes (i.e., factory-selected part)

How to Obtain Parts

Electrical components may be ordered directly from the manufacturer by using the manufacturer's part number, or from the Fluke Corporation and its authorized representatives by using the part number under the heading Part Number.

Parts price information is available from the Fluke Corporation or its representatives. Prices are also available in a Fluke Replacement Parts Catalog, which is available on request.

In the event that the part ordered has been replaced by a new or improved part, the replacement will be accompanied by an explanatory note and if necessary, installation instructions.

To ensure prompt delivery of the correct part, include the following information when you place an order:

- Instrument model and serial number
- Part number and revision level of the pca containing the part.
- Reference designator
- Fluke stock number
- Description (as given under the DESCRIPTION heading)
- Quantity

How to Contact Fluke

To contact Fluke, call one of the following telephone numbers:

- Technical Support USA: 1-800-99-FLUKE (1-800-993-5853)
- Calibration/Repair USA: 1-888-99-FLUKE (1-888-993-5853)
- Canada: 1-800-36-FLUKE (1-800-363-5853)
- Europe: +31 402-675-200
- Japan: +81-3-3434-0181
- Singapore: +65-738-5655
- Anywhere in the world: +1-425-446-5500

Or, visit Fluke's website at www.fluke.com.

Parts Lists

Tables 4-1 and 4-2 lists the replaceable parts for the Meter. Figures 4-1 and 4-2 identify the parts within the Meter.

Table 4-1. Front-Panel Assembly

Ref. Desig.	Description	Part Number	Qty
A1	FLUKE-8808-4002, FLUKE-8808-4002, PCA, DISPLAY/KEYPAD	2536097	1
F1	FUSE, 11A, 1000V, FAST.406INX1.5IN, BULK	803293	1
F2	FUSE, .440A, 1000V, FAST, .406X1.375, BULK	943121	1
H1	SCREW, 6-32, .250, PAN, PHILLIPS, STEEL, ZINC-CLEAR, LOCK	152140	4
H2	SCREW, 8-32, .250, PAN, PHILLIPS, STEEL, ZINC-CLEAR, LOCK	228890	4
H3	SCREW ,SCREW,FHU,P,LOCK,MAG SS,6-32,.250	320093	5
H4	SCREW, SCREW, WH, P, THD FORM, STL, 5-20,.312	494641	3
MP1	8845A-2009, REAR BOOT	2439161	1
MP10	FLUKE-8808A-8001, KEYPAD	2570286	1
MP11	FLUKE-8808A-2001, FRONT PANEL	2570247	1
MP12	8808A-2003, LENS	2570264	1
MP13	FLUKE-8808A-8002, FRONT PANEL DECAL	2570299	1
MP2	8845A-2001, TOP COVER	2439097	1
MP3	FLUKE-8808A-2005, WEDGE	2634240	1
MP4	8845A-2008, HANDLE	2439150	1
MP5	8845A-2010, FRONT BOOT	2439177	1
MP6	8808A, LABEL, CALIBRATION	3077525	1
MP7	FLUKE 867-8008, LABEL, CALIBRATION	948674	1
MP8	8845A-2020, FUSE DOOR	2439239	1
MP9	FLUKE 27-2002 ,COVER, FUSE	665031	1

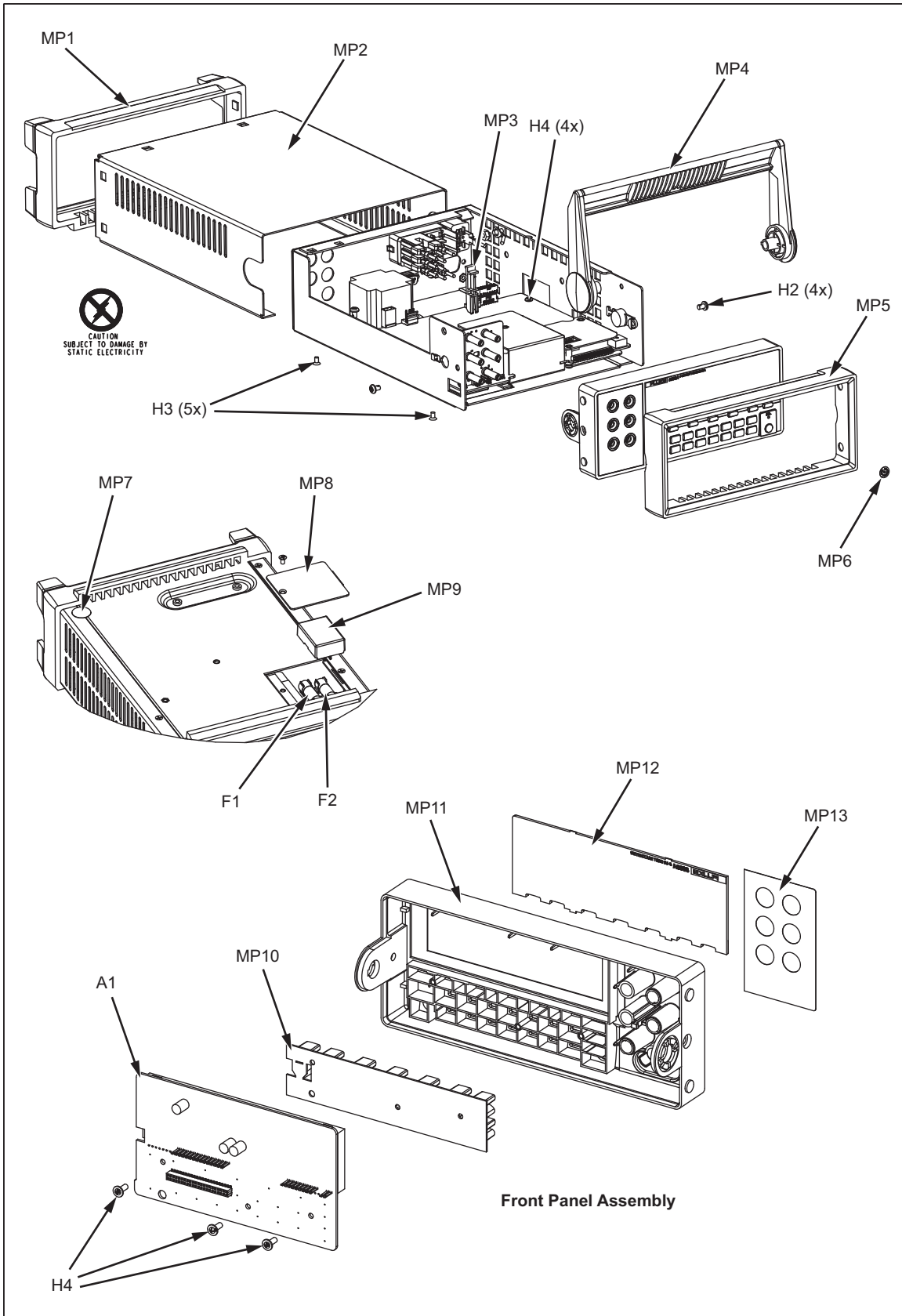
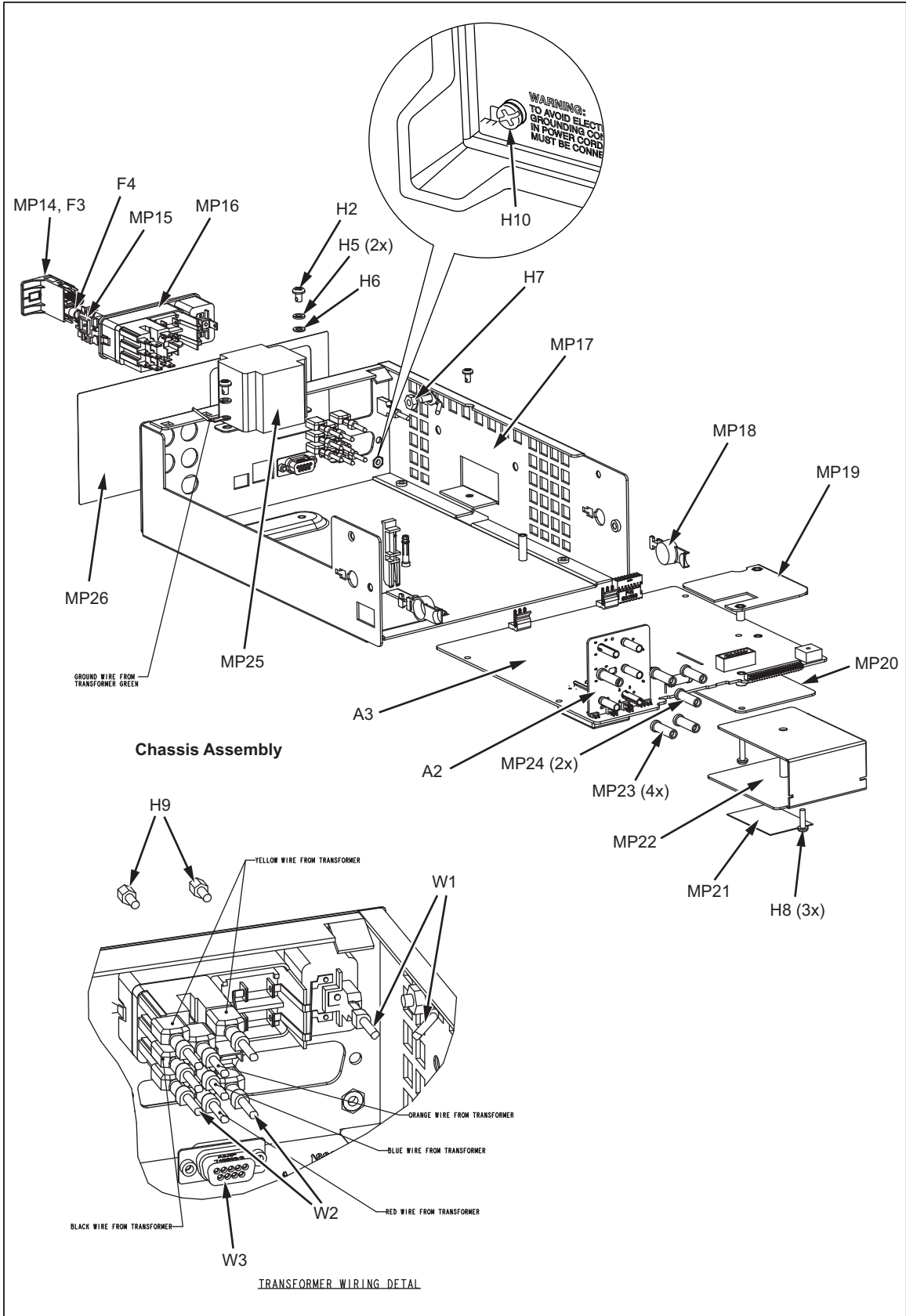

Figure 4-1. Front-Panel Assembly

ffw006.eps

Table 4-2. Chassis Assembly

Ref. Desig.	Description	Part Number	Qty
A2	FLUKE-8808-4003,FLUKE-8808-4003, PCA, INPUT	2536106	1
A3	FLUKE-8808-4001,FLUKE-8808-4001, PCA, MAIN	2536085	1
F3	FUSE, FUSE, .25X1.25, 0.125A, 250V, SLOW	166488	1
F4	FUSE, FUSE, .25X1.25, 0.063A, 250V, SLOW	163030	1
H10	SCREW, 6-32, .250, PAN, SLOT/PHILLIPS COMBO, STEEL,ZINC-CHROMATE	855192	1
H5	WASHER, WASHER, LOCK, SPLIT, STL, .168, .307, .040	111070	2
H6	WASHER, WASHER, FLAT, STL, .170, .375, .031	110288	1
H7	NUT, NUT, EXT LOCK, STL, 8-32	195263	1
H8	SCREW, PH, P, LOCK, SS, 6-32, .500	320051	3
H9	CONNECTOR ACCESSORY, D-SUB JACK SCREW, 4-40, .250 L, W/FLAT WASHER	1777348	2
LC1	LINE CORD, CN, 10A, 250V, PSB-10-1, ESB-10, 227 IEC, RVV 300/500, 980MM (Not shown)	2716592	1
MP14	FILTER PART, FILTER, LINE, PART, FUSE DRWR W/SHRT BAR	944277	1
MP15	FILTER PART, FILTER, LINE, PART, VOLTAGE SELECTOR	944272	1
MP16	POWER ENTRY MODULE, KG10.6101.105, AC INLET, ON/OFF LINE SWITCH, FUSE DRAWER,BULK	2437071	1
MP17	8808A-2004, CHASSIS	2570273	1
MP18	8845A-2027, HANDLE CAP, PLASTIC PART	2663315	1
MP19	SHIELD CRYSTAL TOP	3184555	1
MP20	SHIELD CRYSTAL BOTTOM	3184562	1
MP21	INSULATOR, .020 INCH THICK	3237934	1
MP22	FLUKE-8008A-2007, SHIELD, AC	3024921	1
MP23	FLUKE 45-2010-03 ,INSULATOR,INPUT RECEPTACLE (RED)	884254	4
MP24	FLUKE 45-2010-04 ,INSULATOR,INPUT RECEPTACLE (BLACK)	884259	2
MP25	TRANSFORMER,POWER,100/120/220/240V,50/60HZ,18V CT,9W,8808A,BULK	2716605	1
MP26	8808A-8003,REAR PANEL DECAL	2726188	1
TL1	TEST LEAD SET, 600V/1KV, PROBE-R/A PLUG, BLACK/RED (Not shown)	802980	1
TM1	GETTING STARTED, GUIDE, 8808A (Not shown)	2716412	1
TM2	CD-ROM, PROGRAMMER AND USERS MANUAL (Not shown)	2713002	1
W1	2620A-4403, WIRE ASSY,GROUND	874099	1
W2	8845A-4402, WIRE ASSY	2584378	1
W3	CABLE ASSEMBLY, 6 COND, DB9(M), RECEPTACLE, 5.00 L	2734791	1



ffw007.eps

Figure 4-2. Chassis Assembly

