

RPM4™
Reference Pressure Monitor
Operation and Maintenance Manual



High pressure liquids and gases are potentially hazardous. Energy stored in these liquids and gases can be released unexpectedly and with extreme force. High pressure systems should be assembled and operated only by personnel who have been instructed in proper safety practices.



This instrument is not to be operated in any other manner than that specified by the manufacturer.

© 2004-2007 DH Instruments, a Fluke Company All rights reserved.

Information in this document is subject to change without notice. No part of this document may be reproduced or transmitted in any form or by any means, electronic or mechanical, for any purpose, without the express written permission of **DH Instruments, a Fluke Company** 4765 East Beautiful Lane, Phoenix AZ 85044-5318, USA.

DH Instruments makes sincere efforts to ensure accuracy and quality of its' published materials; however, no warranty, expressed or implied, is provided. **DH Instruments** disclaims any responsibility or liability for any direct or indirect damages resulting from the use of the information in this manual or products described in it. Mention of any product or brand does not constitute an endorsement by **DH Instruments** of that product or brand. This manual was originally composed in English and was subsequently translated into other languages. The fidelity of the translation cannot be guaranteed. In case of conflict between the English version and other language versions, the English version predominates.

Products described in this manual are manufactured under international patents and one or more of the following U.S. patents: 5,142,483; 5,257,640; 5,331,838; 5,445,035. Other U.S. and international patents pending.

AutoRange, AutoZ, **DH Instruments**, **DH**, **DHI**, CalTool, COMPASS, RPM4, QDUT, Q-RPT, RPM4 and SDS are trademarks, registered and otherwise, of **DH Instruments, a Fluke Company**.

Document No. 550129a-03
050815
Printed in the USA.

TABLE OF CONTENTS



TABLE OF CONTENTS	I
TABLES	V
FIGURES.....	VI
ABOUT THIS MANUAL	VII
1. INTRODUCTION	1
1.1 PRODUCT OVERVIEW	1
1.2 SPECIFICATIONS	2
1.2.1 GENERAL SPECIFICATIONS	2
1.2.2 PRESSURE MEASUREMENT SPECIFICATIONS.....	2
1.2.2.1 QUARTZ REFERENCE PRESSURE TRANSDUCER (Q-RPT)	2
1.2.2.2 ON-BOARD BAROMETER	4
1.2.3 BATTERY AND CHARGER PACK.....	5
2. INSTALLATION	7
2.1 UNPACKING AND INSPECTION	7
2.1.1 REMOVING FROM PACKAGING.....	7
2.1.2 INSPECTING CONTENTS.....	7
2.2 SITE REQUIREMENTS.....	8
2.3 SETUP	8
2.3.1 PREPARING FOR OPERATION	8
2.3.2 FRONT AND REAR PANELS.....	8
2.3.2.1 FRONT PANEL	8
2.3.2.2 REAR PANEL.....	9
2.3.3 POWER CONNECTION.....	9
2.3.3.1 85 TO 264 VAC, 50/60 HZ VAC POWER	9
2.3.3.2 BATTERY PACK	9
2.3.4 REMOTE [ENT] CONNECTION (FOOTSWITCH OR OTHER SWITCH).....	10
2.3.5 CONNECTING TO MEASURE PRESSURE (TEST(+) AND TEST(-) PORTS).....	10
2.3.6 THE VENT OR ATM PORT	11
2.3.7 CHECK/SET SECURITY LEVEL	11
2.3.8 TURN OFF ABSOLUTE AND NEGATIVE GAUGE MODE (AXXX RPT).....	12
2.3.9 SDS FULL TIME OFF	12
2.3.10 PARALLEL MEASUREMENT MODE.....	12
2.4 POWER-UP AND VERIFICATION.....	12
2.4.1 SWITCH POWER ON	12
2.4.2 CHECK PRESSURE MEASUREMENT OPERATION.....	13
2.4.2.1 CHECKING ABSOLUTE MODE PRESSURE MEASUREMENT.....	13
2.4.2.2 CHECKING GAUGE MODE PRESSURE MEASUREMENT	13
2.5 SHORT TERM STORAGE.....	14
3. OPERATION	15
3.1 USER INTERFACE	15
3.1.1 MAIN RUN SCREEN.....	15
3.1.2 FUNCTION / DATA KEYPAD LAYOUT AND PROTOCOL.....	17
3.1.3 REMOTE [ENT] (ENTER) FOOTSWITCH.....	18
3.1.4 SOUNDS	18
3.2 GENERAL OPERATING PRINCIPLES	18
3.2.1 PRESSURE READY/NOT READY	18

3.2.2	GAUGE AND NEGATIVE GAUGE MODES WITH AN AXXX (ABSOLUTE) Q-RPT, DYNAMIC COMPENSATION FOR ATMOSPHERIC PRESSURE	19
3.2.3	MULTIPE RANGES (Q-RPTS, AUTORANGE AND INFINITE RANGING)	20
3.2.4	PARALLEL MEASUREMENT MODE	21
3.2.5	USING RPM4 WITH A PPC3 CONTROLLER/CALIBRATOR	21
3.2.6	USE OF THE 12VDC BATTERY/CHARGER PACK	23
3.2.7	SDS SELF DEFENSE SYSTEM	24
3.2.8	DIRECT FUNCTION KEYS SUMMARY	25
3.3	DIRECT FUNCTION KEYS	25
3.3.1	[RANGE]	25
3.3.2	[UNIT]	26
3.3.3	[MODE]	27
3.3.3.1	DIFFERENTIAL MEASUREMENT MODE OPERATION	29
3.3.4	[AUTORANGE]	30
3.3.5	[LEAK CK]	33
3.3.6	[DISPLAY]	34
3.3.6.1	AVG (AVERAGE)	36
3.3.6.2	RATE	37
3.3.6.3	DEV (DEVIATION)	38
3.3.6.4	RPT	39
3.3.6.5	HI/LO	40
3.3.6.6	FREEZE	41
3.3.6.7	CLEAN	41
3.3.7	[HEAD]	42
3.3.8	[SDS] (SELF DEFENSE SYSTEM)	43
3.3.8.1	SDS IN DIFFERENTIAL AND PARALLEL MEASUREMENT MODES	46
3.3.9	[AUTOZ]	46
3.3.9.1	[AUTOZ] IN GAUGE AND NEGATIVE GAUGE MODE	47
3.3.9.2	[AUTOZ] IN ABSOLUTE MODE	48
3.3.9.3	AUTOZ IN DIFFERENTIAL MODE	51
3.3.10	[ENT] (RUN AUTOTEST)	51
3.4	[SETUP]	52
3.4.1	<1RANGE>	52
3.4.1.1	SAVING AN AUTORANGE RANGE	52
3.4.1.2	DELETING AUTORANGE RANGES	53
3.4.2	<2RES> (RESOLUTION)	53
3.4.3	<3STAB>	54
3.4.4	<4UL> (UPPER LIMIT)	55
3.4.4.1	OVER PRESSURE FUNCTION	57
3.4.5	<5ATEST>	57
3.5	[SPECIAL]	57
3.5.1	<1AUTOZ>	58
3.5.1.1	EDIT AUTOZ	62
3.5.2	<2REMOTE>	62
3.5.2.1	<1COM1, 2COM2>	63
3.5.2.2	<3IEEE-488>	63
3.5.2.3	<4FORMAT>	63
3.5.2.4	<5RS232 SELF-TEST>	64
3.5.3	<3HEAD>	64
3.5.4	<4SDS>	65
3.5.4.1	<1TEMP OPEN/CLOSE>	65
3.5.4.2	<2FULL TIME ON/OFF>	66
3.5.5	<5PREFS>	66
3.5.5.1	<1SCRSVR>	67
3.5.5.2	<2SOUND>	67
3.5.5.3	<3TIME>	67
3.5.5.4	<4ID>	68
3.5.5.5	<5LEVEL> (SECURITY)	68
3.5.6	<6PUNIT>	71
3.5.7	<7INTERNAL>	73
3.5.7.1	<1BARO>	73
3.5.7.2	<2READRT>	74
3.5.7.3	<3RPT2X>	75
3.5.7.4	<4LO VNT>	76
3.5.7.5	<5LOG>	77
3.5.8	<8CAL>	77
3.5.9	<9RESET>	78
3.5.9.1	<1SETS>	78
3.5.9.2	<2 UNITS>	79
3.5.9.3	<3ATEST>	79
3.5.9.4	<4 CAL>	79
3.5.9.5	<5 ALL>	80

4.	REMOTE OPERATION	81
4.1	OVERVIEW	81
4.2	INTERFACING	81
4.2.1	RS232 INTERFACE	81
4.2.1.1	COM1	81
4.2.1.2	IEEE-488	82
4.2.1.3	COM2	82
4.3	PROGRAMMING FORMATS	82
4.3.1	CLASSIC PROGRAM MESSAGE FORMAT	83
4.3.2	ENHANCED PROGRAM MESSAGE FORMAT	83
4.3.2.1	USING COMMAND TYPE COMMANDS	83
4.3.2.2	USING QUERY TYPE COMMANDS	84
4.4	COMMANDS	85
4.4.1	PROGRAMMING MESSAGES	85
4.4.2	ERROR MESSAGESS	86
4.4.3	PROGRAM MESSAGE DESCRIPTION OVERVIEW	87
4.4.4	PROGRAM MESSAGE DESCRIPTIONS	88
4.5	STATUS REPORTING SYSTEM	108
4.5.1	ERROR QUEUE	108
4.5.2	STATUS BYTE REGISTER	108
4.5.3	STANDARD EVENT REGISTER	110
4.5.4	READY STATUS REGISTER	110
4.6	IEEE STD. 488.2 COMMON AND STATUS PROGRAM MESSAGES	111
4.6.1	PROGRAM MESSAGE DESCRIPTIONS	112
5.	MAINTENANCE, ADJUSTMENTS AND CALIBRATION	115
5.1	OVERVIEW	115
5.2	CALIBRATION OF QUARTZ REFERENCE PRESSURE TRANSDUCERS (Q-RPTS)	115
5.2.1	PRINCIPLE	115
5.2.1.1	PA AND PM COEFFICIENTS	116
5.2.1.2	AS RECEIVED AND AS LEFT DATA	116
5.2.2	EQUIPMENT REQUIRED	117
5.2.2.1	GAS OPERATED Q-RPTS, A10M AND LOWER	117
5.2.2.2	OIL OR GAS OPERATED Q-RPTS A14M AND HIGHER	117
5.2.3	SET-UP AND PREPARATION	118
5.2.4	RECOMMENDED CALIBRATION POINT SEQUENCE	119
5.2.4.1	STANDARD CLASS Q-RPTS	119
5.2.4.2	PREMIUM CLASS Q-RPTS	120
5.2.5	TURNING OFF ABSOLUTE AND NEGATIVE GAUGE MEASUREMENT MODES FOR AXXX (ABSOLUTE) Q-RPTS	122
5.2.6	Q-RPT CALIBRATION USING CALTOOL FOR RPTS SOFTWARE	122
5.2.7	EDITING AND VIEWING Q-RPT CALIBRATION INFORMATION	122
5.2.8	Q-RPT CALIBRATION/ADJUSTMENT WITHOUT CALTOOL FOR RPTS SOFTWARE	124
5.3	ADJUSTMENT OF ON-BOARD BAROMETER	125
5.4	RELOADING EMBEDDED SOFTWARE INTO FLASH MEMORY	126
5.5	SUBASSEMBLY DESCRIPTION AND LOCATION	127
5.5.1	MINI MICRO BOARD	127
5.5.2	POWER SUPPLY MODULE	127
5.5.3	DRIVER BOARD	128
5.5.4	ON-BOARD BAROMETER	128
5.5.5	Q-RPT MODULE	128
5.5.5.1	HI Q-RPT MODULE	128
5.5.5.2	LO Q-RPT MODULE	128
5.5.6	DISPLAY	128
5.6	Q-RPT MODULE PNEUMATIC SCHEMATICS	129

6. TROUBLESHOOTING	131
7. APPENDIX	135
7.1 REMOTE [ENT]	135
7.2 UNIT CONVERSION	136
7.2.1 PRESSURE.....	136
8. WARRANTY	137
8.1 OVERVIEW	137
9. GLOSSARY	139

TABLES



Table 1. Reference Pressure Transducer (Q-RPT) Module Designations and Ranges	3
Table 2. RPM4 Packing List.....	7
Table 3. Position Designators of Q-RPTs in an RPM4 System.....	20
Table 4. Settings and What They Are Specific To (Range, Measurement Mode, Q-RPT, System)	21
Table 5. Summary of RPM4 Function Key Operation.....	25
Table 6. Settings Made by AutoRange	31
Table 7. AutoZ ON and OFF	60
Table 8. Security Levels.....	70
Table 9. UNIT Function - Available Units of Measure.....	72
Table 10. READRT - Display Update Rates	74
Table 11. Reset – Sets.....	79
Table 12. Reset – Cal	80
Table 13. Reset – All.....	80
Table 14. COM1 Pin Designations and Connections	81
Table 15. COM2 DB-9F Pin Designations	82
Table 16. Program Message List.....	85
Table 17. Error #s and Descriptions	86
Table 18. 8 Bit Status Byte Register	108
Table 19. 8 Bit Standard Event Register.....	110
Table 20. 8 Bit Ready Status Register.....	110
Table 21. Program Message List.....	111
Table 22. Calibration Point Sequence, Standard Class, Axxx and Gxxx Q-RPTs	119
Table 23. Calibration Point Sequence, Standard Class, BGxxx Q-RPTs.....	120
Table 24. Calibration Point Sequence, Standard Class, BA100K Q-RPT.....	120
Table 25. Calibration Point Sequence, Premium Class, Axxx and Gxxx Q-RPTs	121
Table 26. Calibration Point Sequence, Premium Class, BGxxx Q-RPTs.....	121
Table 27. Troubleshooting Guide.....	131
Table 28. Pressure Unit of Measure Conversion Coefficients.....	136
Table 29. DHI Authorized Service Providers	137



FIGURES

Figure 1. Front Panel	8
Figure 2. Rear Panel	9
Figure 3. MAIN RUN Screen Display Fields	16
Figure 4. Keypad Layout	17
Figure 5. Battery Pack/Charger	23
Figure 6. Status Register Schematic	109
Figure 7. Internal View	127
Figure 8. Pneumatic/hydraulic schematics of RPM4 with Single Q-RPT Module	129
Figure 9. Pneumatic/hydraulic schematics of RPM4 with Two Q-RPT Modules	130
Figure 10. Remote [ENT] Connector Schematic	135

ABOUT THIS MANUAL



This manual is intended to provide the user with the basic information necessary to operate an RPM4 reference pressure monitor. It also includes a great deal of additional information provided to allow you to optimize RPM4 use and take full advantage of its many features and functions.



RPM4-AD is a special air data configuration of RPM4 which has its own dedicated manual, p/n 550148. This manual is for all other configurations of RPM4. If you are using an RPM4-AD ("-AD" in front panel configuration window) use the RPM4-AD Operation and Maintenance Manual p/n 550148.

Before using the manual, take a moment to familiarize yourself with the Table of Contents structure: Sections 1, 2 and 3 should be read by all first time RPM4 users. Section 3 is most important for those using the local front panel interface but should be read over by all users to familiarize themselves with general RPM4 operating principles. Section 4 is for remote operation from an external computer. Section 5 provides maintenance and calibration information. Section 6 is a quick troubleshooting guide. Use it to troubleshoot unexpected RPM4 behavior based on the symptom of that behavior. Certain words and expressions have specific meaning as they pertain to RPM4. The Glossary, Section 6, is useful as a quick reference for exact definition of specific words and expressions as they are used in the manual.



For those of you who "don't read manuals", go directly to Section 2.3 to set up your RPM4 and then go to Section 2.4 for power-up and verification. This will get you up and running quickly with a minimal risk of causing damage to yourself or your new RPM4. THEN... when you have questions or start to wonder about all the great features you might be missing, get into the manual!

Manual Conventions



(CAUTION) is used in throughout the manual to identify user warnings and cautions.



(NOTE) is used throughout the manual to identify operating and applications advice and additional explanations.

[] indicates direct function keys (e.g., [RANGE]).
< > indicates RPM4 screen displays (e.g., <1yes>).

NOTES



1. INTRODUCTION

1.1 PRODUCT OVERVIEW

RPM4 is a stand-alone, microprocessor driven, reference pressure monitor intended to precisely measure gas or liquid pressure in a wide variety of pressure calibration, measurement and testing applications. It has been designed to provide very high performance and extensive features combined with maximum versatility and ease of use.

RPM4 uses one or two quartz reference pressure transducer (Q-RPT) modules and, in some cases a barometer, to measure pressure.

RPM4 can be controlled locally by the operator using its front panel display and keypad or remotely by a computer using ASCII character command strings transmitted over its standard RS232 or IEEE-488.2 interface.

RPM4 models are available in ranges from as low as - 3 to 3 kPa (0.4 psi) to as high as 280 MPa (40 000 psi) in absolute, gauge, compound gauge and differential measurement modes.

RPM4 can be integrated into a PPC3 Pressure Controller/Calibrator System to serve the PPC3's external pressure measuring reference (see the PPC3 Operation and Maintenance Manual).



A special configuration of RPM4 designated RPM4-AD is available for air data (altitude and airspeed) applications. The RPM4-AD model has its own specific manual p/n 550148.

1.2 SPECIFICATIONS

1.2.1 GENERAL SPECIFICATIONS

Power Requirements	85 to 264 VAC, 50/60 Hz, 25 VA max consumption and 12VDC, 1.2 A		
Operating Temperature Range	15 to 35 °C		
Storage Temperature Range	- 20 to 70 °C		
Vibration	Meets MIL-T-28800D		
Ventilation	To prevent product overheating, provide proper ventilation. Allow 10 cm (4 in.) clearance from rear panel cooling fan.		
Weight	5 kg (11 lb) approx. (varies slightly with number and type of Q-RPT modules)		
Dimensions	10 cm H x 22.7 cm W x 24 cm D (3.9 in. x 9.3 in. x 9.5 in.)		
Microprocessors	Motorola 68302, 16 MHz		
Communication Ports	RS232 (COM1, COM2), IEEE-488.2		
Fuses	1 A, 250 VAC fuse, 5 x 20 mm, time lag type fuse		
	Internal power supply fuse not replaceable by operator: 2.5A, 250 VAC		
Pressure Ranges	One or two independent quartz reference pressure transducer (Q-RPT) modules cover vacuum to 280 MPa (40 000 psi)		
Operating Medium	Any clean, dry, non-corrosive gas or liquid. Q-RPTs less than 7 MPa full scale, gas only		
Pressure Connections		Q-RPTs up to A70M	Q-RPTs > A70M
	TEST(+):	1/8 in. NPT F	DH500 F
	TEST(-):	1/8 in. NPT F	None
	VENT or ATM:	10-32 UNF (VENT)	10-32 UNF (ATM)



DH500 is a gland and collar type fitting for 6mm (1/4 in.) coned and left hand threaded tubes equivalent to AE F250C, HIP HF4, etc.

Self Defense System (SDS™)	Included on all gas operated Q-RPT modules of A7M or lower. Isolates Q-RPT module TEST(+) port and vents it to atmosphere. SDS is not included with liquid filled Q-RPTs.		
Pressure Limits	Maximum Working Pressure:	104 % Q-RPT maximum	
	Maximum Pressure Without Damage:	125 % Q-RPT maximum	
	Maximum SDS Protection Pressure:	10 MPa (1 500 psi)	
	Without Damage:	13 MPa (2 000 psi)	
CE Mark	Available, must be specified		

1.2.2 PRESSURE MEASUREMENT SPECIFICATIONS

1.2.2.1 QUARTZ REFERENCE PRESSURE TRANSDUCER (Q-RPT)

RPM4 can be configured with one or two quartz reference pressure transducer (Q-RPT) modules to measure pressure. The type (Axxx, Gxxx, BGxxx, BAxxx) and range of the Q-RPT module(s) determines the RPM4 measurement specifications.

All Q-RPTs whose maximum pressure is over 200 kPa (30 psi) are of the absolute pressure type (Axxx) using an evacuated, permanently sealed reference. Axxx Q-RPTs can measure absolute, gauge and negative gauge pressure. Gauge pressure with an Axxx Q-RPT is defined by offsetting atmospheric pressure and applying dynamic compensation for atmospheric changes using the on-board barometer (see Section 3.2.2). Gxxx (gauge) Q-RPTs can measure positive gauge pressure only. BGxxx (bi-directional gauge) Q-RPTs can measure gauge and negative gauge pressure. See Section 3.3.3 for additional information on absolute, gauge and negative gauge measurement modes.

RPM4s configured with two Q-RPT modules have independent **TEST** ports and can measure separately. Two Q-RPTs can also be used together to operate in differential mode (see Section 3.3.3.1) and parallel mode (see Section 3.2.4).



Q-RPTs of A10M and lower are available with two different performance levels, STANDARD class and PREMIUM class. See the product label on the RPM4 rear panel, the Q-RPT module label on the rear panel and/or the product calibration reports to determine the class of the Q-RPT(s) installed in RPM4.

Table 1. Reference Pressure Transducer (Q-RPT) Module Designations and Ranges

Q-RPT DESIGNATION	SI VERSION		US VERSION	
	MAXIMUM RANGE [kPa]	MAXIMUM RANGE [kPa]	MAXIMUM RANGE [psi]	MAXIMUM RANGE [psi]
	Absolute	Gauge	Absolute	Gauge
A280M-L ¹	280 000	280 000	40 000	40 000
A200M-L ¹	200 000	200 000	30 000	30 000
A140M-L ¹	140 000	140 000	20 000	20 000
A100M-L ¹	100 000	100 000	15 000	15 000
A70M ¹	70 000	70 000	10 000	10 000
A40M ¹	40 000	40 000	6 000	6 000
A20M ¹	20 000	20 000	3 000	3 000
A14M ¹	14 000	14 000	2 000	2 000
A10M ¹	10 000	10 000	1 500	1 500
A7M ¹	7 000	7 000	1 000	1 000
A3.5M ¹	3 500	3 500	500	500
A2M ¹	2 000	2 000	300	300
A1.4M ¹	1 400	1 400	200	200
A700K ¹	700	700	100	100
A350K ¹	350	250	50	35
A200K ¹	200	100	30	15
A160K ¹	160	60	23	8
A100K ¹	110	10	16	1.5
BA100K ⁴	110	--	16	--
G200K ²	--	200	--	30
G100K ²	--	100	--	15
G15K ²	--	15	--	2.2
BG15K ³	--	±15	--	± 2.2

1. All AXXXX RPTs support absolute, gauge and compound (negative) gauge modes.
2. All GXXXX RPTs are positive gauge mode only.
3. BG15K is bi-directional gauge from - 15 to + 15 kPa (- 2.2 to + 2.2 psi).
4. BA100K is a barometric range whose low point is 70 kPa absolute (10 psi).

Warm Up Time	30 minute temperature stabilization recommended from cold power up.
Resolution	To 1 ppm, user adjustable
Compensated Temperature Range	5 to 35 °C
Acceleration Affect	± 0.008 % /g maximum, worst axis Allows operation at ± 20° from reference plane without significant effect
Predicted One Year Stability (all classes and types) ¹	± 0.005% of reading

Q-RPTs UP TO A10M (1500 psi)

	FULL SCALE CLASS (RPM4-LP ONLY)	STANDARD CLASS	PREMIUM CLASS
Precision²	± 0.01% of AutoRanged span, or 0.3 Pa, whichever is greater	± 0.008% of reading or 0.0024% of Q-RPT span, whichever is greater ⁴	± 0.005% of reading, 0.0015% of AutoRanged span, or 0.0005% of Q-RPT span, whichever is greater ⁵
Measurement Uncertainty³	± .015% of AutoRanged span, or 0.375 Pa, whichever is greater	± 0.01% of reading or 0.0030% of Q-RPT span, whichever is greater ⁴	± 0.008 % of reading, 0.0024% of AutoRanged span, or 0.0007% of Q-RPT span, whichever is greater ⁵

Q-RPTs A14M TO A140M (2 000 to 20 000 psi)

Precision²	± 0.012% of reading or 0.0036% of Q-RPT span, whichever is greater ⁴
Measurement Uncertainty³	± 0.013% of reading or 0.0039% of Q-RPT span, whichever is greater ⁴

Q-RPTs A200M TO A280M (30 000 to 40 000 psi)

Precision²	± 0.015% of reading or 0.0045% of Q-RPT span, whichever is greater ⁴
Measurement Uncertainty³	± 0.018% of reading or 0.0054% of Q-RPT span, whichever is greater ⁴

1. Predicted Q-RPT measurement stability limit (k=2) over one year assuming regular use of AutoZero function. AutoZero occurs automatically in gauge mode whenever vented, by comparison with barometric reference in absolute mode. Absolute mode predicted one year stability without AutoZ is ± (0.005 % Q-RPT span + 0.005 % of reading).
2. Combined linearity, hysteresis, repeatability. Add + 1 Pa (0.00015 psi) in gauge mode with an Axxx (absolute) Q-RPT for the resolution and short term stability of the on-board barometer.
3. Maximum deviation of the Q-RPT indication from the true value of applied pressure including precision, predicted one year stability limit, temperature effect and calibration uncertainty, combined and expanded (k=2) following the ISO "Guide to the Expression of Uncertainty in Measurement."
4. % of reading value times measured pressure from 100 to 30 % of Q-RPT span. Under 30 % of Q-RPT span, % of reading value times 30 % of Q-RPT span. For example, if the Q-RPT is a Standard A160K, the Measurement Uncertainty in pressure is 0.010% times the measured pressure to 48 kPa (160 kPa span x 30%) and 0.0048 kPa (160 kPa span x 30% x 0.01%) under 48 kPa.
5. % of reading value times measured pressure from 100 to 30 % of AutoRanged span. Under 30% of AutoRanged span, % of reading value times 30% of AutoRanged span. If AutoRanged span is less than 30% of maximum Q-RPT span, % of reading values times measured pressure, or % of reading times 9% of Q-RPT span, whichever is greater. For example, if the Q-RPT is a Premium A160K and AutoRanged span is 160 kPa, the Measurement Uncertainty in pressure is measured pressure x 0.008% to 48 kPa (160 kPa AutoRanged span x 30%) and 0.0038 kPa (160 kPa span x 30% x 0.008%) under 48 kPa. If the AutoRanged span is 100 kPa (greater than 30% of 160 kPa maximum Q-RPT span), the Measurement Uncertainty in pressure is measured pressure x 0.008% to 30 kPa (100 kPa AutoRanged span x 30%) and 0.0025 kPa (100 kPa span x 30% x 0.008%) under 30 kPa. If the AutoRanged span is 30 kPa (less than 30% of the 160 kPa maximum Q-RPT span), the Measurement Uncertainty in pressure is measured pressure x 0.008% to 14.4 kPa (160 kPa maximum Q-RPT span x 9%) and 0.0012 kPa (160 kPa maximum Q-RPT span x 9% x 0.008%) under 14.4 kPa.

1.2.2.2 ON-BOARD BAROMETER

The on-board barometer is used only to measure changes in atmospheric pressure to provide dynamic compensation of the Q-RPT's atmospheric pressure offset when using an Axxx (absolute) Q-RPT to make gauge pressure measurements and for line pressure compensation of G15K and BG15K Q-RPTs.



There is no on-board barometer in RPM4s that have G100K or G200K Q-RPTs only".

1.2.3 BATTERY AND CHARGER PACK

Power Requirements	100 to 240 VAC, 50/60 Hz, 15 W max consumption
Operating Temperature Range	0 to 50 °C
Storage Temperature Range	- 20 to 50 °C
Vibration	Meets MIL-T-28800D
Weight	2 kg (4.4 lb)
Dimensions	8 cm H x 22.5 cm W x 20 cm D (3.1 in. x 8.9 in. x 7.9 in.)
Battery Type	Nickel Metal-Hydride
Battery Voltage	12 VDC
Battery Capacity	Typical: 9000 mAh Min: 8200 mAh
Charge Time	Full charge from empty, 14 to 16 hours approx.
Approx. Run Time, Full Charge	8 to 12 hours

NOTES



2. INSTALLATION

2.1 UNPACKING AND INSPECTION

2.1.1 REMOVING FROM PACKAGING

RPM4 is delivered in a corrugated container with polyethylene inserts to hold it in place; or in the optional molded, medium density polyethylene shipping case with a custom foam insert for holding the RPM4.

Remove the RPM4 and its accessories from the shipping container and remove each element from its protective plastic bag.

2.1.2 INSPECTING CONTENTS

Check that all items are present and have no visible damage.

A standard RPM4 includes all items indicated in Table 2.

Table 2. RPM4 Packing List

DESCRIPTION		PART #
1 ea.	RPM4 Reference Pressure Monitor	FAM008
1 ea.	Calibration Report	550100
ACCESSORIES:		401967 (401967-CE)
1 ea.	Operation and Maintenance Manual	550129
1 ea.	Power Cord (7.5 ft.)	100770 (100770-CE)
1 ea.	Ferrite sleeve (snap on to COM2 cable for CE)	103303
1 ea.	General Accessories Disk (white CD)	102987
OPTIONAL BATTERY/CHARGER PACK		401904 (401904-CE)
1 ea.	Battery/charger pack	401980
1 ea.	Battery/charger pack to RPM4 cable	401979
1 ea.	Power Cord (7.5 ft.)	100770 (100770-CE)
1 ea.	Instruction Sheet	560062

2.2 SITE REQUIREMENTS

Install RPM4 on a flat, stable surface at a convenient height. The front feet can be extended so that the unit can be inclined for easier viewing. The RPM4 can also be mounted in a standard 19 in. rack mount using the optional rack mount kit.

2.3 SETUP

2.3.1 PREPARING FOR OPERATION

To prepare RPM4 for check out and operation:

- 1 Remove the plastic caps from the RPM4 rear panel pressure connections.
- 2 Remove the protective plastic sheet from the front panel display.
- 3 Familiarize yourself briefly with the front and rear panels (see Section 2.3.2).

2.3.2 FRONT AND REAR PANELS

2.3.2.1 FRONT PANEL

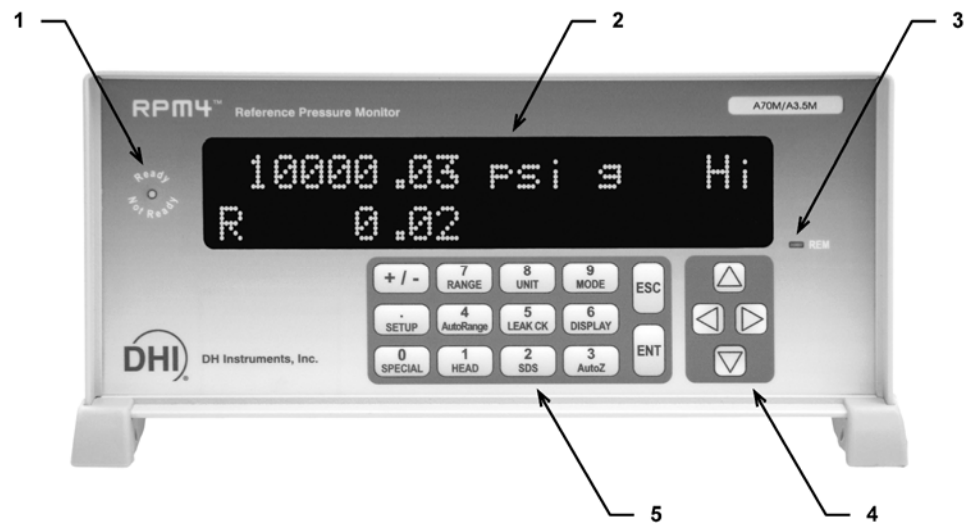

1. Ready/Not Ready Indicator
2. Display
3. Remote Activity Indicator
4. Cursor Control Keys
5. Multi-Function Keypad

Figure 1. Front Panel

2.3.2.2 REAR PANEL

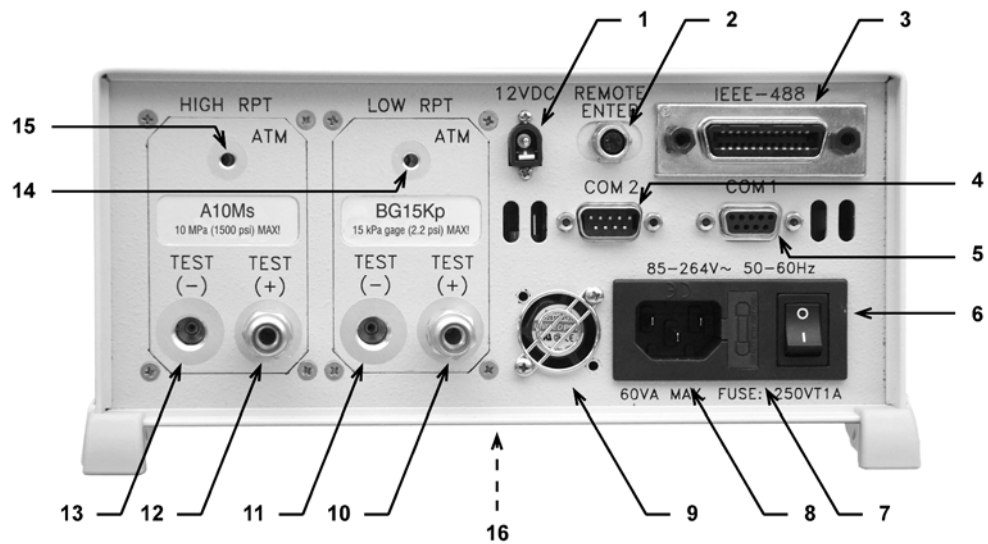

- | | |
|---|---|
| 1. 12VDC Power Supply Connection | 10. TEST(+) Pressure Port, Lo Q-RPT (if Lo Q-RPT present) |
| 2. Remote [ENT] Connector | 11. TEST(-) Pressure Port, Lo Q-RPT (if Lo-QRPT present, <A100M only) |
| 3. IEEE-488 Connector | 12. TEST(+) Pressure Port, Hi Q-RPT |
| 4. COM2 Connector | 13. TEST(-) Pressure Port, Hi Q-RPT (<A100M only) |
| 5. COM1 Connector | 14. VENT (<A10M>) or ATM (≥A10M) Pressure Port, Lo Q-RPT |
| 6. Power Switch | 15. VENT or ATM Pressure Port, Hi Q-RPT |
| 7. Fuse | 16. Product Label (bottom of case) |
| 8. Electrical Power Connector (IEC-320-C13) | |
| 9. Fan | |

Figure 2. Rear Panel

2.3.3 POWER CONNECTION

2.3.3.1 85 TO 264 VAC, 50/60 HZ VAC POWER

- ❶ Check that the RPM4 power switch is OFF.
- ❷ Connect the supplied power cable to the rear panel power module.
- ❸ Connect the other end of the power cable to an electrical supply of 85 to 264 VAC, 50/60 Hz.

2.3.3.2 BATTERY PACK

- ❶ Charge the battery pack fully (see Section 3.2.6).
- ❷ Connect the RPM4 12VDC power connection on the rear panel of the RPM4 to the 12 VDC power connection on the battery/charge pack using the cable supplied with the pack.



See Section 3.2.6 for additional information on battery/charger pack operation and maintenance.

2.3.4 REMOTE [ENT] CONNECTION (FOOTSWITCH OR OTHER SWITCH)

Connect the optional remote ENTER footswitch, if available or a user supplied switch fitted to the optional cable (see Section 7.1). Connect the cable to the RPM4 rear panel connection labeled **REMOTE ENTER**. Activating the switch is equivalent to pressing the **[ENT]** key on the front panel (see Section 3.1.3).

2.3.5 CONNECTING TO MEASURE PRESSURE (TEST(+) AND TEST(-) PORTS)

Using a pressure connecting hose or tube of appropriate pressure rating, connect the device or system to be tested to the RPM4 **TEST(+)** port.

The RPM4 **TEST(+)** connection is **1/8 in. NPT female** (Q-RPTs of A70M or lower) or **DH500 F** (Q-RPTs higher than A70M).



DH500 is a gland and collar type fittings for 6.35 mm (1/4 in.) coned and left hand threaded tubes. DH500 is equivalent to AE F250C, HIP HF4, etc.



The TEST(+) and TEST(-) ports on Q-RPT modules of A70M and lower are threaded into the aluminum Q-RPT manifold. Take care in making and breaking fittings not to cross thread or otherwise damage the threads. It is recommended that an adaptor be installed in the in Q-RPT manifold and make break operations be made on the adaptor rather than the manifold.



SDS Self Defense System: Q-RPT modules designated A7M or lower include the SDS Self Defense System. SDS, operated properly, allows a the Q-RPT TEST(+) port to be left connected to a pressure up to 10 MPa (1 500 psi) without damage to the Q-RPT. Do NOT attempt to use SDS in this manner without first becoming thoroughly familiar with its operation and limitations (see Sections 3.2.7, 3.3.8, 3.5.4).

Q-RPT MODULE TEST(+) AND TEST(-) PORTS

Q-RPT modules of A70M and lower have both **TEST(+)** and **TEST(-)** ports. Q-RPT modules greater than A70M have a **TEST(+)** port only. See Section 5.6, Figure 8 for RPM4 Q-RPT module **TEST** port configurations.

The **TEST(+)** port is connected to Axxx (absolute) Q-RPTs' sole measurement port and to the **high** side of Gxxx or BGxxx (gauge or bi-directional gauge) Q-RPTs.

The **TEST(-)** port of Axxx and BGxxx Q-RPTs is connected to RPM4's internal barometer. The **TEST(-)** is connected to the **low** side of Gxxx (gauge) or Gxxx (bi-directional gauge) Q-RPTs.

- **When operating in absolute mode:** The **TEST(-)** port, if present, is left open to atmosphere.
- **When operating in gauge or negative gauge mode with a range greater than 50 kPa (7.5 psi):** The **TEST(-)** port, if present, is normally left open to atmosphere. A possible exception is when the device or system under test is in an ambient pressure that may differ significantly from the ambient pressure around the RPM4. For example, if the RPM4 is measuring the pressure applied to DUTs in an environmental chamber, the pressure in the environmental chamber may be different from ambient pressure around the RPM4. In this

case, connecting a tube from the **TEST(-)** port to the inside of the chamber may improve measurement results. If the Q-RPT in use is an Axxx Q-RPT, this tube must be left open to the environment so that the pressure inside cannot deviate too far from ambient. When using an Axxx Q-RPT, if this tube is connected to the low or reference side of DUTs, be sure to open it to the local environment as well.

- **When operating in gauge or negative gauge mode with a range less than 50 kPa (7.5 psi):** As a general rule, it is preferable to connect the RPM4 **TEST(-)** port(s) directly to the low or reference side of the device under test to assure that these are at the same pressure. When using an Axxx Q-RPT, this connection must also be open to atmosphere. When using a Gxxx or BGxxx Q-RPT, it is preferable that this connection not be open to atmosphere.



Do not connect a pressure supply to the TEST(-) port. The pressure applied to this port should be maintained at atmospheric pressure (between 70 and 110 kPa (10 and 16 psia)). Exceeding these limits may damage a Gxxx or BGxxx Q-RPT and/or the RPM4's on-board barometer.



Using the RPM4 with gas operated Q-RPTs connected to a system with liquid contaminants without taking proper precautions to purge the system and test line may cause contamination of the RPM4 that will require non-warranty service.

2.3.6 THE VENT OR ATM PORT

RPM4 Q-RPT modules of A7M and lower have a **VENT** port. The **VENT** port is connected to the **TEST(-)** port when SDS is CLOSED (see Section 5.6, Figure 8). For Axxx and BGxxx Q-RPTs, the RPM4 on-board barometer, is connected to the **VENT** port when SDS is CLOSED. The **VENT** port should always be left completely unobstructed and open to atmosphere.

RPM4 Q-RPT modules of A10M and higher have an **ATM** port. The **ATM** port is connected to the RPM4 on-board barometer. The **ATM** port should always be left completely unobstructed and open to atmosphere.



NEVER plug, obstruct or connect a supply pressure to the RPM4 VENT or ATM port. This may adversely affect GAUGE mode operation and AutoZeroing functions.

2.3.7 CHECK/SET SECURITY LEVEL

RPM4 has a security system based on user levels. By default, the security system is set to "low", which includes access restriction to internal calibration coefficients, and there is no password required to change the security level. See Section 3.5.5.5 for information on the security level system. As part of the RPM4 startup, determine the security level that is appropriate for the RPM4 and set a password if desired.



RPM4 is delivered with the security level set to "low" to avoid inadvertent altering of critical internal settings but with access to changing security levels unrestricted. It is recommended that the low security level be maintained at all times and password protection be implemented if control over setting of security levels is desired.

2.3.8 TURN OFF ABSOLUTE AND NEGATIVE GAUGE MODE (Axxx RPT)

If your RPM4 has one or two Axxx (absolute) Q-RPTs, it is able to operate in gauge, negative gauge and absolute measurement modes (see Section 3.3.3). If the RPM4 will be used in gauge mode only, the other measurement modes can be turned off so they are no longer accessible. Turning off modes that are not needed can avoid confusion and/or accidental use of the wrong measurement mode. See Section 5.2.5 for complete information on turning off absolute and negative gauge measurement modes.

Turn off absolute and negative gauge mode if desired.

2.3.9 SDS FULL TIME OFF

Gas operated Q-RPT modules of A7M or less, include the SDS Self Defense System (see Section 3.2.7) to shut off the Q-RPT from the **TEST(+)** port. If this function is not desired, SDS can be turned full time off so that in regular operation, SDS is not present. With SDS full time off, the SDS overpressure protection is still active.

See Section 3.5.4.2 for instructions on turning SDS full time off if desired.

2.3.10 PARALLEL MEASUREMENT MODE

If your RPM4 has two Q-RPTs of the same type (Axxx, Gxxx, BGxxx), it supports parallel measurement mode in which both RPTs are used simultaneously to measure a common pressure, statistically reducing uncertainty in the measurement. Parallel measurement creates a new Q-RPT, designated **<HL>**, which is the combination of the Hi and Lo Q-RPTs. See Section 3.2.4 for complete information on parallel measurement mode.

Turn on parallel measurement mode if desired.

2.4 POWER-UP AND VERIFICATION

2.4.1 SWITCH POWER ON

Actuate the power switch on the RPM4 rear panel (if a 12 VDC power supply is already connected to the **12 VDC** connection, RPM4 power is already on). Observe the front panel display as RPM4 initializes, error checks and goes to the MAIN RUN screen (see Section 3.1.1).

RPM4 default power-up condition is Hi Q-RPT active, SDS closed if present.

If the RPM4 fails to reach the MAIN RUN screen, service is required. Record the sequence of operations and displays observed.



If the RPM4 Q-RPT module is equipped with SDS, SDS is CLOSED at power up and the TEST(+) port is shut off. This causes <SDS CLOSED> to be flash periodically in the main run screen in place of the measured pressure value.

2.4.2 CHECK PRESSURE MEASUREMENT OPERATION

2.4.2.1 CHECKING ABSOLUTE MODE PRESSURE MEASUREMENT

If the RPM4 has an Axxx (absolute) Q-RPT, check that it operates properly in **absolute** mode.

Make sure that the **TEST(+)** port is vented to atmosphere.

Use the **[RANGE]** function key to select the Axxx (absolute) Q-RPT DF range (see Section 3.3.1).

Press the **[MODE]** function key and select **<absolute>** mode (see Section 3.3.3). Use **[UNIT]** to change the pressure unit if desired (see Section 3.3.2).

If SDS is CLOSED (**<SDS CLOSED>** flashes over the display of pressure on the top line of the display), OPEN SDS. Press **[SDS]**, **<2yes>** to OPEN SDS (see Section 3.3.8).



Do NOT OPEN SDS with a pressure higher than the maximum pressure of the Q-RPT applied to the TEST(+) port. Damage to the Q-RPT may result.

Observe the current value of atmospheric pressure. Check that the value agrees with the local value of atmospheric pressure within measurement tolerances (see Section 1.2.2.1). Repeat this process for both Axxx (absolute) Q-RPTs if there are two in the RPM4. . If a Q-RPT does not agree within tolerance, it may need to be AutoZeroed (see Section 3.3.9), calibrated (see Section 5.2) or repaired.

2.4.2.2 CHECKING GAUGE MODE PRESSURE MEASUREMENT

Make sure that the **TEST(+)** port is open to atmosphere.

Press the **[MODE]** function key and select **<gauge>** mode. Use **[UNIT]** to change the pressure unit if desired (see Section 3.3.2)..

If SDS is CLOSED (**<SDS CLOSED>** flashes over the display of pressure on the top line of the display), OPEN SDS. Press **[SDS]**, **<2yes>** to OPEN SDS.



Do NOT OPEN SDS with a pressure higher than the maximum pressure of the Q-RPT applied to the TEST(+) port. Damage to the Q-RPT may result.

The value indicated should be near zero. It is normal for the Q-RPT to indicate a value other than zero when vented when **gauge** mode is first entered or the range is changed. Press **[AutoZ]**. This runs AutoZ to zero the Q-RPT reading (see Section 3.3.9.1). Upon return to the main run screen, observe that the indication of measured pressure has zeroed.

If the display fails to zero properly, RPM4 may need repair.

2.5 SHORT TERM STORAGE

The following is recommended for short term storage of RPM4:

- ❶ Vent the RPM4 test port
- ❷ Switch power OFF.



3. OPERATION

3.1 USER INTERFACE

RPM4 is designed to offer a balance between simple, straight forward operation and the availability of a wide variety of advanced functions with a high level of operator discretion. The local operator interface is through a 2 x 20 character alphanumeric display, a function/data keypad, a cursor control pad and a *Ready/Not Ready* indicator.

Remote communications are by RS232 (COM1) and IEEE-488. See Section 4 for information on remote communication.

3.1.1 MAIN RUN SCREEN

The RPM4 MAIN RUN screen is its home display that is reached on power-up and from which other functions and menus are accessed. It is the very top level of all menu structures.

The MAIN RUN screen is where RPM4 is left in normal operation. It displays the current measured pressure as well as a variety of additional information if desired.

Figure 3 and its legend summarize the RPM4 MAIN RUN screen fields and their functions.



RPM4 has a screen saver function which causes the display to dim if no key is pressed for 10 minutes. Pressing a key restores full power to the display. The screen saver time can be changed or screen saving can be completely suppressed (see Section 3.5.5.1).

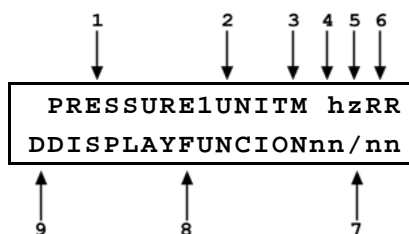

DISPLAY FIELD	NAME	PURPOSE	CONTENTS	SECTION
1. PRESSURE1	Measured pressure	Displays pressure measured by the active Q-RPT	Numerical pressure value and sign. Intermittently flashes <SDS CLOSED> when the Q-RPT is shut off from the TEST(+) port by SDS.	1.2.2.1 3.2.7
2. UNIT	Unit of measure	Identifies unit of measure in which pressure values are displayed	Pressure unit abbreviation	3.3.2
3. M	Measurement mode	Identifies measurement mode of displayed pressure	<a> absolute <g> gauge or negative gauge <d> differential	3.3.3
4. h	Head pressure indicator	Indicates whether a fluid head correction is applied to PRESSURE1	<h> the fluid head is not zero <blank> fluid head is zero	3.3.7
5. z	AutoZero indicator	Indicates whether the AutoZero function is ON or OFF for the active Q-RPT and measurement mode	<z> AutoZ is ON <blank> AutoZ is OFF	3.5.1
6. RR	Active Q-RPT position indicator	Indicates the position of the active Q-RPT in the RPM4	<Hi> Hi Q-RPT <Lo> Lo Q-RPT <HL> Hi and Lo Q-RPTs together in parallel measurement mode <Hd> Hi and Lo Q-RPTs together in differential measurement mode	3.2.3
7. nn/nn	Sequence progress indicator	Indicates progress of ATest sequence, during test execution	<NN/NN> Number of this point over total number of points in the sequence	3.3.10
8. DISPLAY FUNCTION	Information specific to the DISPLAY mode	Pressure indication depending on current RPM4 DISPLAY function. Leading character identifies the value	Numerical pressure value and sign. <PPC3 EXT DEV:> when the RPM4 is initialized as an external device to a PPC3 pressure controller.	3.3.6
9. D	Pressure information indicator	Pressure information indicator depending on current RPM4 DISPLAY function.	<σ> Display mode is AVERAGE and value is standard deviation <R> Display mode is RATE and value is pressure rate of change per second <H> Display mode is HI/LO and value is high, then low <D> Display mode is DEVIATION and value is difference from current target <<, ↑, ↓ > Display mode is RPT and value is measurement of inactive RPT <F> Display mode is FREEZE and value is last captured reading Blank, no character Current display mode is CLEAN	3.3.6

Figure 3. MAIN RUN Screen Display Fields

3.1.2 FUNCTION / DATA KEYPAD LAYOUT AND PROTOCOL

The RPM4 has a function/data keypad for local operator access to direct functions, function menus and for data entry.

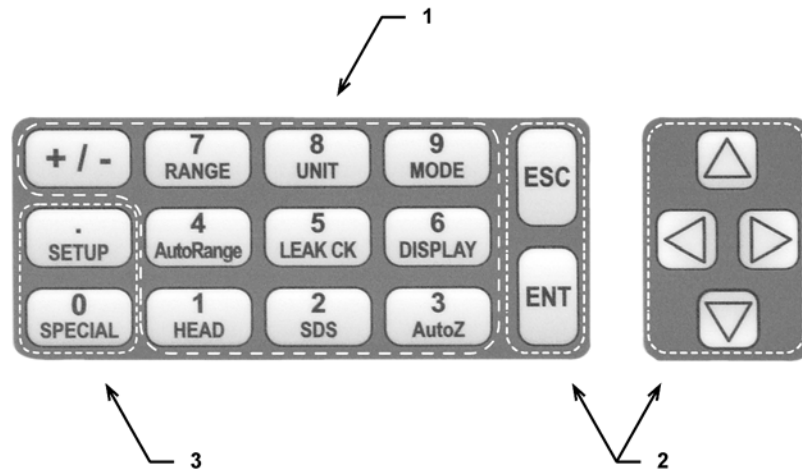

1. The **Function/Data keys** allow very commonly used functions to be accessed directly by a single keystroke when pressed from the MAIN RUN screen (see Section 3.1.1). The name of the function is on the bottom half of the key. These keys enter numerical values when editing.
2. The **Editing and Execution keys** are for starting and suspending command execution, cursor control in menus and editing entries.
3. The **Menu/Data keys** provide access to function menus when pressed from the MAIN RUN screen. The menu name is on the bottom half of the key. The SETUP menu is for more frequently used functions (see Section 3.4). The SPECIAL menu is for functions that are not generally used as a part of day to day operation (see Section 3.5). These keys enter numerical values when editing.

Figure 4. Keypad Layout

Pressing the **[ENT]** key generally causes execution or forward movement in the menu tree.

Pressing the **[ESC]** key moves back in the menu tree and/or causes execution to cease or suspend. Pressing **[ESC]** repeatedly eventually returns to the MAIN RUN screen and, from there, allows momentary viewing of the RPM4 introduction screen.

Pressing the **[+/-]** key changes a numerical sign when editing. It also toggles through multiple screens when available and, from some run screens, is a shortcut to a momentary display of active RANGE.

Pressing the **[▲]**, **[▼]**, **[◀]** and **[▶]** keys allows up, down, reverse and forward cursor movement when editing data **entry** or moving in menus.



Some screens go beyond the two lines provided by the display. This is indicated by a flashing arrow in the second line of the display. Press the cursor control keys to move the cursor to access the lines that are not visible or directly enter the number of the hidden menu choice if you know it.

3.1.3 REMOTE [ENT] (ENTER) FOOTSWITCH

The optional remote ENTER function is a switch that duplicates the function of the front panel [ENT] key. The remote ENTER function is serviced by a connector on the RPM4 rear panel. An optional footswitch is available to activate remote entry hands free or a different switch may be used. See Section 7.1 for information on remote ENTER switch wiring.

The remote ENTER feature can be particularly convenient when running AutoTests (see Section 3.3.10) in which using a footswitch to [ENT] allows hands free operation. It can also be used, with the FREEZE display function (see Section 3.3.6.6) to capture the activation point of a pressure switch.

3.1.4 SOUNDS

RPM4 is equipped with a variable frequency tone device to provide audible feedback and alarms. The beeper is used for the following indications.

Valid key press	Brief beep. Choice between three frequencies or NO sound is available (see Section 3.5.5.2).
Invalid key press	Descending two tone “blurp”
Leak check completed	Three two second beeps (see Section 3.3.5).
Upper or lower limit exceeded	Intermittent one second beeps (see Section 3.4.4).
Pmax! (overpressure limit) exceeded	Eight second high frequency beep (see Section 3.4.4.1).
Parallel measurement mode possible disconnection of the Hi and Lo Q-RPTs	Rapid beeps for 8 seconds (3.2.4).
AutoTest in/out of tolerance reading	Ascending triad/descending triad (see Section 3.3.10).

3.2 GENERAL OPERATING PRINCIPLES

3.2.1 PRESSURE READY/NOT READY

There is a *Ready/Not Ready* indication LED on the RPM4 front panel. This indication is intended to provide the user with a clear and objective indication of when a stable pressure has been achieved. Ready is indicated when the current stability (rate of change) of pressure is less than the stability limit. The user can set the stability limit (see Section 3.4.3). The ready indication is often used when comparing the RPM4 and a test device to indicate when a valid reading can be made.



In RPM4s with two Q-RPTs, the Ready/Not Ready indication always applies to the active Q-RPT, whose pressure measurement is displayed on the top line of the RPM4 display. When the inactive Q-RPT measurement is displayed on the second line using the RPT display mode, the Ready/Not Ready indication for the inactive RPT is indicated by the leading character on the line. <<> indicates Ready. <↑> or <↓> indicate Not Ready, pressure increasing or pressure decreasing.

The *Ready/Not Ready* LED indications are:

- <Green > *Pressure Ready* The pressure stability is within the stability limit.
 <Red> *Pressure Not Ready* The pressure stability is NOT within the stability limit.



In differential measurement mode (see Section 3.3.3.1), the LED *Ready/Not Ready* indication applies to the differential pressures.

In parallel measurement mode (see Section 3.2.4), the LED *Ready/Not Ready* indication applies to the average pressure read by the <HL> Q-RPT.



When RPM4 is being used as an external measurement reference of a PPC3 pressure controller, the *Ready/Not Ready* indication is still based on the RPM4 stability and stability limit only. The RPM4's *Ready/Not Ready* LED does not indicate whether the PPC3 pressure control is *Ready*.

3.2.2 GAUGE AND NEGATIVE GAUGE MODES WITH AN AXXX (ABSOLUTE) Q-RPT, DYNAMIC COMPENSATION FOR ATMOSPHERIC PRESSURE

Q-RPTs with the designation Axxx are intrinsically absolute but they are also used for gauge and negative gauge measurement modes (see Section 3.3.3, ○ PRINCIPLE). Gauge measurement modes are achieved by subtracting the value of atmospheric pressure, $P_{\text{offset,G}}$, from the Q-RPT's absolute reading using AutoZ (see Section 3.2.2). The AutoZ routine that measures $P_{\text{offset,G}}$, is run by pressing **[AutoZ]** whenever RPM4 is in the vented condition. This assures the continuous updating of the $P_{\text{offset,G}}$ value corresponding to atmospheric pressure. Gauge pressure is the measured absolute pressure, P_u , minus the atmospheric offset.

$$P_{\text{gauge}} = P_u - P_{\text{offset,G}}$$

However, atmospheric pressure may change between opportunities to run AutoZ and update the value of $P_{\text{offset,G}}$, for example when running an extended test without venting. RPM4 uses **dynamic compensation for atmospheric pressure** to correct for changes in atmospheric pressure between opportunities to run AutoZ and update $P_{\text{offset,G}}$. When AutoZ runs, and $P_{\text{offset,G}}$ is determined, the reading of RPM4's on board barometer, $P_{\text{atm,0}}$, is also recorded. Later, when no longer vented, the change in atmospheric pressure, ΔP_{atm} , since $P_{\text{offset,G}}$ was updated, is the difference between the current barometer reading, P_{atm} , and the barometer reading at the time of AutoZ execution, $P_{\text{atm,0}}$:

$$\Delta P_{\text{atm}} = P_{\text{atm}} - P_{\text{atm,0}}$$

Dynamic compensation for atmospheric pressure uses ΔP_{atm} to correct the value of $P_{\text{offset,G}}$, thus always compensating real time for changes in atmospheric pressure:

$$P_{\text{gauge}} = P_u - P_{\text{offset,G}} - \Delta P_{\text{atm}}$$

Gauge pressure measurement on an Axxx (absolute) Q-RPT allows instantaneous switching between gauge and absolute measurements modes. The additional uncertainty in gauge pressure mode due to the dynamic compensation for atmospheric pressure technique is a function of the resolution and short term stability of the on-board barometer, not its absolute measurement uncertainty. This additional uncertainty is ± 1 Pa (0.00015 psi).

3.2.3 MULTIPLE RANGES (Q-RPTS, AUTORANGE AND INFINITE RANGING)

An RPM4 may have one or two Q-RPTs. Position indication of the currently active Q-RPT is continuously displayed in the upper right hand corner of the MAIN RUN screen and most other screens. See Table 3 for position designation protocol for the Q-RPTs in an RPM4.

See Table 1 for a complete listing of RPM4/RPM4 Q-RPT choices and their default ranges.

Table 3. Position Designators of Q-RPTs in an RPM4 System

Q-RPT POSITION	DISPLAY SYMBOL*
Q-RPT with highest maximum pressure, installed in HIGH RPT position	Hi
Q-RPT with lower maximum pressure in dual Q-RPT RPM4, installed in LOW RPT position.	Lo
Two Q-RPTs being used simultaneously in parallel measurement mode	HL
Hi Q-RPT when used in differential measurement mode	Hd

* The display symbol is included in the upper, right hand corner of most RPM4 menu displays as a convenient indicator of the active Q-RPT.

An RPM4 may have multiple ranges. Each RPM4 Q-RPT has a default range which is its maximum span. Additional ranges, lower than the Q-RPT's maximum span, may also be created using AutoRange (see Section 3.3.4). Ranges created using are AutoRange temporary but may be saved with all their settings for reactivation (see Section 3.4.1).

AN RPM4 range is identified by a range screen showing the Q-RPT used by the range, its current unit of measure and its full scale pressure in gauge and absolute (if available) measurement modes. The range screen is:

1. Q-RPT designator.
2. Type of range. DF for the Q-RPT's default range; AR for a range created by AutoRange.
3. Q-RPT position designator.
4. Current pressure unit of measure.
5. Full scale pressure in current unit of measure in gauge (<g>) and/or absolute (<a>) measurement mode depending on type of Q-RPT and range.

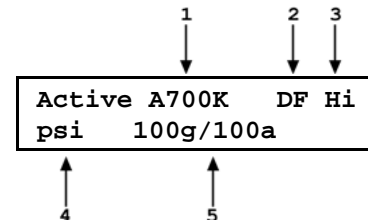

The ranges available on an RPM4 system are accessed using **[RANGE]** (see Section 3.3.1) and/or created using **[AutoRange]** (see Section 3.3.4).

Most settings made in an RPM4 range, such as unit of measure, measurement mode, display resolution, and stability setting are specific to the range. Settings selected while one range is active apply to that range and not to other ranges. The range specific settings are stored with the range and recalled whenever the range is made active. This makes setting up ranges a convenient way to store and recall frequently used operating configurations. See Table 4 for a listing of RPM4 adjustments and settings and whether they are range, Q-RPT or system specific.

Table 4. Settings and What They Are Specific To
(Range, Measurement Mode, Q-RPT, System)

SETTING	PURPOSE	SPECIFIC TO	SECTION
[Unit]	Set pressure unit of measure	Range	3.3.2
[Mode]	Set pressure measurement mode (absolute, gauge, negative gauge)	Range	3.3.3
[Display]	Set bottom line display function	System	3.3.6
[Head]	Set fluid head correction height, fluid, unit of measure	System	3.3.7
[SDS]	Open and close SDS	Q-RPT	3.3.8
[AutoZ]	Run AutoZ	Q-RPT and measurement mode	3.3.9
Resolution	Set pressure display resolution	Range	3.4.2
Stability	Set <i>Ready/Not Ready</i> stability test.	Range	3.4.3
Upper Limit	Set upper and lower pressure limit alarm	Range and measurement mode	3.4.4
AutoZ	AutoZ, ON/OFF, set and view values	Q-RPT and measurement mode	3.5.1
Screen Saver, Sound, Time, ID, Level	Set system user preferences	System	3.5.5
Lo vnt	Set status of TEST(-) vent valve, if present	Q-RPT	3.5.7.4
Cal	Various Q-RPT and barometer calibration functions, including turning off absolute and negative gauge modes	Q-RPT or barometer	3.5.8

3.2.4 PARALLEL MEASUREMENT MODE

RPM4s equipped with two Q-RPT modules of the same type (Axxx, Gxxx, BGxxx) can be set to operate in parallel measurement mode.

Parallel measurement mode is intended to improve measurement reliability and reduce measurement uncertainty by using the measurements of two Q-RPTs together. In parallel measurement mode, the measured pressure is the average of the readings of the two Q-RPTs.

Parallel measurement mode is considered a third Q-RPT designated **<HL>** (combination of Hi and Lo). Once it has been set up, the HL Q-RPT can be selected using the **[RANGE]** key and operated with all the features of a Hi or Lo Q-RPT. When setting up parallel measurement, the Hi and Lo Q-RPTs can be suppressed so that only the HL Q-RPT is active. This feature is used when the RPM4 will always be used in HL mode.

Parallel measurement mode is set up using **[SPECIAL]**, **<7internal>**, **<3RPT2x>** (see Section 3.5.7.3).

3.2.5 USING RPM4 WITH A PPC3 CONTROLLER/CALIBRATOR

RPM4 can be integrated as a reference pressure measuring device in a PPC3 Pressure Controller/Calibrator System. See the PPC3 Operation and Maintenance Manual for information on setting up RPM4 to operate as the PPC3's external device.

Before an RPM4 is used with a PPC3, the following settings should be made:

SDS Close SDS on all Q-RPT modules on which SDS is available (see Section 3.2.7).

Head If the RPM4 **TEST** port is at a different level than the PPC3's **TEST** port AND the RPM4 will be used in absolute measurement mode, set the RPM4 head height to the PPC3's **TEST** port level so that RPM4 is corrected to indicate the pressure at the level of the PPC3 **TEST** port (see Section 3.3.7).

AutoZ Make sure AutoZ is ON for all RPTs and measurement modes (see Section 3.5.1).

Certain RPM4 settings may be changed when an RPM4 is operated with a PPC3. Settings that may be changed when an RPM4 is used as a PPC3 external device include:

SDS Closed or open status may be changed and SDS full time off will be overwritten to full time on (see Sections 3.3.8, 3.5.4)

AutoRange range May be rewritten (see Section 3.3.4).

Display When an RPM4 is initialized by PPC3 as an external device, the second line of the RPM4 display is **<PPC3 EXT DEV: IDLE>**. When the RPM4 is the active Q-RPT being used by the PPC3, the second line of the RPM4 display is **<PPC3 EXT DEV: ACTIVE>**

Range Active range may be changed (see Section 3.3.1).

Unit of measure Active unit may be changed (see Section 3.3.2).

Measurement mode Active mode may be changed (see Section 3.3.3).

Lo Vent Setting may be changed (see Section 3.5.7.4).

Communications For a PPC3 to be able to identify and communicate with an RPM4, the RPM4's COM1 port must be set to:

Baud rate 9200 to 19200

Parity Even

Data bits 7

Stop bit 1

When RPM4 is activated by a PPC3, the PPC3 sets the RPM4 COM1 port baud rate to 19200. The COM1 port keeps this setting until power is cycled. Cycling power restores the previous baud rate setting. The same is true for the COM2 of the first RPM4 in a chain of two RPM4s used with a PPC3.



When RPM4 is initialized as an external device to a PPC3 pressure controller, the RPM4 front panel keypad is locked out and the second line of the display becomes:

<PPC3 EXT DEV: IDLE> (if RPM4 is initialized by PPC3 but not currently in use)

<PPC3 EXT DEV: ACTIVE> (if RPM4 is initialized by PPC3 and is currently in use)

After using an RPM4 as an external device for a PPC3, cycle power to return to the previous RPM4 settings, restore front keypad capability and return to the normal main run screen.

3.2.6 USE OF THE 12VDC BATTERY/CHARGER PACK

An optional 12VDC battery/charger pack is available to supply power to RPM4s **12VDC** power connection (see 1.2.3).

The battery/charger pack combines the battery and the battery charger.

To Charge the Battery

The battery may be charged while the battery/charge pack is connected to the RPM4.

To charge the battery, connect the battery/charger pack to a 100 to 240 V, 50/60 Hz power supply using the supplied power cable and turn on the charger power switch. The green CHARGE indicator light goes on to indicate that battery charging is in progress. Allow 14 to 16 hours for the battery to charge fully. When the battery is fully charged, the CHARGE indicator light flashes.

When the battery charger power switch is in the ON, the battery is connected to the charger, not the 12VDC output. When the battery charger switch is in the OFF position, the CHARGE indicator light goes off, and 12VDC is supplied on the 12VDC connection.

To Use the Battery/Charger Pack to Supply RPM4

After charging the battery, connect the 12VDC connection of the battery/charger pack to the 12VDC connection on the RPM4 rear panel.

Turn the battery/charger pack power switch to OFF (when AC power is connected to the battery/charger pack, the power switch must be OFF for 12VDC power to be output).

When RPM4 is connected to **both** a 12 VDC source and an AC source, if the RPM4 power switch is OFF, the 12VDC source supplies the RPM4; if the RPM4 power switch is ON, the 12 VDC source is disconnected and the AC source supplies the RPM4.

To Check the Battery Charge Level

To check the current charge level of the battery, press the toggle switch on the battery/charger pack front panel. Observe the BATTERY CHECK indicator lights. All three lights are lit when battery is fully charged. If no light or one light is on, the battery should be recharged.

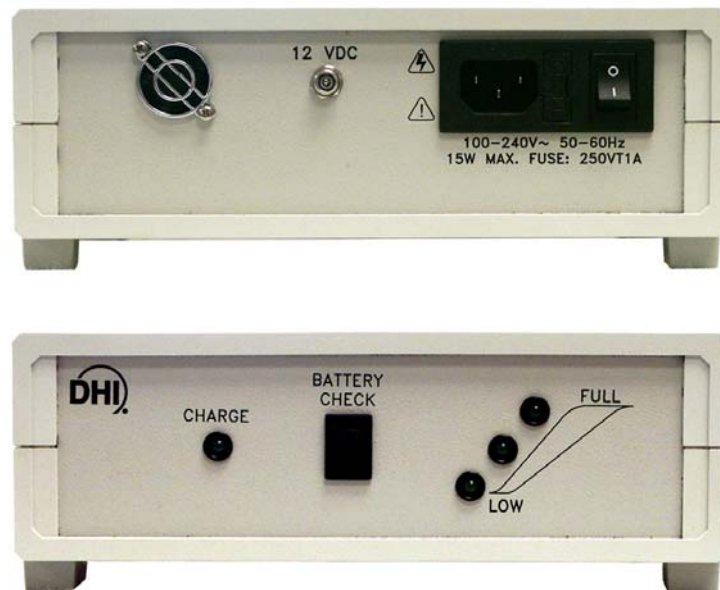

Figure 5. Battery Pack/Charger

3.2.7 SDS SELF DEFENSE SYSTEM

Q-RPT modules designated 7M or lower that are NOT liquid filled are equipped with the SDS self defense system. The SDS system includes hardware and embedded software to isolate Q-RPTs from overpressure. When SDS is CLOSED for a Q-RPT module, the Q-RPT is isolated from the modules **TEST(+)** port and opened to the modules **VENT** port (See Section 5.6, Figure 8).

SDS can be OPENED and CLOSED from the front panel using [**SDS**]. SDS can also be controlled using functions under [**SPECIAL**], <**4SDS**>. The SDS “temp open/close” function allows SDS on both Q-RPTs, whether active or inactive, to be opened and closed directly (see Section 3.5.4.1). The SDS “full time on/off” function allows SDS to be opened permanently so the RPM4 can be operated as if SDS were not installed (see Section 3.5.4.2).

SDS is normally used to isolate an RPM4 Q-RPT from a test system which may sometimes be subjected to pressures higher than the Q-RPTs maximum pressure. When configuring a multi-range system, this can eliminate the need for external valving or connecting and disconnecting RPM4s. For example, two Q-RPTs of different ranges might be connected to a single calibration system. When the Hi Q-RPT is in use, SDS is closed on the Lo Q-RPT to protect it from overpressure. When used in this manner, SDS should be CLOSED prior to applying pressure. Automatic SDS closing in response to overpressure should only be used in an emergency overpressure situation.

SDS also attempts to protect Q-RPTs from accidental overpressure. Whenever RPM4 is powered ON it continuously monitors the pressure read by its Q-RPT(s). If the pressure reaches the maximum pressure limit for a Q-RPT, SDS CLOSES to isolate the Q-RPT from the TEST port and vent it to atmosphere (see Section 3.4.4.1). This is not a fail safe overpressure system. It does not protect against very rapid overpressure or pressure exceeding 10 MPa (1 500 psi).



When an RPM4 is used as an external device to a PPC3 pressure controller, PPC3 controls the RPM4's SDS to isolate the RPM4 Q-RPTs from the test pressure when they are not in use. IF the RPM4 SDS is “full time off” PPC3 changes it to “ON”.



The maximum pressure that should be applied to an RPM4 TEST(+) port when SDS is CLOSED is 10 MPa (1 500 psi).



Though the SDS self defense system includes features to automatically protect Q-RPTs against accidental overpressure, SDS should NOT be considered a fail-safe overpressure protection system. SDS cannot guarantee that overpressure damage will NOT occur. Conventional measures for overpressure protection should also always be used. Damage to Q-RPTs due to overpressure is NOT covered by the RPM4 product warranty even when SDS is present and ON.

3.2.8 DIRECT FUNCTION KEYS SUMMARY



Table 5 provides a brief summary of direct function key operation. It may be useful to keep a copy of this summary near the RPM4, especially when first becoming acquainted with its operation.

Local operation of RPM4 is through the front panel keypad. To minimize multi-layered menu structures, the keypad numerical keys also provide direct access to the most commonly used functions. The function accessed is labeled on the bottom half of the key. Direct function keys are active whenever RPM4 is in its MAIN RUN screen. Table 5 summarizes the operation of the direct function keys.

Table 5. Summary of RPM4 Function Key Operation

DIRECT FUNCTION KEYS ARE ACTIVE FROM THE MAIN RUN SCREEN			
See corresponding manual sections for full detail.			
1 HEAD	Adjust height of fluid head correction. Set to zero to defeat correction.	7 RANGE	View active range and toggle through available ranges. [ENT] on a range activates it.
2 SDS	.SDS controls the connection of the Q-RPT to the TEST(+) port. Close any open SDS. Open SDS of active Q-RPT if closed.	8 UNIT	Select pressure unit of measure for the active range. Choice of units available in this menu can be customized.
3 AutoZ	Run the AutoZ function to AutoZero the active Q-RPT and measurement mode.	9 MODE	Select the pressure measurement mode for the active range (absolute, gauge, negative gauge, differential).
4 AutoRange	Set up and optimize RPM4 features for a specific operating range and measurement mode.	0 SPECIAL	Menu of less commonly used internal functions and settings.
5 LEAK CK	Run automated leak checking routine.	. SETUP	Menu of commonly used setup features including save/delete AutoRange ranges, set display resolution, set stability limit, set upper/lower, view AutoTest data
6 DISPLAY	Select the display function for the bottom line of the RPM4 display.	ENT	Start or set functions such as Leak Check, AutoTest and Freeze. ENTER values when editing.

3.3 DIRECT FUNCTION KEYS

3.3.1 [RANGE]

○ PURPOSE

To view and/or change the active pressure measurement range and associated settings.

○ PRINCIPLE

An RPM4 range is defined as a pressure span and associated settings (see Section 3.2.3).

An RPM4 may have multiple ranges. Each Q-RPT in the RPM4 system has a default range which is its maximum span. Additional ranges, lower than the Q-RPT's maximum span, may also be created using AutoRange (see Section 3.3.4). Ranges created using AutoRange may be saved, with their settings, for reactivation (see Section 3.4.1).

The [RANGE] function key allows the available RPM4 pressure ranges to be viewed and selected.

○ OPERATION

Pressing the **[RANGE]** function key activates the range viewing and selecting function. When the **[RANGE]** function key is first pressed, the active range is displayed. For example:

1. Q-RPT designator.
2. Type of range. DF for the Q-RPT's default range; AR for a range created by AutoRange.
3. Q-RPT position designator.
4. Current pressure unit of measure.
5. Full scale pressure in current unit of measure in gauge and/or absolute measurement mode depending on type of Q-RPT and range.

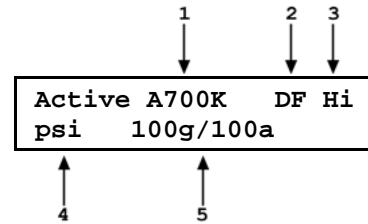

Pressing the **[+/-]** key or the **[RANGE]** key again while in the RANGE functions toggles through displays of the other available ranges, from lowest range to highest range.

To select a range to become the active range, press **[ENT]** while the range is displayed.

Pressing **[ESC]** while in the RANGE function returns to the MAIN RUN screen without making a range change.



Range full scale limits are given in the pressure unit that is currently active for that range.



Pressing **[+/-]** from the MAIN RUN screen provides a shortcut to a momentary view of the active range.



Many RPM4 settings and functions are range specific. See Table 4 for identification of range specific settings.



For best metrological performance, vent the RPM4 Q-RPT before changing ranges.

3.3.2 [UNIT]

○ PURPOSE

To select the unit of measure in which RPM4 displays pressure values.



For information on selecting the measurement mode (absolute, gauge, negative gauge, differential), see Section 3.3.3.

○ PRINCIPLE

RPM4 allows the unit of measure in which pressure values are displayed to be changed.

RPM4 supports 15 standard pressure units of measure as well as user defined units. To simplify operation, quick access to six units is made available under the **[UNIT]** key. The default units available depend on whether the RPM4 was originally configured as an SI or US version. The **[UNIT]** key contents can be customized by the user to any configuration of six units (see Section 3.5.6).



Internally, RPM4 always operates in Pascal (Pa), the SI unit of pressure. Values of pressure are represented in other units by the application of conversion factors to convert from Pa (see Section 7.2.1).

○ OPERATION

To change the active pressure unit of measure for a range, press **[UNIT]** from the MAIN RUN screen while the range is active. The display is:

1kPa	2Pa	3MPa
4hPa	5bar	6mbar

The cursor is on the number corresponding to the active pressure unit of measure for the active range.

To change the pressure unit of measure, select the desired unit. Making the selection returns to the MAIN RUN screen with the selected unit active.



The pressure unit of measure selected is range specific. When in a given range, all functions and settings are represented in the current measurement unit for that range. However, certain internal and/or metrological functions (e.g., Q-RPT calibration coefficients) are always represented in Pa regardless of the current range unit. When the current unit is an altitude unit, the range and upper limit indications are in kPa if the unit is meters (m) and psi if the unit is feet (ft).



See Section 7.2.1 for tables of the conversion factors used by RPM4.



If the pressure unit selected is inWa (inches of water), the reference temperature for water density must be specified in a separate menu (choices are 4°C, 20°C 60°F). No reference temperature selection is necessary for the unit mmWa as the only reference temperature commonly used for mmWa is 4 °C.



The default pressure units of measure available under the UNIT function depend on whether the RPM4 has been set up as an SI or US version (indicated by SI or US at bottom right of introduction screen). The choice of six units available under the UNIT function can be customized from a wider selection by the user (see Section 3.5.6). The units available under the UNIT function can be reset to default by reset (see Section 3.5.9.2).

3.3.3 [MODE]

○ PURPOSE

To set the measurement mode (absolute, gauge, negative gauge or differential) for the active range.



For information on selecting the unit of measure, see Section 3.3.2.

○ PRINCIPLE

RPM4 supports simple, one-step switching between up to four different measurement modes:

Absolute Measures pressure relative to vacuum (zero is hard vacuum). Range is from zero absolute to full scale.

- Gauge** Measures pressure relative to atmosphere (zero is ambient pressure). Range is from zero gauge to full scale, full scale must be greater than zero.
- Negative Gauge** Measures pressure relative to atmosphere (zero is ambient pressure). Range is positive and negative from zero, negative to minus one atmosphere and positive to full scale. With a BGxxx RPT, negative range is the negative equivalent of the positive range.
- Differential** Available only for the Hi Q-RPT in RPM4s equipped with two Q-RPT modules of the same type (Axxx, Gxxx, BGxxx). Measures the difference between the Hi and the Lo Q-RPT (Differential = Hi – Lo). Differential measurement mode is selected “on top of” the Hi Q-RPT’s base measurement mode (gauge, absolute or differential). Differential range is positive to maximum pressure of the Hi Q-RPT and negative to the minimum pressure of the Lo Q-RPT base measurement mode (see Section 3.3.3.1 for specific information on operation in differential measurement mode).

Which measurement modes are available depends on the type of Q-RPT type(s) available. There are three types of Q-RPTs:

- Axxx** Q-RPTs with designators starting with “A” measure pressure relative to a sealed vacuum reference and are intrinsically absolute. Axxx Q-RPTs support measurement in absolute, gauge and negative gauge modes. Gauge and negative gauge modes are accomplished by offsetting of atmospheric pressure with dynamic compensation for atmospheric pressure changes between offsets using an on-board barometer (see Section 3.2.2). Access to absolute and negative gauge operation can be turned OFF (see Section 5.2.5). In RPM4s with two Axxx Q-RPTs, differential measurement mode is supported on the Hi Q-RPT.
- Gxxx** Q-RPTs with designators starting with “G” measure positive pressure relative to the **TEST(-)** port that is connected to atmosphere. Gxxx Q-RPTs support measurement in gauge mode only. In RPM4s with two Gxxx Q-RPTs, differential measurement mode is supported on the Hi Q-RPT.
- BGxxx** Q-RPTs with designators starting with “BG” measure positive and negative pressure relative to the **TEST(-)** port that is connected to atmosphere. BGxxx Q-RPTs support measurement in gauge and negative gauge modes. In RPM4s with two BGxxx Q-RPTs, differential measurement mode is supported on the Hi Q-RPT.

When changing modes for a range, if the full scale of the range is 700 kPa (100 psi) or greater, the full scale is the same in both absolute and gauge modes. If the full scale is less than 700 kPa (100 psi), the gauge mode full scale is 100 kPa (14.5 psi) lower than the absolute mode full scale. If the absolute mode full scale is less than 100 kPa (14.5 psi), there is no gauge mode available. Gauge and negative gauge modes, when available, always have the same full scale.

Measurement mode selection is range specific.

○ OPERATION



See Section 3.3.3.1 for information on differential mode operation. Differential mode operation is only available for the Hi Q-RPT in RPM4s that are equipped with two Q-RPTs of the same type (Axxx, Gxxx, BGxxx).

To change the active measurement mode for a range, press **[MODE]** from the MAIN RUN screen while the range is active. The display depends upon the type of Q-RPT that is active.

<p>Measurement mode: 1abs 2gauge 3neg gage</p>
--

If an Axxx Q-RPT is active, all three measurement modes are supported: absolute, gauge and negative gauge. Only gauge is available if absolute and negative gauge modes have been turned OFF in calibration (see Section 5.2.5).

If a Gxxx Q-RPT is active, only gauge measurement mode is supported. When the **[MODE]** key is pressed, **<Gauge RPT, gauge mode only>** is displayed.

If the Hi Q-RPT is active in its default range (**<DF>**), and the RPM4 has two Q-RPTs of the same type (Axxx, Gxxx, BGxxx), differential measurement mode is available in addition to the other modes (see Section 3.3.3.1).



Certain RPM4 settings, including AutoZ ON/OFF (see Section 3.5.1) are range AND measurement mode specific. See Table 4 for a listing of settings and what they are specific to.



Absolute and negative gauge modes on an Axxx Q-RPT can be turned OFF in the calibration function (see Section 5.2.5). When absolute and negative gauge mode are turned OFF for an Axxx Q-RPT, only gauge mode can be activated. **<Gauge mode only, other modes OFF>** is displayed when **[MODE]** is pressed.

3.3.3.1 DIFFERENTIAL MEASUREMENT MODE OPERATION



Differential mode operation is only available on the Hi Q-RPT, default (**<DF>**) range, in RPM4s that are equipped with two Q-RPTs (Hi and Lo) of the same type (Axxx, Gxxx, BGxxx).

To activate differential measurement mode, press **[MODE]** from the MAIN RUN screen while the Hi Q-RPT is active and in its default (**<DF>**) range. The actual display depends upon the measurement modes available on the Hi Q-RPT.

The cursor is on the base measurement mode. The line pressure measurement mode is the base pressure measurement mode.

Meas mode: 1abs 2gage 3neg gage 4dif

To activate differential measurement mode, press the keypad number key for the **<dif>** selection or move the cursor to the **<dif>** selection and press **[ENT]**. Operation returns to the main run screen. When differential mode is active, the cursor is on both the base mode and differential mode.



When differential mode is active, the Q-RPT position indicator is in the upper right hand corner of the main run screen and other displays is **<Hd>** instead of **<Hi>** (see Section 3.2.3, Table 3).



When differential mode is activated, AutoZ should be run at the line pressure with zero differential pressure applied to eliminate the zero error on differential pressure due to the disagreement of the Hi and Lo Q-RPTs (see Section 3.3.9.3).

The following operating conditions are specific to differential mode:

Main run screen measured pressure display

The display of measured pressure in the main run screen is the difference between the Hi and the Lo Q-RPTs (Hi – Lo) with a differential mode AutoZ correction (see Section 3.3.9.3). The pressure measurement mode indicator is **<d>**. The Q-RPT position indicator is **<Hd>**.

Default DISPLAY function

The default display function is RPT with the Lo Q-RPT displayed on the bottom display line (see Section 3.3.6.4). This allows the line pressure (Lo Q-RPT indication) to be viewed simultaneously with the differential pressure. All other DISPLAY functions (average, rate, deviation, HiLo, freeze) apply to the differential pressure

SDS function

[SDS] key operation to OPEN SDS opens SDS of both the Hi and Lo Q-RPTs simultaneously. (see Section 3.3.8). Overpressure is driven by the pressure range of the Lo Q-RPT (see Section 3.4.4.1).

AutoZ function

AutoZ manages zeroing of differential mode and is intended to “tare” the two Q-RPTs at a common line pressure (see Section 3.3.9.3). Switch to a mode other than differential for AutoZ functions of an individual Q-RPT.

Leak Check function

The leak check function uses the differential mode measurement (see Section 3.3.5).

Head function

The head function applies to the differential pressure (see Section 3.3.7).

AutoRange function

Differential measurement mode is not available in AutoRange (see Section 3.3.4).

UL function

The UL limits apply to positive and negative differential pressure (see Section 3.4.4) and the default is the maximum value of the differential pressure. Both the Lo and Hi RPT base measurement mode ULs also remain active. The Hi RPT UL provides a upper limit for the maximum pressure on the Hi side of the differential pressure. Both the differential and base mode Hi RPT UL cause the display of differential pressure to flash when exceeded. The Lo RPT UL provides an upper limit for the line pressure.

AutoTest function

The AutoTest function (see Section 3.3.10) is not available in differential measurement mode.

3.3.4 [AUTORANGE]

○ PURPOSE

To automatically set up RPM4 to optimize its measurement characteristics and features for specific, user specified range of operation.

○ PRINCIPLE

RPM4 is designed to support the calibration and test of a very wide variety of test ranges in various measurement modes.

The AutoRange function simplifies the task of selecting the Q-RPT best suited to cover a specific test range and setting measurement parameters appropriately for the range. These are set automatically based on operator entry of desired measurement mode, pressure unit of measure and range full scale. The selections and settings made by AutoRange are summarized in Table 6.

A range set up using AutoRange and all its range specific settings, may be saved for recall using **[SETUP]**, **<1range>** (see Section 3.4.1). Saved ranges are available for later selection using **[RANGE]** (see Section 3.3.1). If a range created by AutoRange is not saved, it is overwritten by the next AutoRange or erased when another range is selected.



Press **[ENT]** from the main run screen in RATE mode to use the **[AutoTest]** function to AutoRange RPM4 based on DUT tolerance (see Section 3.3.10).

Table 6. Settings Made by AutoRange

SETTING/SELECTION	PURPOSE	SET TO	SECTION
Unit	Set pressure unit of measure	Operator specified during AutoRange	3.3.2
Mode	Set pressure measurement mode (absolute, gauge, negative gauge)	Operator specified during AutoRange	3.3.3
Full scale	Establish span maximum	Operator specified during AutoRange	None
AutoRange span	Basis of span based setting calculations	Absolute mode: Zero absolute to AutoRange full scale Gauge mode: Zero gauge to AutoRange full scale Negative gauge mode: Minus atmosphere to AutoRange full scale (negative equivalent of full scale on BG15K Q-RPT).	None
Q-RPT	Select most appropriate Q-RPT to cover range and mode.	Absolute and negative gauge mode: Axxx Q-PRT with lowest default full scale that is greater than the AutoRange full scale Gauge mode: Q-RPT with lowest span whose full scale is greater than AutoRange full scale, Gxxx over Axxx if spans are equal.	1.2.2.1
Upper limit Lower limit	Set maximum and minimum pressure alarm limits.	Upper limit: 105 % of operator entered full scale pressure Lower limit: None in absolute and gauge modes. Minus atmosphere in negative gauge mode, minus equivalent of upper limit in negative gauge mode on a BG15K Q-RPT. Minus 66 kPa (9.6 psi) with BA100K.	3.4.4
Resolution	Set display resolution	10 ppm of AutoRange span or 1 ppm of default Q-RPT span, whichever is larger.	3.4.2
Stability Limit	Set Ready/Not Ready stability criterion.	50 ppm of AutoRange span or 2 ppm of default Q-RPT span, whichever is larger.	3.4.3, 3.3.4
Q-RPT turn down (Premium class Q-RPTs only)	Turn down Q-RPT characterization to improve measurement uncertainty when span is reduced	See RPM4 pressure measurement specifications	1.2.2.1

○ OPERATION

To use the AutoRange function, press **[AutoRange]** and respond to the RPM4's prompts.

- ❶ **Select AutoRange measurement mode:** The screen is identical in appearance and function to the **[MODE]** screen (see Section 3.3.3). The choice of measurement modes offered reflects all the Q-RPT types available (Axxx, Gxxx, BGxxx) in the RPM4 system, not just the active Q-RPT.



Differential pressure measurement mode (see Section 3.3.3.1) is not available in AutoRange.

- ❷ **Select pressure unit of measure:** The screen is identical in appearance and function to the **[UNIT]** screen (see Section 3.3.2).



Altitude units of measure (m, ft) are not available for AutoRange.

- ❸ **Enter the AutoRange full scale pressure:** Enter the full scale pressure value in the **<----->** entry field and press **[ENT]**. If the full scale value entered cannot be covered by any of the Q-RPTs available, an error message appears. If the full scale value can be covered, AutoRange proceeds to the range display.

- ❹ **View proposed AutoRange range:** The proposed AutoRange range screen is:

1. Indication that this is a screen of the proposed AutoRange range.
2. Designator and position of the Q-RPT that AutoRange has selected to cover the AutoRange full scale and measurement mode.
3. Pressure unit of measure specified in AutoRange.
4. AutoRange full scale pressure in gauge mode and absolute mode if available. Absolute mode only if AutoRange measurement mode is absolute and full scale is less than 100 kPa (14.5 psi). Gauge mode only if the Q-RPT is a Gxxx or BGxxx or an Axxx with absolute mode turned off.

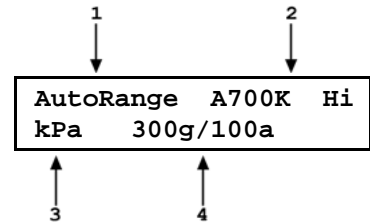

If the RPM4 has two Q-RPTs and you would like to select the other one for the AutoRange, the cursor control keys may be used to toggle between Q-RPTs selections if both Q-RPTs can handle the specified AutoRange.

- ❺ **Accept proposed AutoRange:** To accept the proposed AutoRange and go to the MAIN RUN screen with the AutoRange range active, press **[ENT]** or **[AutoRange]**. To modify the AutoRange full scale, measurement mode or pressure unit of measure, use **[ESC]** to back through the AutoRange screens and make changes.



To verify or confirm the range from the MAIN RUN screen, use **[+/-]** or **[RANGE]** to view the active range (see Section 3.3.1).



See Table 6 for a listing of all selections and settings affected by AutoRange and their default values.



The BA100K Q-RPT cannot be AutoRanged.

3.3.5 [LEAK CK]

○ PURPOSE

To run an automated leak check routine that determines the leak rate of the system connected to the RPM4 active Q-RPT **TEST(+)** port.

○ PRINCIPLE

The LEAK CHECK function is provided as a means of checking and quantifying the leaks that may be present in the system connected to the RPM4's active Q-RPT test port.

The principle of the LEAK CHECK function is the measurement of the natural decrease or increase of pressure in a fixed volume over time. The LEAK CHECK function allows a leak check time to be set. The total pressure change and the average rate of change over the leak check time are calculated and displayed.



In differential pressure measurement mode (see Section 3.3.3.1), the leak check measurement is based on the measurement of the differential pressure.

○ OPERATION

To run a leak check, first set the pressure to the desired leak check pressure.



Changing the pressure in a test system causes adiabatic temperature changes in the pressurized medium that need to have dissipated before a valid leak measurement can be made. In general, a 0.5 to 1 minute wait before running a leak check is adequate to allow the adiabatic temperature change to dissipate and valid leak measurements to be made. However, stabilization time may be much longer with liquid test media, and as volume and pressure increases.

To access the LEAK CHECK function, press **[LEAK CHECK]** from the MAIN RUN screen. Select **<1run>** to run a leak test. The display is:

1. Edit field for the time over which the leak rate will be determined, in seconds.

```
Set leak check time:
15 s
```

↑
1

Edit the leak check time if desired (minimum 1, maximum 999 seconds) and press **[ENT]**. Press **[ENT]** again when ready to start the leak test. The leak test display is:

1. Standard MAIN RUN screen first line showing measured pressure.
2. Active Q-RPT position indicator
3. Indication that leak test is running and countdown of time remaining.

```
957.84 kPa a      Hi
Leak testing      13 s
```

↑
3

[ESC] can be used to abort the running leak test. [ENT] while the leak test is running restarts the leak check timer. When the leak check timer countdown has completed, RPM4 beeps three times and the leak check results screen is displayed:

1. Total pressure change from start to finish of leak check time.
2. Indicator of Q-RPT used to run the leak check.
3. Average rate of change of pressure over the leak check time period (ΔP /time in seconds).

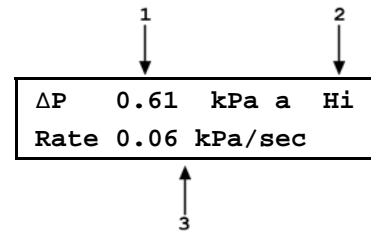

From the leak check results screen, press [ENT] to repeat the leak test.

Press [ESC] to return to leak check main menu and exit to the MAIN RUN screen.

To view the results of the most recently completed leak check, press <2view>. If NO leak check data is stored (i.e., if the RPM4 has never run a leak test or a reset has cleared previous leak test results), the results screen displays <Data NOT available> briefly and returns to MAIN RUN screen. Press [ENT] or [ESC] to return to the MAIN RUN screen.



Leak check is range specific in the sense that a leak check is run using the active range. However, only one set of leak check results is maintained in memory and each leak test completed overwrites the memory. View leak check always shows the results of the last leak check run regardless of the range that is now active. The results screen includes the range indicator to indicate the range in which the leak check was run.

3.3.6 [DISPLAY]

○ PURPOSE

To select, from a variety of choices, the information that is displayed on the second line of the RPM4 display.

○ PRINCIPLE

RPM4 supports a variety of advanced pressure measurement functions that are displayed on the second (bottom) line of the RPM4 display. In summary, the available display functions included are:

AVERAGE Calculates the average pressure measurement over a user specified period of time and displays the average, the standard deviation about the mean and a countdown in seconds to the next average (see Section 3.3.6.1). This function is often used to filter out pressure noise in an unstable system. The magnitude of the noise is quantified by the standard deviation about the mean. A second Avg screen allows the instantaneous pressure values to be viewed during an averaging cycle.

RATE Calculates and displays the current rate of change of pressure in current pressure units/second (see Section 3.3.6.2). This function is a useful indication of the stability of the pressure being measured. It is often used as an indication of positive or negative leak rate and as a go/no go criterion of when to take data when comparing RPM4 and a device under test, for example in a calibration. Rate is used by the Ready/Not Ready function to determine when a Ready condition exists (see Section 3.2.1).

DEVIATION Continuously calculates and displays the difference between the pressure measured by RPM4 and a target pressure entered by the user (see Section 3.3.6.3). This function is useful in monitoring the evolution of pressure around and/or away from a desired set point.

- RPT** If the RPM4 has two Q-RPTs, allows pressure measurement from the two RPTs to be displayed simultaneously (see Section 3.3.6.4). This function is particularly useful in dual Q-RPT RPM4s with independent **TEST** ports to monitor two separate pressures simultaneously. It is also used to when the Hi Q-RPT is in differential measurement mode, to observe the line pressure measured by the Lo Q-RPT.
- HI/LO** Records and displays maximum and minimum pressures measured (see Section 3.3.6.5). This function is used to keep track of the minimum and maximum pressure observed in a system over a period of time or to monitor if a pressure min/max limit has been exceeded..
- FREEZE** Captures and displays the pressure measured by the active range of RPM4 when the **[ENT]** key is pressed (see Section 3.3.6.6). This function is useful to record the pressure present at the time of an operator observed trigger event, for example when the needle of an analog gauge was on the nominal point or when a switch activates.
- CLEAN** Blanks out the second line of the display (see Section 3.3.6.7). This function is used when a simple display of pressure measured by the RPM4 active range without additional information is desired.

○ OPERATION

To set the DISPLAY function press **[DISPLAY]** from the main run screen.

The display is:

1avg	2rate	3dev	4RPT
5HiLo	6freeze	7clean	

The cursor is on the active DISPLAY function. Selecting a display function returns to the main run screen with the selected function active.

Display menu choices include:

- <1avg>** Display average pressure and standard deviation. Specify averaging time period (see Section 3.3.6.1).
- <2rate>** Display pressure rate of change (see Section 3.3.6.2).
- <3dev>** Display deviation of the measured pressure from a target value and specify the target value (see Section 3.3.6.3).
- <4RPT>** Display the pressure measured by the second Q-RPT in RPM4s with two Q-RPTs (see Section 3.3.6.4).
- <5HiLo>** Display the maximum and minimum pressure observed since HiLo reset (see Section 3.3.6.5).
- <6freeze>** Capture and display the value measured when **[ENT]** is pressed (see Section 3.3.6.6).
- <7clean>** Leave the second line of the display blank (see Section 3.3.6.7).



The DISPLAY selection is NOT range specific. A DISPLAY selection made in one range applies to all ranges.



The default DISPLAY function is Rate which causes the second line of the display to show "R" followed by the current rate of change of pressure in current pressure units per second. The default DISPLAY function in differential mode is RPT.



When RPM4 is initialized as an external device to a PPC3 pressure controller, the RPM4 front panel keypad is locked out and the second line of the display becomes:

- <PPC3 EXT DEV: IDLE> (if RPM4 is initialized by PPC3 but not currently in use)
- <PPC3 EXT DEV: ACTIVE> (if RPM4 is initialized by PPC3 and is currently in use)

After using an RPM4 as an external device for a PPC3, cycle power to return to the previous RPM4 settings, restore front keypad capability and return to the normal main run screen.

3.3.6.1 AVG (AVERAGE)

○ PURPOSE

To activate the Average DISPLAY and/or adjust the period of time over which averaging occurs.



See Section 3.3.6. ○ Principle.

○ OPERATION

To access the Average DISPLAY, press **[DISPLAY]**, **<1Avg>**. The display is:

1. Edit field for averaging period in seconds. Default is 20. Minimum 1, maximum 999.

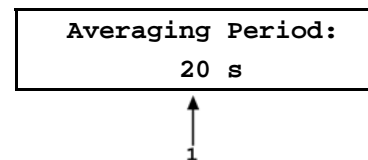

Edit the averaging time period if desired. Pressing **[ENT]** returns to the main run screen with the Average DISPLAY active.

With the Average DISPLAY active the main run screen is:

1. Average measured over last completed averaging period.
2. Standard deviation of last completed averaging period.
3. Countdown in seconds until completion of on-going averaging period.

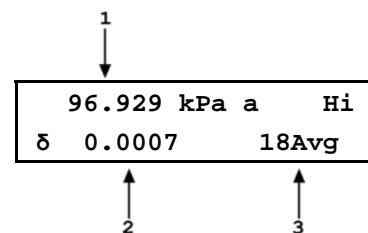

The Average DISPLAY has a second screen that allows the instantaneous pressure readings to be viewed while an averaging cycle is running. The instantaneous Average screen is:

1. Instantaneous pressure values at RPM4's normal update rate.
2. Current rate of change of pressure in pressure units/second.
3. Countdown in seconds until completion of on-going averaging period.

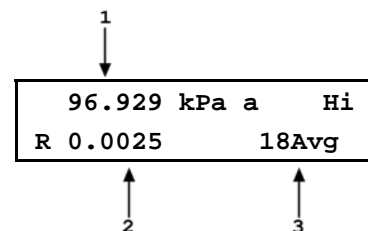

The **[+/-]** key toggles between the main run Average screen and the instantaneous values Average screen.



Pressing [ENT] while in the Average DISPLAY aborts the current averaging period and causes a new one to begin. [ENT] can thus be use to trigger a new averaging period on demand.



In the Average DISPLAY the Ready/Not Ready indication applies to the result of the previous averaging period (see Section 3.2.1). <Ready> indicates that all readings during the previous averaging period met the stability criterion. <Not Ready> indicates that one or more readings were outside of the stability criterion.



Changing the pressure unit of measure, measurement mode or range while the averaging screen is active, starts a new averaging period.



To go to a DISPLAY other than Average, press [DISPLAY] and make a new DISPLAY choice (see Section 3.3.6).

3.3.6.2 Rate

○ PURPOSE

To activate the Rate DISPLAY.



See Section 3.3.6 [DISPLAY], ○ Principle.



The AutoTest function (see Section 3.3.10) to AutoRange RPM4 based on DUT characteristics and run an automated test sequence is accessed by pressing [ENT] from the Rate run screen.

○ OPERATION

To activate the Rate DISPLAY press [DISPLAY], <2Rate>. Pressing <2Rate> returns to the main run screen with the Rate DISPLAY active.

With the Rate DISPLAY active the main run screen is:

1. Current rate of change of pressure in current pressure units per second.

```

99.1135 psi a Hi
R 0.0001/sec

```



The Rate DISPLAY is different and separate from the stability setting which is used to set the stability criterion on which the Ready/Not Ready indication is based (see Sections 3.4.3 and 3.2.1). The Rate DISPLAY only causes the current rate of change to be displayed and has NO affect on the stability setting or the Ready/Not Ready condition.



The Rate DISPLAY is the default display except in differential measurement mode in which the default DISPLAY is RPT.



To go to a DISPLAY other than Rate, press [DISPLAY] and make a new DISPLAY choice (see Section 3.3.6).

3.3.6.3 Dev (Deviation)

○ PURPOSE

To activate the Deviation DISPLAY and/or set the deviation target value.



See Section 3.3.6 [DISPLAY], ○ Principle.

○ OPERATION

To activate the Deviation DISPLAY press [DISPLAY], <3Dev>. The display is:

Target: 100.0000 psi a

Edit the desired target value. Pressing [ENT] returns to the main run screen with the Deviation DISPLAY active using the entered target value.



The target value is the value from which deviations (D) are measured by the Deviation DISPLAY following:

$$D = \text{current pressure} - \text{target pressure}$$

With the Deviation DISPLAY active the main run screen is:

1. Deviation of current pressure from the target value.
2. Target value.

99.1135 psi a zH3
D -0.8865 T100.0000

↑
↑
1
2



Pressing [ENT] from the main run screen when the Deviation DISPLAY is active goes directly to the Target editing screen. This allows the target value to be changed without going through the DISPLAY menu.



If the pressure measurement unit or mode is changed while the Deviation DISPLAY is active the target value remains at the same numerical value. It is NOT converted.



To go to a DISPLAY other than Deviation, press [DISPLAY] and make a new DISPLAY choice (see Section 3.3.6).

3.3.6.4 RPT

○ PURPOSE

To activate the RPT DISPLAY.



See Section 3.3.6, ○ Principle.



The RPT DISPLAY is only available in RPM4s with two Q-RPTs.

○ OPERATION



For the sake of clarity, when describing the RPT DISPLAY, the Q-RPT displayed on the top line of the display when the RPT function is selected is referred to as the “active” Q-RPT. The other Q-RPT to be displayed on the second (bottom) line of the RPM4 display is referred to as the “inactive” Q-RPT. It is “inactive” in the sense that all RPM4 functions and settings such as UNIT and RES still apply to the “active” Q-RPT. To make changes to the “inactive” Q-RPT, for example to change its measurement units, it must be made the active Q-RPT by a conventional range change (see Section 3.3.1). In differential pressure measurement mode, the Hi Q-RPT is always the “active” Q-RPT.

To activate the RPT DISPLAY, press **[DISPLAY]**, **<4RPT>**. Operation returns to the MAIN RUN screen with the inactive Q-RPT displayed on the display’s bottom line. The range of the inactive Q-RPT is always the default range, not an AutoRanged range (see Section 3.3.4).



If the RPM4 has only one Q-RPT, **<Not available with single RPT>** displays momentarily and operation returns to the main run screen when **[DISPLAY]**, **<4RPT>** is pressed.



If the RPM4 is in parallel (**<HL>**) (see Section 3.5.7.3) mode in which both Q-RPTs are used simultaneously, when **<4RPT>** is selected, the Q-RPT to display on the lower display line must be specified. The Q-RPT specific settings of the Q-RPT displayed in the lower display line (measurement mode, unit of measure, resolution, etc.) can only be changed by making that Q-RPT active.

With the RPT DISPLAY active the main run screen is:

1. Active RPT display.
2. Inactive RPT display with Ready/Not Ready indicator on far left.

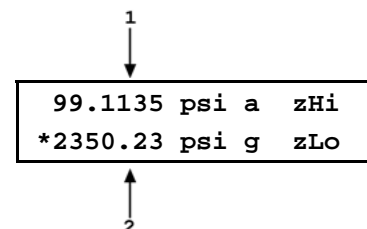



If the inactive RPT is equipped with SDS Self Defense System (see Section 3.2.7), SDS will almost certainly be CLOSED when the RPT DISPLAY is activated. SDS can be OPENED on the inactive RPT using [SPECIAL], <4SDS> (see Section 3.5.4). In differential or parallel measurement mode, SDS can be opened simultaneously on both Q-RPTs using [SDS] (see Section 3.3.8).



The RPT DISPLAY is the default display in differential measurement mode.



When the RPT display is active, executing a range change to a range on the inactive Q-RPT makes the inactive Q-RPT the active Q-RPT. The DISPLAY defaults back to Rate (Section 3.3.6.2).



To go to a DISPLAY other than RPT, press [DISPLAY] and make a new DISPLAY choice (see Section 3.3.6).

3.3.6.5 Hi/Lo

○ PURPOSE

To activate the Hi/Lo DISPLAY.



See Section 3.3.6, ○ Principle..

○ OPERATION

To activate the Hi/Lo DISPLAY press [DISPLAY], <5Hi/Lo>. Pressing <5Hi/Lo> resets the Hi/Lo values and returns to the main run screen with the Hi/Lo DISPLAY active.

With the Hi/Lo DISPLAY active the main run screen is:

1. Highest pressure observed since Hi/Lo reset.
2. Lowest pressure observed since Hi/Lo reset.

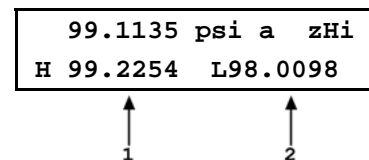

The Hi/Lo values change each time a new Hi or Lo pressure is observed.



The Hi/Lo record can be reset at any time by pressing [ENT]. This allows a Hi/Lo reset without going back through the DISPLAY menu.



If the pressure measurement unit, mode or range is changed while the Hi/Lo DISPLAY is active, Hi/Lo resets.



To go to a DISPLAY other than Hi/Lo, press [DISPLAY] and make a new DISPLAY choice (see Section 3.3.6).

3.3.6.6 Freeze

○ PURPOSE

To activate the Freeze DISPLAY.



See Section 3.3.6, ○ Principle.

○ OPERATION

To activate the Freeze DISPLAY press **[DISPLAY]**, **<6Freeze>**. Pressing **<6Freeze>** returns to the main run screen with the Freeze DISPLAY active.

With the Freeze DISPLAY active the main run screen is:

1. Pressure measured by active range of RPM4 when [ENT] was pressed (displays 0.00 by default when Freeze DISPLAY is first activated).

99.135 psi a zHi
F 99.2133



Pressing **[ENT]** causes the current pressure measured by the active RPM4 Q-RPT to be captured and displayed.



If the pressure measurement unit, mode or range is changed while the Freeze DISPLAY is active, the Freeze value defaults back to zero.



To go to a DISPLAY other than Freeze, press **[DISPLAY]** and make a new DISPLAY choice (see Section 3.3.6).

3.3.6.7 Clean

○ PURPOSE

To activate the Clean DISPLAY.



See Section 3.3.6, ○ Principle..



The AutoTest function (see Section 3.3.10) to AutoRange RPM4 based on DUT characteristics and run an automated test sequence is accessed by pressing **[ENT]** from the Rate run screen.

○ OPERATION

To activate the Clean DISPLAY press **[DISPLAY]**, **<7Clean>**. Pressing **<7Clean>** returns to the main run screen with the Clean DISPLAY active.

With the Clean DISPLAY active the main run screen is:

1. Conventional main run screen first line.
2. "Clean" second line.

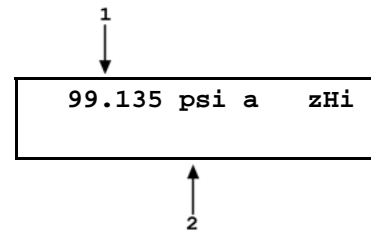

To go to a DISPLAY other than Clean, press **[DISPLAY]** and make a new DISPLAY choice (see Section 3.3.6).

3.3.7 [HEAD]

○ PURPOSE

To cause a pressure fluid head correction to be added to or subtracted from the pressure measured by the RPM4 reference pressure transducer in order to predict the pressure at a height other than the RPM4's reference level.

○ PRINCIPLE

RPM4 measures gauge or absolute pressure at the height of the rear panel **TEST(+)** port. Frequently, when performing a calibration or test, the device or system under test is at a different height than the RPM4's **TEST(+)** port. This difference in height, frequently called **head**, can cause a significant difference between the pressure measured by the RPM4 at its **TEST(+)** port height and the pressure actually applied to the device under test which is at a different height. In this case, it is useful to make a head correction to the pressure measured by the RPM4 in order to predict the pressure actually applied at a different height.

RPM4 can accurately determine "head" pressures for gases (nitrogen, helium and air) and liquids (oil, water) as the pressurized medium. In calculating the head value, standard gravity (9.80665 m/s^2) is used. Gas densities are calculated from the selected gas's standard density correcting for temperature of 20°C and the measured pressure using the gas's compressibility factor to 100 MPa (15 000 psi) and extrapolated above 100 MPa. Oil density is taken to be 850 kg/m^3 , the density of typical calibration oils at 20°C. Water density is taken to be 998.2321 kg/m^3 (20°C). A custom liquid density may also be specified.

The **[HEAD]** function key is used to specify the height difference between the RPM4 **TEST(+)** port and another height. Entering a height of zero turns the function off. The height unit and the test fluid are specified by pressing **[SPECIAL]**, **<3Head>** (see Section 3.5.3).



Use of the HEAD function to assure in tolerance measurements is most important in low absolute pressure ranges. Specifying the head height within $\pm 5 \text{ cm}$ (2.5 in.) is adequate to assure that, even in the worst case, the uncertainty on the head correction will be insignificant relative to the tolerance on the measurement.

○ OPERATION

To access the HEAD function, press **[HEAD]**. The display is:

1. Test fluid currently specified for the head correction.
2. Edit field for head height.

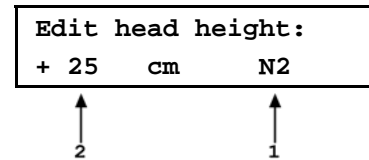

Edit the head height to the desired value. Press **[ENT]** to return to the MAIN RUN screen with the new head correction active. Press **[ESC]** to return with no changes.



The reference height of the RPM4 pressure measurement is the middle of the RPM4 TEST port. The head height should be entered as a positive value if the device or system under test is higher than the RPM4 and negative if it is lower.



The HEAD function is NOT range specific. The HEAD ON or OFF status remains the same as Q-RPTs and ranges are changed. Edits made to the head settings are independent of active range or Q-RPT.



When a head correction is being applied, it is indicated by <h> in the top line of the MAIN RUN screen (see Section 3.1.1). When the head correction is zero, the <h> is not shown.



To change units of head height between inches and centimeters and to change the test fluid species, use **[SPECIAL]**, <3head> (see Section 3.5.3).

3.3.8 [SDS] (SELF DEFENSE SYSTEM)

○ PURPOSE

To CLOSE SDS on all reference pressure transducers (Q-RPTs). To OPEN SDS on the active Q-RPT.



SDS is present only on Q-RPTs designated A7M or lower.



The **[SDS]** key should be used with care to avoid accidentally overpressuring a Q-RPT. Always double check to ensure that the pressure applied to the Q-RPT's TEST port is lower than the Q-RPT's maximum pressure before OPENING SDS.



SDS can be set to permanently be OPEN as if no SDS were installed (see Section 3.5.4.2).

○ PRINCIPLE

SDS is a self defense system to protect RPM4 Q-RPTs from overpressure. SDS CLOSES automatically to protect a Q-RPT that is not active. In a two Q-RPT RPM4, activating one Q-RPT automatically CLOSES SDS on the other Q-RPT. Powering down the RPM4 or energizing it also CLOSES SDS on all Q-RPTs.

When a Q-RPT's module's SDS is CLOSED, the Q-RPT is isolated from the **TEST(+)** port and opened to the **VENT** port. SDS must be OPENED for the pressure applied to the **TEST(+)** port to be measured. The **[SDS]** key is used to OPEN SDS.

The SDS function can also be used to CLOSE SDS as might be desired when leaving RPM4 at rest or when a possible overpressure situation is anticipated. Pressing **[SDS]** always CLOSES any SDS systems that are OPEN.



See Section 3.2.7 for general information on SDS and its principles and Section 5.6, Figure 8 for Q-RPT module schematics.



SDS closed is indicated by <SDS CLOSED> flashing in the current measured pressure display field. When SDS is closed, the Q-RPT is isolated from the TEST(+) port and connected to the VENT port.

○ OPERATION



Though the SDS self defense system includes features to protect Q-RPTs against overpressure, SDS should NOT be considered a fail-safe overpressure protection system. SDS cannot guarantee that overpressure damage will NOT occur. SDS closing automatically may protect an RPT in case of accidental overpressure but conventional measures for overpressure protection should always be used. Damage to Q-RPTs due to overpressure is NOT covered by the RPM4 product warranty even when SDS is present and ON.



The maximum pressure that should be applied to an RPM4 TEST(+) port when SDS is CLOSED is 10 MPa (1 500 psi).



When SDS is CLOSED with a pressure applied, a valve shuts isolating the Q-RPT from the TEST(+) port. Another valve vents the Q-RPT to atmosphere through the VENT port. If the pressure applied at the time SDS is CLOSED is less than 1 700 kPa (250 psi), the VENT valve will open causing sudden release of pressure through the VENT port and returning the Q-RPT to atmospheric pressure. If the pressure applied at the time SDS is CLOSED is greater than 1 700 kPa, the VENT valve may NOT open. In this case, to vent pressure from the Q-RPT module, remove the pressure from the TEST(+) port. This will cause the SDS TEST port isolation valve to open partially, reducing pressure under 1 700 kPa at which time the SDS VENT valve will open (see Section 5.6, Figure 8)



Pressing **[SDS]** always CLOSES any SDS system that is OPEN. In a dual Q-RPT RPM4, even if the active Q-RPT has NO SDS, pressing **[SDS]** CLOSES SDS for the inactive Q-RPT if SDS is present.

Use **[SDS]** to OPEN SDS if it is CLOSED for the active Q-RPT and/or to CLOSE SDS for the active and inactive Q-RPT.

When **[SDS]** is pressed, there are three possible results depending whether the active Q-RPT is SDS equipped and ON (see Section 3.5.4.2), and whether its SDS is OPEN or CLOSED.

1. If the active **Q-RPT IS NOT SDS equipped or its SDS is "full time OFF"** (see Section 3.5.4.2): **<No SDS on RPT>** or **<SDS is OFF and OPEN>** is displayed for 5 seconds and operation returns to the main run screen. If there is a second Q-RPT with SDS, its SDS is CLOSED.
2. If the active **RPT IS SDS EQUIPPED and SDS on the active RPT is OPEN:** SDS is CLOSED and operation returns to the main run screen.
3. If the active **RPT IS SDS EQUIPPED and SDS on the active RPT is CLOSED:** The OPEN SDS routine is presented. The display is :

1. Maximum acceptable pressure of active Q-RPT (always absolute on an Axxx Q-RPT and gauge on a Gxxx Q-RPT).
2. Position designator of Q-RPT for which SDS will be opened.

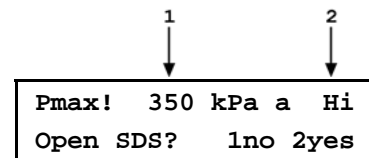

Check that the pressure applied to the **TEST(+)** port does NOT exceed the maximum acceptable value for the Q-RPT. Select **<1no>** to return to the main run screen without OPENING SDS, select **<2yes>** to OPEN SDS and return to the main run screen with SDS OPEN (the active Q-RPT open to the **TEST(+)** port).



Opening SDS with a pressure greater than Pmax! applied to the test port may cause overpressure damage to the Q-RPT.



In differential and parallel measurement modes, opening SDS acts simultaneously on BOTH THE HI AND Lo Q-RPTs (see Section 3.3.8.1). The Pmax! pressure is the Lo RPT. Be sure to check BOTH Q-RPT TEST(+) ports are at a safe pressure before opening SDS.



The [SDS] key is also the [2] key which is pressed to select <2Yes> to OPEN SDS. Thus, SDS can be OPENED by two rapid presses of [SDS]. Use this feature to conveniently OPEN SDS but always check that the pressure connected the TEST(+) port does NOT exceed Pmax! before doing so.



When changing ranges causes a change of active Q-RPT, SDS is automatically CLOSED for the Q-RPT that is being changed from, leaving the inactive Q-RPT with SDS CLOSED.



The Lo and Hi Q-RPTs' SDS, if present, can be controlled directly regardless of which Q-RPT is currently active (see Section 3.5.4).



SDS can be permanently opened so operation is as if SDS were not present (see Section 3.5.4.2).

3.3.8.1 SDS IN DIFFERENTIAL AND PARALLEL MEASUREMENT MODES



In differential and parallel measurement modes, opening SDS opens SDS for BOTH the Hi and Lo Q-RPTs. Before opening SDS, be certain that the pressure applied to both the Hi and Lo RPM4 TEST(+) ports is less than the maximum pressure of the Lo Q-RPT.

Differential (see Section 3.3.3.1) and parallel measurement modes (see Section 3.5.7.3) use two Q-RPTs in one RPM4 to simultaneously. In these modes, function of the **[SDS]** key is adapted to facilitate operation using both Q-RPTs simultaneously. **[SDS]** can be used to OPEN SDS on both the active and inactive Q-RPTs at the same time.

Pressing **[SDS]** always CLOSES any ON and OPEN SDS, as it does in single Q-RPT mode operation. However, if SDS is CLOSED for any and all modules equipped with SDS, pressing SDS goes to the usual OPEN SDS routine which will OPEN SDS for both Q-RPTs.

The display is :

1. Maximum acceptable pressure of the **Lo** Q-RPT (always absolute on an Axxx Q-RPT and gauge on a Gxxx Q-RPT).
2. Position designator of active Q-RPT. **<HL>** in parallel mode, **<Hd>** in differential mode.

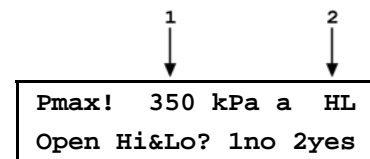

Check that the pressure applied to BOTH the **TEST(+)** ports does NOT exceed the maximum acceptable value for the **Lo** Q-RPT. Select **<1no>** to return to the main run screen without OPENING SDS, select **<2yes>** to OPEN SDS for both Q-RPTs and return to the main run screen with SDS OPEN (the active Q-RPT open to the **TEST(+)** port).

3.3.9 [AUTOZ]

○ PURPOSE

To run the AutoZ function that rezeros the active Q-RPT between full calibrations.



See Section 3.5.1, ○ Principle for a full explanation of the AutoZ function.

○ PRINCIPLE

Run AutoZ is the function by which the current Q-RPT reading is compared to a reference, **P_{std,0}**, at atmospheric pressure to determine a new value of **P_{offset}**. The value of **P_{offset}** is then used by AutoZ to automatically correct the Q-RPT for possible changes in zero over time (see Section 3.5.1, ○ PRINCIPLE).



Running AutoZ in parallel mode (see Section 3.5.7.3) autozeros the Hi and Lo Q-RPTs simultaneously and independently. There are no Zoffset values specific to the HL Q-RPT.

See Section 3.3.9 to run AutoZ.

3.3.9.1 [AUTOZ] IN GAUGE AND NEGATIVE GAUGE MODE

○ PURPOSE

To “rezero” the active Q-RPT in gauge measurement mode.



See Section 3.5.1, ○ Principle for a full explanation of the AutoZ function.

○ OPERATION



For the AutoZ function key to run AutoZ, AutoZ must be turned ON for the active range and measurement mode. AutoZ ON is indicated by <z> to the left of the Q-RPT designator on the first line of the main run screen. AutoZ ON and OFF is set using [SPECIAL], <1AutoZ> (see Section 3.5.1). If AutoZ is OFF for the active Q-RPT, and measurement mode, <AutoZ is off > is displayed when [AutoZ] is pressed.



Running AutoZ in or parallel mode (see Section 3.5.7.3) autozeros both the Hi and Lo Q-RPTs simultaneously.

To run AutoZ in gauge measurement mode, set gauge or negative gauge as the measurement mode (see Section 3.3.3) and press [**AutoZ**] from the main run screen. If the Q-RPT is a Gxxx or BGxxx type, the display is <**Preparing to AutoZ**> for five seconds to allow time for the bypass valve between the **TEST(+)** and **TEST(-)** sides of the Q-RPT to assure zero differential pressure and for the pressure to stabilize (see Section 5.6, Figure 8). <**Running gauge AutoZ**> is displayed briefly before returning to the main run screen.



Before running AutoZ in gauge mode, ensure that the pressure applied to the Q-RPT is truly zero gauge (atmospheric pressure). If running AutoZ in gauge mode results in a zero offset that RPM4 considers unusually large, <Confirm 0 gauge P!> is displayed when AutoZ is pressed. Check that zero gauge pressure is applied to the TEST(+) port and there is no differential pressure across the TEST(+) and TEST(-) ports and press ENTER to continue or ESCAPE to abort.



Allow the RPM4 to stabilize at atmospheric pressure and ambient temperature for 1 to 2 minutes before running AutoZ in gauge mode.

3.3.9.2 [AUTOZ] IN ABSOLUTE MODE

○ PURPOSE

To “rezero” the active Q-RPT in absolute measurement mode



See Section 3.5.1, ○ Principle for a full explanation of the AutoZ function.

○ OPERATION



For the AutoZ function key to run AutoZ, AutoZ must be turned ON for the active Q-RPT and measurement mode. AutoZ ON is indicated by <z> to the left of the range designator on the first line of the main run screen. AutoZ ON and OFF is set using [SPECIAL], <1AutoZ> (see Section 3.5.1). If AutoZ is OFF for the active range, and measurement mode, <AutoZ OFF> is displayed when [AutoZ] is pressed.



Running AutoZ in or parallel mode (see Section 3.5.7.3) autozeros both the Hi and Lo Q-RPTs simultaneously.

To run AutoZ in absolute measurement mode, set absolute measurement mode (see Section 3.3.3) and press [AutoZ] from the main run screen. The display is:

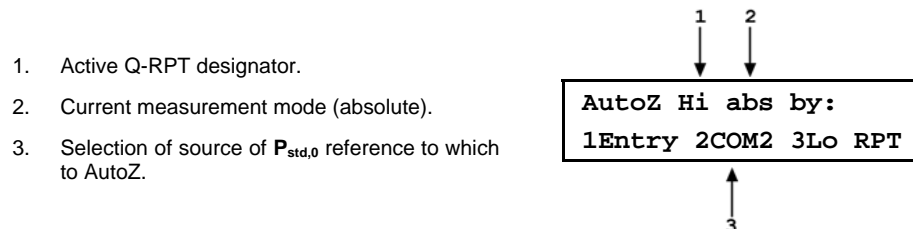

Selecting <1Entry> allows the value of $P_{std,0}$ to be entered from the front panel keypad.

Selecting <2COM2> allows the value of $P_{std,0}$ to be read automatically from another DHI RPMx connected to RPM4’s COM2 communications port.

Selecting <3Lo RPT> is shown only if the active Q-RPT is Hi and there is a Lo Axxx Q-RPT in the RPM4. This selection allows the value of $P_{std,0}$ for the Hi Q-RPT to be read automatically from the RPM4s Lo Q-RPT.



Allow the RPM4 to stabilize at atmospheric pressure and ambient temperature for 10 to 15 minutes before running AutoZ in absolute mode.



If running AutoZ results in a value of P_{offset} that is greater than $\pm 0.005\%$ FS of the span of the Q-RPT that is being AutoZeroed, the Q-RPT and/or the reference used as the source of $P_{std,0}$ may be out of tolerance or the AutoZ process may have been faulty. Before activating a new P_{offset} greater than $\pm 0.005\%$ FS of the active Q-RPT, check to be sure that both the Q-RPT and the reference were in good working order, properly vented to stable atmospheric pressure, at the same height, and reading in the same pressure units when AutoZ was run.



When the run AutoZ selection is made, if a HEAD correction is currently active (see Section 3.3.7) the head correction is momentarily disabled while running AutoZ to avoid “zeroing out” the head value.



The value of P_{offset} is always displayed and entered in Pascal (Pa).

Run AutoZ by Entry

AutoZ by entry allows the value of $P_{std,0}$ (see Section 3.5.1, ○ PRINCIPLE) to be entered directly from the RPM4 front panel. This provides a simple way of AutoZeroing relative to an independent reference device such as a house barometer that does not interface directly with RPM4.

To access run AutoZ by entry press **[AutoZ]**, **<1entry>**. The display is:

1. Real time pressure reading (without head correction), pressure unit of measure and measurement mode of the active Q-RPT.
2. Active Q-RPT position designator.
3. Entry field for the value of $P_{std,0}$ in the current pressure unit of measure.

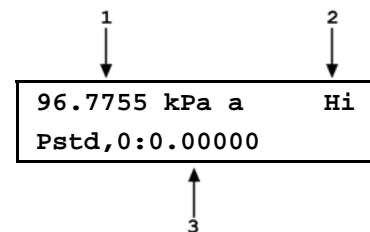

Enter the value of the AutoZ reference ($P_{std,0}$) in the same unit of measure as the top line display and press **[ENT]**. RPM4 logs the reading and calculates a new AutoZ offset value. The next display is:

Press **[ENT]** to activate the new value of P_{offset} or **[ESC]** to start over with entry of a new AutoZ reference ($P_{std,0}$) value.

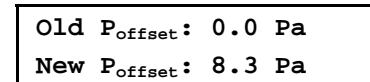

The value of P_{offset} is always in Pascal (Pa). The value of $P_{std,0}$ is entered in the current pressure unit of measure.

Run AutoZ by COM2

AutoZ by COM2 allows the value of $P_{std,0}$ (see Section 3.5.1 ○ Principle) to be read automatically from a **DHI** RPMx connected to the RPM4 COM2 communications port. The RPMx is read and the new P_{offset} is calculated automatically.

To access run AutoZ by COM2 press **[AutoZ]**, **<2COM2>**. The display is:

1. Real time pressure reading (without head correction), pressure unit of measure and measurement mode of the active Q-RPT.
2. Active Q-RPT position designator.
3. Real time reading from the RPMx connected to RPM4's COM2 communications port.

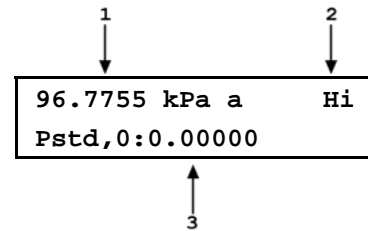

Observe the displayed pressures and verify that they are stable. When ready, press **[ENT]** to cause AutoZ to run. RPM4 logs both readings and calculates a new AutoZ offset value. The display is:

Press **[ENT]** to activate the new value of **P_{offset}** or **[ESC]** to start over.

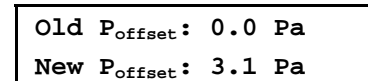

For RPM4 to communicate with an RPMx connected to its COM2 port, the RPM4 and the RPMx RS-232 interfaces must be set up properly (see Section 3.5.2). If, the RPM4 is unable to communicate with an RPMx via COM2 when running AutoZ by COM2, it times out after 6 seconds and displays **<RPM NOT detected>**.



The value of **P_{offset}** is always displayed and entered in Pascal (Pa).

Run AutoZ by Lo RPT

AutoZ by Lo RPT is available only if the active Q-RPT is the Hi Q-RPT and there is an Axxx Lo Q-RPT. AutoZ by Lo RPT allows the Lo Q-RPT in an RPM4 to serve as the AutoZ reference (source of **P_{std,0}**) (see Section 3.5.1, ○ PRINCIPLE). The Lo Q-RPT is read and the new **P_{offset}** is calculated automatically.

To access run AutoZ by Lo RPT press **[AutoZ]**, **<3Lo RPT>**. The display is:

1. Real time pressure reading (without head correction), pressure unit of measure and measurement mode of the active Q-RPT.
2. Active Q-RPT position designator.
3. Real time reading from the Lo Q-RPT.

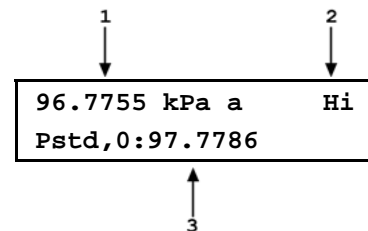

Observe the displayed pressures and verify that they are stable. When ready, press **[ENT]** to cause AutoZ to run. RPM4 logs both readings and calculates a new AutoZ offset value. The display is:

Press **[ENT]** to activate the new value of **P_{offset}** or **[ESC]** to start over.

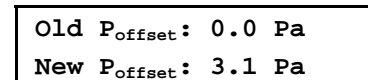

The value of **P_{offset}** is always displayed and entered in Pascal (Pa).

3.3.9.3 AUTOZ IN DIFFERENTIAL MODE

○ PURPOSE

To compensate for the offset between the Hi Q-RPT and the Lo Q-RPT at the operating “line pressure” in differential measurement mode.



See Section 3.5.1, ○ Principle for a full explanation of the AutoZ function.

○ OPERATION



For the AutoZ function key to run AutoZ, AutoZ must be turned ON for the active range and measurement mode. AutoZ ON is indicated by <z> to the left of the Q-RPT designator on the first line of the main run screen. AutoZ ON and OFF is set using [SPECIAL], <1AutoZ> (see Section 3.5.1). If AutoZ is OFF for the active Q-RPT, and measurement mode, <AutoZ is off > is displayed when [AutoZ] is pressed.

To run AutoZ in differential measurement mode, set differential as the measurement mode (see Section 3.3.3) and press [**AutoZ**] from the main run screen. <Running differential AutoZ> is displayed briefly before returning to the main run screen.



Before running AutoZ in differential mode, set the “line pressure” at which the differential measurements will be made and assure that a common pressure is applied to both Q-RPTs. If running AutoZ in differential mode results in a zero offset that RPM4 considers unusually large, <Confirm 0 DP> is displayed when AutoZ is pressed. Check that zero differential pressure is applied across the Hi and Lo TEST(+) ports and press ENTER to continue or ESCAPE to abort.



Allow the RPM4 to stabilize at atmospheric pressure and ambient temperature for 2 to 3 minutes before running AutoZ in differential mode.

3.3.10 [ENT] (RUN AUTOTEST)

○ PURPOSE

To run the AutoTest function which AutoRanges the RPM4 and runs a calibration test based on user entries of pressure unit, measurement mode, full scale, increment and DUT tolerance.



Run AutoTest is accessed by pressing [ENT] from the Rate or Clean DISPLAY mode (see Section 3.3.6.2). In other DISPLAY modes, the function of [ENT] is specific to the mode.

○ PRINCIPLE

This feature not available at the time of release of this manual. Check www.dhstruments.com for new RPM4 embedded software releases and manual updates.

○ OPERATION

Feature not available at the time of release of this manual.

3.4 [SETUP]

○ PURPOSE

[SETUP] accesses a menu of functions and features commonly used in setting up and using RPM4.

○ OPERATION

To access the SETUP menu, press [SETUP] from the MAIN RUN screen. The display is:

1range 2res 3stab
4UL 5ATest

SETUP menu choices include:

- <1range> Save and delete ranges created by AutoRange (see Section 3.4.1).
- <2res> Adjust the resolution of pressure displays (see Section 3.4.2).
- <3stab> Adjust the pressure stability test that is the criterion for the *Ready/Not Ready* indication (see Section 3.3.3).
- <4UL> Adjust upper and lower pressure limit alarms (see Section 3.4.4).
- <5ATest> View data files resulting from running QDUT AutoTests (See Section 3.4.5).

3.4.1 <1RANGE>

○ PURPOSE

Save AutoRange ranges and associated settings for recall. Delete previously saved AutoRange ranges.

○ PRINCIPLE

The RPM4 AutoRange function creates a range and automatically sets various operating parameters proportionally to the range (see Section 3.3.4). Operating settings can then be changed by the user. Many operating settings are specific to the current range (see Table 4).

[SPECIAL], <1range> allows the AutoRange range and associated settings to be saved for recall using the [RANGE] key (see Section 3.3.1). This can avoid having to recreate frequently used ranges and settings.

[SPECIAL], <1range> is also used to delete ranges that have been saved but are no longer needed.

3.4.1.1 SAVING AN AUTORANGE RANGE

○ OPERATION

To save a range created by AutoRange, the range must be the active range. Use AutoRange to create the range (see Section 3.3.4) and then make any desired feature and setting adjustments.

Once the AutoRange range is set up as desired, press **[SETUP]**, **<1range>**, **<1save>**. The display is:

1. Indication that this is a range to be saved.
2. Designator and position of the Q-RPT used by the range to be saved.
3. Pressure unit of measure of the range to be saved.
4. Full scale pressure of the range to be saved in gauge mode and absolute mode if available.

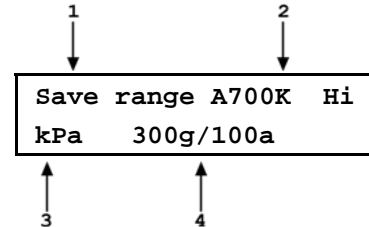

Press **[ENT]** to save the range or **[ESC]** to return to the MAIN RUN screen without saving the range.



Default (<DF>) Q-RPT ranges cannot be saved. They are permanent.

Duplicate AutoRange ranges cannot be saved. A duplicate AutoRange range is a range that has the same measurement mode and full scale and uses the same Q-RPT as a range that has already been saved.

3.4.1.2 DELETING AUTORANGE RANGES

○ OPERATION

To delete a single saved AutoRange range, press **[SETUP]**, **<1range>**, **<2delete>**. If there are any saved ranges available to delete, the display is:

1. Indication that the cursor control keys may be used to toggle through the saved ranges to select the one to be deleted.
2. Designator and position of the Q-RPT used by the range to be deleted.
3. Pressure unit of measure of the range to be deleted.
4. Full scale pressure of the range to be deleted in gauge mode and absolute mode if available.

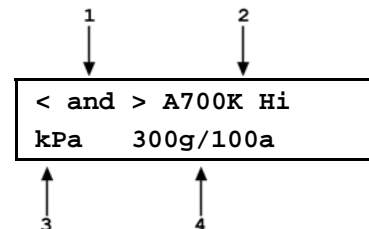

Use the cursor control keys to toggle through the ranges available to be deleted. When the desired range to be deleted is displayed, press **[ENT]**. If you are sure you want to delete this range, press **[ENT]** again in response to the **<Delete?>** query. **[ESC]** returns to the **<AutoRange:>** screen without deleting a range.

To delete all of the saved AutoRange ranges, press **[SETUP]**, **<1range>**, **<3delete all>**. If you are sure you want to delete all the ranges, respond **<1yes>** to the **<Delete all saved ranges?>** query. If not, respond **<2no>**.

3.4.2 <2RES> (RESOLUTION)

○ PURPOSE

To set the resolution with which measured pressures and other pressure indications and settings are displayed.

○ PRINCIPLE

The resolution with which RPM4 displays pressure values can be adjusted. This feature can be used to reduce the resolution when lower precision measurements are being made and excess resolution might confuse or distract the operator.

The resolution setting determines the number of digits with which pressure is displayed. The resolution is calculated based on the span of the range and then rounded to the furthest

digit to the right. For example, resolution of 0.001 % on a range of 150 kPa is $150 \times 0.001 \% = 0.0015$ which is rounded down to 0.001 kPa.



Default resolution is 10 ppm of active range span. Resolution is set automatically by AutoRange (see Section 3.3.4).

○ OPERATION

To access the resolution function, press **[SETUP]**, **<2res>**. The display is:

Display resltn:	Hi
0.0010 %FS	< and >

Use the cursor control keys to set the desired level of resolution. Press **[ENT]** to return to the MAIN RUN screen with the new resolution setting active or **[ESC]** to make no changes.



The resolution setting is range specific. A resolution setting made in one range does NOT affect other ranges.



The measured pressure resolution is fixed for altitude units at 1 m in meters and 1 ft in feet.



The maximum resolution setting is limited in AutoRange ranges that are less than 10% of the Q-RPT default full scale.

3.4.3 <3STAB>

○ PURPOSE

To view and/or adjust the stability test that is the Ready/Not Ready criterion for the active RPT and range.



See Section 3.2.1 Pressure Ready/Not Ready Indication.

○ PRINCIPLE

RPM4 continuously monitors the rate of change of pressure measured by the active RPT and range and compares this rate to the stability limit to make a Ready/Not Ready determination (see Section 3.2.1 Pressure Ready/Not Ready Indication). The stability function allows the stability limit to be adjusted by the user to increase or decrease the stability required for a Ready condition to occur.



The default stability limit is $\pm 0.005\%$ FS of the active range.



The stability limit is separate and different from the Rate DISPLAY function (see Section 3.3.6.2) which allows the current rate of change of pressure to be displayed.

○ OPERATION

To access the stability setting adjustment, press **[SETUP]**, **<3stab>**. The display is:

Stability:	Hi
0.020 Pa	

Edit the desired stability limit setting if desired. **[ENT]** activates the stability limit for the active range and returns to the main run screen. Press **[ESC]** to return to the MAIN RUN screen with no change to the stability limit.



The stability setting is range specific. A stability setting made in one range does NOT affect other ranges.

3.4.4 <4UL> (UPPER LIMIT)

○ PURPOSE

To set the upper and lower pressure limit values for a pressure range and measurement mode.

○ PRINCIPLE

The UPPER LIMIT function provides the user with settable pressure limits at which an alarm sounds. Absolute and gauge measurement modes (see Section 3.3.3, ○ PRINCIPLE) have upper limits only. Negative gauge mode and the BA100K also have a lower limit.

When the limit is reached, RPM4's beeper sounds intermittently as long as pressure is outside the limit.

The UPPER LIMIT function has two purposes. First, when UL is set to its default value, it serves as a warning that the maximum pressure of the active range (and lower pressure in negative gauge mode) is about to be exceeded. Second, UL can be set by the user to a value other than the default value to provide an alarm that a specific pressure limit has been exceeded. This feature is often used to help protect an external device or system on which RPM4 is being used to measure pressure. For example, it might be set just over the full scale of a device under test (DUT) that is being calibrated. Note that using AutoRange automatically sets the UL to just above the AutoRange full scale (see Section 3.3.4).



The default upper limit is 105 % of AutoRange span or 102 % of Q-RPT default (maximum range, whichever is lower). The default lower limit (negative gauge mode only) is -110 kPa (-16 psi), except with the BG15K Q-RPT in which the default lower limit is the negative equivalent of the upper limit. The default lower limit of the BA100K Q-RPT is 66 kPa (9.6 psi).



In parallel measurement mode (see Section 3.5.7.2), the default and maximum UL is the UL of the Lo Q-RPT.

In differential measurement mode (see Section 3.3.3.1), UL has upper and lower limits. The default upper differential UL is the maximum pressure of the Hi Q-RPT. The default lower UL is the negative value of the upper limit.

In differential measurement mode, the ULs on the Lo Q-RPT and Hi Q-RPT default range are also active so that line pressure (Lo Q-RPT) and total pressure (Hi Q-RPT) upper limit can be set and monitored in addition to a differential limit.

○ OPERATION

To view or edit upper and lower limits press **[SETUP]**, **<4UL>**.

If the current measurement mode is absolute or gauge, there is an upper limit only. The display is:

1. Entry field for upper limit value in active pressure unit of measure and measurement mode.

Upper limit:	Hi
204.000 kPa a	



Edit the upper limit value as desired. The maximum upper limit is 105 % of span in an AutoRange range or 102 % of default Q-RPT full scale, whichever is smaller. Press **[ENT]** to return to the MAIN RUN screen with the new upper limit active. Press **[ESC]** to return to the MAIN RUN screen with no change to the upper limit.

If the current measurement mode is negative gauge, there is an upper limit and a lower limit. The display is:

1. Entry field for upper limit value.
2. Entry field for lower limit value and active range pressure unit of measure and measurement mode indication.

Upper: 104.00	Hi
Lower: -110.00	kPa g



Edit the upper and lower limit values as desired. Use the cursor control keys to move between the two edit fields. The lower limit must be a negative value. Press **[ENT]** to return to the MAIN RUN screen with the new upper and/or lower limit active. Press **[ESC]** to return to the MAIN RUN screen with no change to the limits.

When the upper or lower limit has been exceeded, the display of current pressure flashes and a buzzer sounds for 3 seconds on/2 seconds off intervals. Change the pressure applied to RPM4 so that it is within the upper and/or lower limit to return to normal operation.



Upper limit values are specific to each range and measurement mode. Be careful not to assume that the upper limit set in one measurement mode will apply to the other. For example, if you change the upper limit in gauge mode, the upper limit will not be changed in negative gauge mode.



Upper limits are always specified and displayed in the current pressure unit except for altitude units. When in altitude units, upper limits are expressed in kPa if the altitude unit is meters (m) and psi if the altitude unit is feet (ft).



In Hi Q-RPT differential mode (see Section 3.3.3.1) there are two UL values for the Hi Q-RPT. One is the upper and lower limits for differential pressure, with a default value equal to the span of the Lo RPT. The other is the UL on the base mode of the Hi Q-RPT DF range to monitor the maximum pressure on the Hi Q-RPT. In differential mode, the Lo Q-RPT UL is also active to provide monitoring of the differential mode line pressure.

3.4.4.1 OVER PRESSURE FUNCTION

In addition to the UL function, RPM4 has an over pressure function.

The over pressure function executes when a Q-RPT measures a pressure that is 104 % of its default span. The G15K and BG15K Q-RPTs also have a negative over pressure function. The negative over pressure function executes when the Q-RPT measures a pressure less than - 17.5 kPa (- 2.3 psi).

The over pressure function causes the measured pressure display to flash. If the Q-RPT module is equipped with SDS, SDS closes shutting off the **TEST(-)** port (see Section 3.2.7). If the Q-RPT is a Gxxx or BGxxx, the **TEST(+)/TEST(-)** bypass valve is opened (see Section 5.6, Figure 8). The overpressure function also logs the time and date of the overpressure condition in both user and factory logs to assist in incident diagnosis (see Section 3.5.7.5).

To recover from an overpressure condition, cycle RPM4 power. Be sure to correct the condition that caused the overpressure before cycling power.

3.4.5 <5ATEST>

This feature not available at the time of this manual's release. Check www.dhstruments.com for new RPM4 embedded software releases and manual updates.

3.5 [SPECIAL]

○ PURPOSE

[SPECIAL] accesses a menu of RPM4 functions and features that are less commonly used or not normally used in regular operation.

○ OPERATION

Press [SPECIAL] from the MAIN RUN screen to access the SPECIAL menu. The display is:

```
1AutoZ 2remote 3head
4SDS 5prefs 6Punit ↓
7intern 8cal 9reset
```



Some screens, such as the SPECIAL menu, go beyond the two lines provided by the display. This is indicated by a flashing arrow in the second line of the display. Press the cursor control keys to move the cursor to access the lines that are not visible or directly enter the number of the hidden menu choice if you know it.

SPECIAL menu choices include:

- <1AutoZ>** Manage AutoZero function for the active Q-RPT (see Section 3.5.1).
- <2remote>** View and edit COM port (RS-232) and IEEE-488 interface settings. Select remote syntax style (see Section 3.5.2).
- <3head>** Set HEAD function fluid and height unit of measure (see Section 3.5.3).
- <4SDS>** To view and set the ON/OFF and OPEN/CLOSED status of SDS for all Q-RPTs.
- <5prefs>** View and set screen saver time, keypad sound frequency, unit ID number, time/date, security protection level (see Section 3.5.5).
- <6Punit>** Customize the [UNIT] key pressure unit of measure selections (See section 3.5.6).
- <7intern>** Access internal functions including on-board barometer viewing, read rate adjustment, parallel measurement mode ON/OFF, direct control of Lo Vent valve(s), incident log viewing (see Section 3.5.7).
- <8cal>** View and adjust RPM4, Q-RPT and barometer calibration coefficients (see Sections 3.5.8, 5.2, 5.3).
- <9reset>** Access RPM4's various reset functions (see Section 3.5.9).

3.5.1 <1AutoZ>

○ PURPOSE

To offset the RPM4 Q-RPT(s) readings relative to a reference value in order to compensate for possible changes in Q-RPT zero between full recalibrations. In differential measurement mode, to compensate for the difference between the reading of the Hi and Lo Q-RPTs at the “line pressure” at which differential measurements are made.



To assure operation within measurement uncertainty specifications (see Section 1.2.2), it is recommended that AutoZ be run (the value of P_{offset} updated) whenever vented in gauge mode, whenever the line pressure is changed in differential mode and at least every 30 days or when RPM4 has been exposed to temperature changes exceeding 15 °C (36 °F) in absolute mode.

○ PRINCIPLE

AutoZ Purpose and Principle

The main component of the change over time of the RPM4 Q-RPTs is change in zero or offset, independent of span. Offsetting or “rezeroing” RPM4 Q-RPTs relative to a reference between recalibrations allows measurement uncertainty specifications to be maintained with less frequent full calibrations. AutoZ is also used to compensate for the difference between the Hi and Lo Q-RPT at the “line pressure” at which differential measurements are made. The RPM4 AutoZero function (AutoZ) provides full on-board support for the rezeroing process to simplify its application by the user.

The AutoZero function uses three values:

1. $P_{\text{std},0}$: The pressure value indicated by the AutoZ reference, the device that is acting as the reference relative to which to offset the RPM4 Q-RPT.

For Axxx (absolute) Q-RPTs in **absolute measurement** mode, the pressure at which AutoZ is performed is normally atmospheric pressure and the $P_{\text{std},0}$ value can be supplied a) by manual entry, b) automatically from a **DHI** RPMx connected to RPM4 COM2 communications port, or c) automatically from an Axxx Lo Q-RPT if one is present in the RPM4.

For Gxxx or BGxxx (gauge) Q-RPTs or Axxx (absolute) Q-RPTs in **gauge measurement** mode, $P_{\text{std},0}$ is always zero (atmospheric pressure) which is supplied by definition when the Q-RPT is vented to atmosphere.

For RPM4s with two Q-RPTs of the same type (Axxx, Gxxx, BGxxx) with the Hi Q-RPT in **differential measurement** mode, $P_{\text{std},0}$ is the pressure indicated by the Lo Q-RPT when the Hi and Lo Q-RPTs are connected to a common pressure.

2. $P_{u,0}$: The pressure reading of the Q-RPT, with no AutoZ offset, at the time AutoZ is performed.
3. $P_{\text{offset,G}}$, $P_{\text{offset,A}}$ and $P_{\text{offset,D}}$: The difference between the reading of the Q-RPT with no AutoZ offset ($P_{u,0}$) and the indication of the AutoZ reference ($P_{\text{std},0}$) for gauge (G), absolute(A) or differential (D) measurement mode:

$$P_{\text{offset}} = P_{u,0} - P_{\text{std},0}$$

P_{offset} represents the difference between the Q-RPT reading ($P_{u,0}$) and the AutoZ standard ($P_{\text{std},0}$). The AutoZ function manages the determination, storage and application of P_{offset} to correct the zero offset in absolute, gauge and differential measurement modes.

When the Q-RPT is calibrated, P_{offset} is set to zero. P_{offset} is then redetermined at regular intervals using the AutoZ function. The most recent value of P_{offset} is applied to the Q-RPT reading to correct for change in zero.

The AutoZ function can be turned ON and OFF. Table 7 summarizes the effect of AutoZ ON and OFF for the three Q-RPT types in different measurement modes.

AutoZ in absolute measurement mode with an Axxx Q-RPT

Q-RPTs with the designation Axxx are intrinsically absolute. They have an evacuated and sealed reference. Axxx Q-RPTs can measure absolute pressure (difference from vacuum).

In absolute measurement mode, the source of $P_{std,0}$ must be an absolute pressure, nominally atmospheric pressure, with uncertainty significantly better than that of the Q-RPT that is being AutoZeroed. For higher range Q-RPTs, this is easily accomplished with a variety of digital barometers or with a Lo Q-RPT in the RPM4. For lower range Q-RPTs, a piston gauge or other standard may be required to provide $P_{std,0}$ with low enough uncertainty.

When using an Axxx (absolute) Q-RPT in absolute measurement mode, with AutoZ ON, absolute pressure is calculated as:

$$P_{abs} = P_u - P_{offset,A}$$

In absolute measurement mode, running the AutoZ function to update the AutoZ value ($P_{offset,A}$), is initiated by the operator using **[AutoZ]**.

AutoZ in gauge and negative gauge measurement modes with an Axxx Q-RPT, dynamic compensation for atmospheric pressure

Q-RPTs with the designation Axxx are intrinsically absolute but they are also used in gauge and negative gauge measurement modes (difference from atmosphere) (see Section 3.3.3, ○ PRINCIPLE). Gauge measurement mode is achieved by subtracting the value of atmospheric pressure from the Q-RPT's absolute reading using AutoZ and by dynamically compensating for changes in atmospheric pressure between opportunities for AutoZ to execute (see Section 3.2.2).

In gauge measurement modes on an Axxx Q-RPT, the value of $P_{std,0}$ is always zero gauge pressure. Zero gauge pressure, by definition, is applied to the Q-RPT when it is vented to atmosphere. In gauge measurement modes, AutoZ is run when initiated by the operator pressing **[AutoZ]** when the RPM4 is vented. This assures regular updating of the $P_{offset,G}$ value corresponding to atmospheric pressure. Gauge pressure is the measured absolute pressure, P_u , minus $P_{offset,G}$.

$$P_{gauge} = P_u - P_{offset,G}$$

When AutoZ is ON, dynamic compensation for atmospheric pressure is also applied to compensate for changes in atmospheric pressure as measured by a barometer (ΔP_{atm}) between AutoZ updates (see Section 3.2.2). The measured gauge pressure is calculated using ΔP_{atm} to correct the value of $P_{offset,G}$.

$$P_{gauge} = P_u - P_{offset,G} - \Delta P_{atm}$$

In gauge measurement mode on an Axxx RPT, running the AutoZ function to update the value of $P_{atm,0}$, is initiated by the operator using **[AutoZ]**. Updating of ΔP_{atm} occurs automatically and continuously.



*When gauge or negative gauge mode is first activated on an Axxx Q-RPT, the value of $P_{offset,G}$ subtracted from the absolute pressure reading to achieve gauge pressure is standard atmosphere of 101.325 kPa. This can cause a large zero error when gauge mode is activated if atmospheric pressure is significantly different from standard atmospheric pressure. When gauge mode is activated, always press **[AutoZ]** to run AutoZ and obtain an actual value of $P_{offset,G}$.*

AutoZ in gauge measurement mode with a Gxxx or BGxxx Q-RPT

Q-RPTs with the designation Gxxx or BGxxx are intrinsically gauge. They have an atmospheric (**TEST(-)**) reference port and measure gauge pressure (difference from atmosphere).

In gauge measurement mode the value of $P_{std,0}$ is always zero gauge pressure. Zero gauge pressure, by definition, is applied to the Q-RPT when it is vented to atmosphere.

When using a Gxxx Q-RPT in gauge measurement mode, with AutoZ ON, gauge pressure is calculated as:

$$P_{gauge} = P_u - P_{offset,G}$$

In gauge measurement modes, AutoZ is run when initiated by the operator pressing [**AutoZ**] when the RPM4 is vented. This assures the regular automated updating of the $P_{offset,G}$ value.

AutoZ in differential measurement mode

RPM4s with two Q-RPTs of the same type (Axxx, Gxxx, BGxxx) support differential measurement mode (see Section 3.3.3.1) in which the measured pressure is the difference between the pressure measured by the Hi Q-RPT and the Lo Q-RPT (Hi – Lo).

In differential measurement mode, the purpose of AutoZ is to compensate for the offset between the Hi and Lo Q-RPT indications at the “line pressure” at which the differential pressure is being measured. The value of $P_{std,0}$ is the pressure indicated by the Lo Q-RPT at the time of AutoZ.

When using an RPM4 with two Q-RPTs in differential measurement mode, with AutoZ ON, differential pressure is calculated as:

$$P_{differential} = P_{Hi} - P_{Lo} - P_{offset,D}$$

In differential measurement mode, AutoZ is run when initiated by the operator pressing [**AutoZ**] when both Q-RPTs of the RPM4 are connected to a common pressure..

AutoZ ON/OFF

The AutoZ function can be turned ON and OFF, separately for gauge, absolute and differential measurement modes. Table 7 summarizes the effect of AutoZ ON and OFF.

Table 7. AutoZ ON and OFF

Q-RPT TYPE	MEASUREMENT MODE	AutoZ STATUS	P_{offset} APPLIED	ΔP_{atm} APPLIED	AutoZ ROUTINE RUNS
Axxx	Absolute	ON	YES	Not Applicable	When initiated by operator
		OFF	NO		Not available
	Gauge or negative gauge	ON	YES	YES	When initiated by operator
		OFF		NO	
Gxxx or BGxxx	Gauge or negative gauge	ON	YES	Not Applicable	When initiated by operator
		OFF	NO		Not available
Any, Hi Q-RPT in dual Q-RPT RPM4	Differential	ON	YES	Not Applicable	When initiated by operator
		OFF	NO		Not available

Recommendations for the Use of the AutoZ Function

The AutoZ function provides a powerful and easy to use tool for improving the stability over time of RPM4 Q-RPTs and maximizing the recalibration interval by compensating for change in zero between full recalibrations. In differential measurement mode, it minimizes the uncertainty in the differential pressure due to the offset between the Hi and Lo Q-RPTs at the

“line pressure”. The following simple recommendations will help assure that you use this feature to best advantage.

- In **gauge and differential measurement** mode: Always leave AutoZ ON when operating.
- In **absolute measurement** mode: Always leave AutoZ ON when operating if the AutoZ routine has been run regularly using a valid atmospheric reference.
- To assure operation within measurement uncertainty specifications (see Section 1.2.2), run AutoZ whenever vented in gauge mode, whenever the line pressure is changed in differential mode and at least every 30 days or when RPM4 has been exposed to temperature changes exceeding 15 °C (36 °F) in absolute mode.
- In **absolute measurement** mode: Run AutoZ only when a reference whose measurement uncertainty is known to be significantly better than that of the Q-RPT to be AutoZeroed is available. Keep range ratios in mind when comparing uncertainty. A ± 0.01 % FS barometer is roughly 10 times better than an ± 0.01 % 1 MPa (150 psi) Q-RPT because the Q-RPT/barometer pressure ratio is 10:1. The measurement uncertainty comparison should be made at 30 % of span for both *standard class* and *premium class* Q-RPTs. Though it may not be practical and generally is not necessary, the best possible reference with which to run AutoZ in absolute measurement mode is a gas operated piston gauge (such as a **DHI PG7601**) applying atmospheric pressure to the RPM4 test port. The best day to day reference is a properly calibrated **DHI RPM4** with a BA100K Q-RPT interfaced directly as an external device to the RPM4 COM2 port.
- In **absolute measurement modes**: Allow the RPM4 to stabilize at atmospheric pressure and ambient temperature for 10 to 15 minutes before running AutoZ.

○ OPERATION



The AutoZ function and values are Q-RPT AND measurement mode (gauge/negative gauge or absolute) specific.



To RUN the AutoZ routine that rezeroes the Q-RPT, use [AutoZ] (see Section 3.3.9).

To access the RPM4 AutoZ function press [**SPECIAL**], <1AutoZ>. The display is:

1. Active Q-RPT designator.
2. Indication of active measurement mode (<abs> for absolute, <gage> for gauge and negative gauge, <dif> for differential).
3. Indication of whether AutoZ is currently ON or OFF for this Q-RPT and measurement mode.

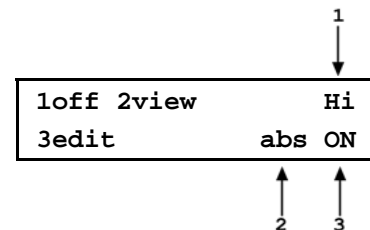

Select <1off> (or <1on>) to change the AutoZ status for the current Q-RPT and measurement mode from ON to OFF or vice versa.



AutoZ ON is indicated by a <z> in the MAIN RUN screen, top line, fourth character from the right. When AutoZ is OFF, the character is blank.

Select <2view> to view the current value of P_{offset} for the active Q-RPT and measurement mode.



P_{offset} should be zero when the RPM4 is new or has just been calibrated. P_{offset} should be roughly equal to atmospheric pressure for an Axxx (absolute) Q-RPT operating in gauge mode.

Select **<3edit>** to edit the value of P_{offset} for the active Q-RPT and measurement mode (see Section 3.5.1.1).



The value of P_{offset} is always displayed and entered in Pascal (Pa).

3.5.1.1 EDIT AUTOZ



The edit AutoZ function should be used with great caution as entering inappropriate values and turning ON AutoZ may result in out of tolerance measurements. In normal operation, the value of the AutoZ offset, P_{offset} , should be changed by running AutoZ using [AutoZ] (see Section 3.3.9). Before editing P_{offset} , see Section 3.5.1, ○ PRINCIPLE.

To edit the current P_{offset} value for the active Q-RPT and measurement mode, press [SPECIAL], <1AutoZ>, <3edit>. The display is:

1. Indication of active measurement mode (<abs> for absolute, <gage> for gauge and negative gauge, <dif> for differential).
2. Active Q-RPT for which P_{offset} is being viewed.
3. Edit field for value of P_{offset} .

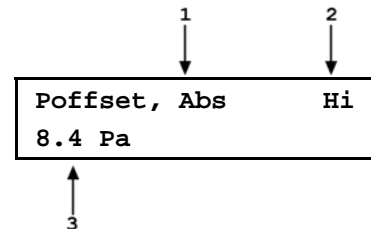

Edit P_{offset} as desired and press [ENT] to activate the new value. Press [ESC] to abandon changes.



The value of P_{offset} is always displayed and entered in Pascal (Pa).

3.5.2 <2REMOTE>

○ PURPOSE

To configure the RPM4 COM1, COM2 and IEEE-488 (GPIB) communication ports. To test COM1 and COM2 communications. To select the remote programming communications format.

○ PRINCIPLE

The RPM4 has two RS-232 communications ports referred to as COM1 and COM2 and a single IEEE-488 (GPIB) port. COM1 or the IEEE-488 port is for communicating with a host computer (see Section 4), and COM2 is reserved for communicating with an external device (e.g. an RPMx, a multimeter, etc.). These ports' settings can be viewed and changed using [SPECIAL], <2remote>.

RPM4 has two remote communications formats, classic and ENHANCED (see Section 4.3). Which of these is active can be selected.

A self test is supplied for RS-232 communications. The self test allows verification that the RPM4 RS232 ports (COM1 and COM2) are operating properly and that a valid interface cable is being used.

○ OPERATION

To access the communications settings, press **[SPECIAL]**, **<2Remote>**.

- Select **<1COM1>** to view and edit COM1 settings (see Section 3.5.2.1.).
- Select **<2COM2>** to view and edit COM2 settings (see Section 3.5.2.1.).
- Select **<3IEEE>** to view and edit IEEE-488 settings (see Section 3.5.2.2).
- Select **<4format>** to select the remote communications command format (see Section 3.5.2.3).
- Select **<5RS232test>** to run the COM1 and COM2 communications test (see Section 3.5.2.4).

3.5.2.1 <1COM1, 2COM2>

The COMx ports can be set for specific communications settings. The settings are baud rate, parity, data bits and stop bits. The available options are:

Baud	300, 600, 1 200, 2 400, 4 800, 9 600, 19 200, 28 800, 38 400
Parity	NONE, ODD or EVEN
Length	7 or 8
Stop Bit	1 or 2

The default is **<2 400, E, 7,1>** for both COM1 and COM2.

The user can also specify one or two termination characters as well as define these characters. These are referred to as "Term1" and "Term2". These define the characters that mark the end of commands that are sent to the RPM4. The RPM4 looks for an ASCII(13) (carriage return) to terminate a received command but responds with both and ASCII(13) (carriage return) and an ASCII(10) (line feed). There are no other options.

3.5.2.2 <3IEEE-488>

The IEEE-488 port's primary address can be set from 1 to 31 in this screen. The factory default value is 10. Secondary addressing is not used or supported. This address must not conflict with the address of any other device on the same IEEE-488 bus.

The receiving terminating character must be a line feed and EOI. Carriage returns are ignored if received. The RPM4 sends a line feed and asserts the EOI line to terminate a reply. These settings are fixed to agree with IEEE Std. 488.2. If you change the address, the IEEE interface will reset (PON) and become idle.

3.5.2.3 <4FORMAT>

The RPM4 has two different syntax formats available for the remote program commands.

The **classic** remote command format is highly intuitive and conforms with previous **DHI** PPC and RPM products.

The **enhanced** remote command format generally uses the same commands as the **classic** format, but in addition it follows the syntax, format, and status reporting features of IEEE Std 488.2.

The details of each format are covered in Section 4.3.

[SPECIAL], **<2remote>**, **<4format>** allows the remote program command syntax to be selected. The cursor is on the active format. Select **<1classic>** or **<2enhanced>** as desired.

3.5.2.4 <5RS232 SELF-TEST>

The RS232 self-test is provided to check the RPM4 COM ports and the interface cable independently of an external device or computer.

If you are having difficulty communicating with RPM4 from a host computer using RS232, the RS232 self test can help establish that the RPM4 COM1 port you are trying to communicate with and the interface cable you are using are good.

To run a self test of the RS232 ports (COM1 and COM2), press **[SPECIAL]**, **<2remote>**, **<5RS232test>**.

The display prompts you to connect COM1 to COM2 using a standard pin-to-pin DB-9F to DB-9M RS232 cable (see Section 4.2.1.1, 4.2.1.3).

Once the cable has been installed, press **[ENT]** to run the self-test. The test is first executed in the COM1→COM2 direction and then in the COM2→COM1 direction.

If the COM1→COM2 test passes: **<PASSED>** displays briefly and the test proceeds to COM2→COM1.

If COM2→COM1 passes: **<PASSED>** is displayed briefly followed by the conclusion, **<The RS232 test has PASSED>**.

If a test fails: Execution is suspended until **[ENT]** is pressed.



The RPM4 RS232 test can fail for three reasons:

1. The RS232 cable being used is incorrect (Section 4.2.1.1, 4.2.1.3 for information on the correct cable).
2. COM1 and COM2 do NOT have the same serial communications settings and therefore cannot communicate together (see Section 3.5.2.1 to set the COM ports).
3. COM1 or COM2 is defective.

The reason for failed communications is almost always a cable or incorrect RS232 interface settings. Be sure that these are correct before concluding that a COM port is defective.

3.5.3 <3HEAD>

○ PURPOSE

To view or change the properties of the HEAD function (see Section 3.3.7) including the unit of measure of length for head height entry and the test fluid type and species for density calculations.

○ OPERATION

From the MAIN RUN screen, pressure **[SPECIAL]**, **<3Head>**.

Select the desired height unit of measure and press **[ENT]**.

Select **<1gas>** or **<2liquid>** depending on the pressurized medium between the RPM4 and the height at which pressure is to be calculated. Select the gas or liquid species. The liquid selection **<3User>**, is to create a custom liquid with a user entered density.

Use **[HEAD]** to set a head height if desired.

3.5.4 <4SDS>

○ PURPOSE

To open and close SDS temporarily for the Hi or Lo Q-RPT or to turn the SDS function ON and OFF full time for the Hi or Lo Q-RPT.



See Section 3.2.7 for complete information on RPM4's SDS (Self Defense System) feature.

○ PRINCIPLE

SDS is a self defense system to protect RPM4 Q-RPTs from overpressure (see Section 3.2.7). Normally, opening and closing SDS is performed automatically by the RPM4 or by the operator using the **[SDS]** key.

[SPECIAL], **<4SDS>** gives further control over the SDS function. This includes: a) the possibility of temporarily opening or closing SDS on either the Hi or Lo Q-RPT (see Section 3.5.4.1), and; b) turning OFF SDS so that it is open full time and RPM4 can be operated as if SDS were not installed (see Section 3.5.4.2).

The temporary opening or closing of SDS allows the SDS open/closed state to be set immediately to the desired state. Following the change, normal automated operation of SDS and control using the **[SDS]** key is still valid. This function is often used to open SDS on the inactive Q-RPT in PRM4s with dual Q-RPTs.

Setting the SDS function to full time OFF eliminates the SDS function completely until is set to full time ON again.

3.5.4.1 <1TEMP OPEN/CLOSE>

○ OPERATION



See Section 3.2.7 for complete information on RPM4's SDS (Self Defense System) feature.

To temporarily open or close the SDS of the Hi or Lo Q-RPT press **[SPECIAL]**, **<4SDS>**, **<1temp open/close>**. If the RPM4 has two Q-RPTs and both have SDS, the Q-RPT must then be selected. The next display is:

The cursor is on the current state of SDS for the designated Q-RPT. Select **<1close>** to close SDS or **<2open>** to open SDS and return to the MAIN RUN screen. **[ESC]** to return without making changes.

SDS temporary:	Hi
1close	2open

If **<2open>** is selected and SDS for the Q-RPT is not already open, the SDS opening screen with indication of the maximum pressure of the Q-RPT is displayed. This is the same screen used when opening SDS using the **[SDS]** key (see Section 3.3.8). Check that the pressure applied to the Q-RPT module **TEST(+)** port does not exceed the Pmax! value before confirming that SDS should be opened.



Opening SDS with a pressure greater than Pmax! applied to the test port may cause overpressure damage to the Q-RPT.

3.5.4.2 <2FULL TIME ON/OFF>

○ OPERATION



See Section 3.2.7 for complete information on RPM4's SDS (Self Defense System) feature.



Turning SDS "full time OFF" for a Q-RPT module eliminates normal SDS operation so that the Q-RPT module TEST(+) port remains open. However, the SDS overpressure function (see Section 3.4.4.1) remains active.

To turn SDS full time ON or OFF for a Q-RPT module, press **[SPECIAL]**, **<4SDS>**, **<2full time on/off >**. If the RPM4 has two Q-RPTs and both have SDS, the Q-RPT must then be selected. The next display is:

The cursor is on the current state of SDS for the designated Q-RPT. Select **<1on>** to set SDS for normal operation and return to the main run screen. Select **<2off>** to open SDS permanently so operation is as if SDS were not installed. **[ESC]** to return without making changes.

SDS full time:	Hi
1on 2off	

If **<2off>** is selected and SDS for the Q-RPT is not already open, the SDS opening screen with indication of the maximum pressure of the Q-RPT is displayed. This is the same screen used when opening SDS using the **[SDS]** key (see Section 3.3.8). Check that the pressure applied to the Q-RPT module **TEST(+)** port does not exceed the Pmax! value before confirming that SDS should be opened.



Opening SDS with a pressure greater than Pmax! applied to the test port may cause overpressure damage to the Q-RPT.

3.5.5 <5PREFS>

○ PURPOSE

To access a menu of RPM4 operational preferences and functions.

○ OPERATION

To access the PREFS menu press **[SPECIAL]**, **<5prefs>**. The display is:

1ScrSvr	2sound	3time
4ID	5level	

The PREFS menu includes:

- <1ScrSvr>** View and change the screen saver activation time (see Section 3.5.5.1).
- <2sound>** View and change the keypress sounds (see Section 3.5.5.2).
- <3time>** View and edit the internal time and date settings (see Section 3.5.5.3).
- <4ID>** View the RPM4 serial number (SN) and view or edit the ID number (see Section 3.5.5.4).
- <4level>** View and set user security level and/or password (see Section 3.5.5.5).

3.5.5.1 <1SCRsvr>

○ PURPOSE

To adjust the idle time after which RPM4's SCREEN SAVER activates.

○ PRINCIPLE

RPM4 has a SCREEN SAVER function which causes the display to dim after a front panel key is NOT pressed for a certain amount of time. The default is for the screen saver to activate after 10 idle minutes. The screen saver activation time can be adjusted by the user or screen saving can be completely eliminated.



Setting screen saver time to zero eliminates the SCREEN SAVER function so that the display permanently remains at full brightness.

○ OPERATION

To access the SCREEN SAVER function, press **[SPECIAL]**, **<5prefs>**, **<1ScrSav>**. Edit, in minutes, the idle time after which screen saver will activate to dim the screen. Set the time to zero to eliminate the SCREEN SAVER function.

3.5.5.2 <2SOUND>

○ PURPOSE

To adjust or suppress the RPM4 valid key press sound.

○ PRINCIPLE

RPM4 provides audible feedback by a brief “beep” when a valid key press is made. The tone frequency of this beep may be selected from three choices or it may be completely suppressed. Invalid key presses are indicated by a descending two tone “blorp” which cannot be suppressed.

○ OPERATION

To access the keypad sound adjustment function press **[SPECIAL]**, **<5prefs>**, **<2sound>**.

Select between **<2lo>**, **<3mid>** or **<4hi>** to adjust the valid key press tone frequency.

Select **<1none>** to suppress the valid key press tone.



The sound function only affects the valid key press tone. The invalid key press tone and other RPM4 sounds cannot be adjusted or suppressed.

3.5.5.3 <3TIME>

○ PURPOSE

To view and edit the RPM4 internal time and date settings.

○ OPERATION

To access the TIME function press **[SPECIAL]**, **<5prefs>**, **<3time>**.
The display is:

Edit: 1time 2date 08:32:11 am 20030125

Select **<1time>** to edit the time. Edit hours, then minutes, then am/pm by pressing **[ENT]** after each entry. Seconds go to zero when minutes are entered. This can be used to synchronize the time with a time standard.

Select **<2date>** to edit the date. The date must be specified in YYYYMMDD format.



The RPM4 date and time are set to United States Mountain Standard Time in the final test and inspection process at the factory. If desired, use the TIME and DATE function to set your local time and date.

3.5.5.4 <4ID>

○ PURPOSE

To view or edit the RPM4 user ID and to view the RPM4 serial number.

○ OPERATION

To access the ID function press **[SPECIAL]** and select **<5prefs>**, **<2ID>**.

Select **<1view>** to view the current ID.

Select **<2edit>** to edit the ID.

The ID has twelve characters. When the edit screen is opened, the cursor is on the first character. Numerical values can be entered directly from the keypad. In addition, the cursor control keys can be used to toggle through a list of available alphanumeric characters. Holding the key slews through the characters. Character order going up is: blank space, symbols, lower case letters, upper case letters, numbers. After selecting a character, press **[ENT]** to activate it and move to the next character field.

When a character is selected the cursor moves to the next character. To leave a blank character, press **[ENT]** with the field for that character blank. Use this for the trailing characters if the ID being entered is less than twelve characters.

After the last of the twelve characters has been entered, the **<Save ID?>** option is offered. Select **<1no>** to return to the ID edit screen. Select **<2yes>** to save the edited ID.



The ID can be set remotely from a computer which is quite a bit more convenient than entering characters from the keyboard (see Section 4.4.4, ID command). The ID is not cleared or reset by any RESET function (see Section 3.5.9).

3.5.5.5 <5LEVEL> (SECURITY)

○ PURPOSE

To set user protection levels to restrict access to certain functions and to edit the password required for changing user levels.

○ PRINCIPLE

RPM4's front panel user interface provides the means to access all RPM4 user defined data, settings and functions including calibration data. Inadvertent, uninformed or unauthorized altering or deleting of data, settings and functions could require extensive reconfiguration by the user and might cause invalid readings and behavior. For these reasons, depending upon the application in which RPM4 is being used, it may be desirable to restrict access to some functions. The user level function provides a means of restricting access to certain functions. Four different levels of security are available.

Access to changing security levels can be left open, or be protected by a password.

Security Levels

The security levels are structured to support typical operating environments as follows:

- None** This level is intended for use only by the system manager and/or calibration facility. It allows access and editing in all areas including critical metrological information.
- Low** Low security is designed to protect the specific metrological information and SYSTEM DIAGNOSTIC AND MAINTENANCE functions of the system against accidental alteration. It is intended for an advanced operator performing many different tasks. Low security is the default user level setting.
- Medium** Medium security is designed to protect specific metrological information in the system and to assure that the RPM4 is operated using consistent operational parameters.
- High** High security is designed to protect all operating parameters. It is intended to minimize operator choices, for example to perform repeated identical calibrations under consistent conditions.



RPM4 is delivered with the security level set at low to avoid inadvertent altering of critical internal settings but with access to changing security levels unrestricted. It is recommended that the low security level be maintained at all times. If there is a risk of unauthorized changing of the security level, changing authority should be password protected (see ○ OPERATION of this section).

The security levels are structured to support typical levels of operation as shown in Table 8. Specifically, the security levels prevent execution of the functions accessed by the key strokes marked by “•”:

Table 8. Security Levels

FUNCTION	LOW	MEDIUM	HIGH
[RANGE]			•
[ENT] (AutoTest)			•
[UNIT]			•
[MODE]			•
[AutoRange]		•	•
[LEAK CK]			•
[DISPLAY]		•	•
[HEAD]			•
[SDS]			•
[AutoZ] (in absolute mode)		•	•
[SETUP]			•
[SETUP], <1range>		•	•
[SETUP], <2res>		•	•
[SETUP], <4UL>		•	•
[SPECIAL]			•
[SPECIAL], <1AutoZ>		•	•
[SPECIAL], <1AutoZ>, <1on/1off>	•	•	•
[SPECIAL], <1AutoZ>, <3edit>	•	•	•
[SPECIAL], <2remote>			•
[SPECIAL], <2remote>, make changes		•	•
[SPECIAL], <3head>		•	•
[SPECIAL], <4SDS>		•	•
[SPECIAL], <5pref>, <1ScrSvr>		•	•
[SPECIAL], <5pref>, <2sound>		•	•
[SPECIAL], <5pref>, <3time>		•	•
[SPECIAL], <5pref>, <3time>, make changes	•	•	•
[SPECIAL], <5pref>, <4ID>, <2edit>	•	•	•
[SPECIAL], <6Punit>		•	•
[SPECIAL], <7internal>		•	•
[SPECIAL], <7internal>, <3RPT2x>	•	•	•
[SPECIAL], <7internal>, <5log>, clear log	•	•	•
[SPECIAL], <8cal>		•	•
[SPECIAL], <8cal>, <2edit> under any selection	•	•	•
[SPECIAL], <4reset>		•	•
[SPECIAL], <4reset>, <4cal>	•	•	•
[SPECIAL], <4reset>, <5all>	•	•	•
Remote communications disabled			•

“•” indicates the function/menu is NOT accessible.

○ OPERATION

RPM4 is delivered with no active password and access to the User Level menu is open. The user level is set to **<1Low>**. User levels can be changed freely until a password has been created.

To access the LEVEL function press **[SPECIAL]**, **<5prefs>**, **<5level>**. The display is:

```
1change user level
2edit password
```

Selecting **<1change user level>** brings up the restriction menu:

```
Restrictions: 1none
2low 3medium 4high
```

The cursor is on the current restriction level. Select a different level or **[ESC]** back to the MAIN RUN screen.

If no password is active, selecting **<2edit password>** displays the user password and allows it to be edited.

```
Password: pppppp
0 disables password
```



Once a password has been entered, the user level cannot be changed without reentering the password.

Passwords can be up to six numbers in length and cannot start with a zero. If **<0>** is entered, the password is made inactive and the user will not be required to enter a password to access the user level menu. This condition, with a security level of **<2low>**, is the factory default.

If there is an active password, the RPM4 password entry screen appears. The user must enter the user defined password or the factory secondary password to proceed further:

```
RPM4 SNnnnn-xx
Password: pppppp
```

The first field, **<nnnn>**, is the serial number of the RPM4, followed by a second field, **<xx>**, that represents the number of times that a secondary password has been used. The second field, **<xx>**, increments each time a secondary password is used. The third field, **<pppppp>** is for user entry of the normal password.



The factory secondary password is available in case the user's password has been misplaced or forgotten. It can be obtained by contacting a DHI Authorized Service Center (see Table 29). The factory secondary password is different for all RPM4's and changes each time it is used.

3.5.6 <6PUNIT>

○ PURPOSE

To customize the selection of pressure units of measure that are available in the **[UNIT]** key menu.

○ PRINCIPLE

The [UNIT] function key makes available a choice of six default pressure units (US or SI units depending on whether the RPM4 has been factory set as US or SI) (see Section 3.3.2). RPM4 also supports many commonly used units other than those included in the default set up. These units can be made available for active selection by customizing the UNIT function using [SPECIAL], <6PresU>. This allows RPM4 to offer a very wide selection of units while simplifying day to day operation. The typical user customizes the [UNIT] function key to support his/her six most commonly used units.

○ OPERATION

To customize the [UNIT] function key, from the MAIN RUN screen press [SPECIAL], <6PresU>. The display is:

1. Entry field to specify which unit position (1 to 6) of the [UNIT] function key menu is to be changed.

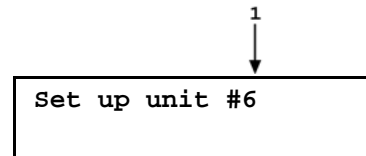

Enter the number of the unit position that you would like to change. The display becomes:

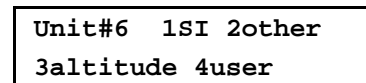

Select the desired pressure unit category (SI units include units based on SI units such as mmHg), then select the desired unit from the unit menu.

The units of measure available are listed in Table 9.

Table 9. UNIT Function - Available Units of Measure

<1SI>	<2OTHER>	<3ALTITUDE>	<4USER>
<1Pa>	<1psi>	<1feet>	
<2hPa>	<2psf>	<2meters>	
<3kPa>	<3inHg>		
<4MPa>	<4inWa>		
<5mbar>	<5kcm2>		
<6bar>	<6Torr>		
<7mmHg>	<7mTor>		
<8mmWa>			

If <4user> is selected, the user unit must be defined. The display is:

1. Entry field.

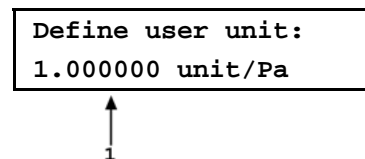

Enter the number of user units per Pascal (Pa) in the entry field. Pressing [ENT] defines the user unit and returns to the <Set up unit #n> screen.



The user defined unit label can be customized to any alphanumeric, four character label using the remote command "UDU" (see Section 4.4.4).



See Section 7.2.1 for the pressure unit conversion factors used by RPM4.

3.5.7 <7INTERNAL>

○ PURPOSE

To view, set, adjust, and maintain various aspects of RPM4's internal operation.

○ OPERATION

To access the internal selections press [**SPECIAL**], <7**internal**>. The display is:

1baro 2ReadRt 3RPT2x
4lo vnt 5log

The INTERNAL menu choices include:

- <1baro> View the real time output of the on-board barometer, if present (see Section 3.5.7.1).
- <2ReadRt> Turn ON and OFF RPM4's automated, rate of change dependent, reading integration rate feature (see Section 3.5.7.2).
- <3RPT2x> Enable and disable RPM4 parallel measurement mode in which two Q-RPT modules are used to measure in parallel and their readings are averaged (see Section 3.5.7.3).
- <4lo vnt> Operate Q-RPT module Gxxx and BGxxx low VENT valve directly (see Section 3.4.7.4).
- <5log> View the RPM4 incident log (see Section 3.5.7.5).

3.5.7.1 <1BARO>

○ PURPOSE

To view the value of atmospheric pressure as measured by the RPM4 on-board barometer.



There is no on-board barometer in RPM4s that have G100K or G200K Q-RPTs only".

○ PRINCIPLE

RPM4's that include an Axxx (absolute) and/or BGxxx (bi-directional gauge) Q-RPT are equipped with a separate, on-board barometer. The atmospheric pressure measurements made by the on-board barometer are used for dynamic compensation of atmospheric pressure when using an Axxx Q-RPT to make gauge pressure measurements (see Sections 3.3.3, ○ PRINCIPLE and 3.2.2) and for static pressure compensation when using a G15K or BG15K Q-RPT.



See Section 5.5, Figure 7 and Section 5.6, Figure 8 for a photo and schematics showing the position of the on-board barometer in RPM4.



The on-board barometer is a low accuracy sensor used only for measuring small changes in atmospheric pressure over short periods of time (see Section 3.2.2) and for line pressure compensation when using a G15K or BG15K Q-RPT. RPM4 measurement uncertainty does not depend on the measurement uncertainty of the on-board barometer.

○ OPERATION



RPM4's that have only G100K or G200K Q-RPTs (no Axxx, G15K or BG15K) are NOT equipped with an on-board barometer.

To view the current reading of the on-board barometer press **[SPECIAL]**, **<7internal>**, **<1baro>**. The display is in the active pressure unit of measure (see Section 3.3.2). The display resolution is fixed to 0.01 Pa, or its equivalent.

3.5.7.2 <2READRT>

○ PURPOSE

To turn ON and OFF RPM4's automated, rate of change dependent, reading integration rate feature.

○ PRINCIPLE

To obtain maximum resolution from RPM4 Q-RPT pressure measurements, an integration time of about 1.2 second per reading is used. In most situations, maximum precision is needed when pressures are stable so a relatively slow display update rate presents no disadvantage. However, when pressure is changing quickly, more rapid pressure updates are usually more important than obtaining maximum precision on individual readings. The RPM4 read rate function automatically adjusts pressure measurement integration time depending on the rate of change of pressure. When pressure is changing rapidly, reading rate is increased. When pressure is evolving slowly, reading rate is decreased and maximum precision is obtained.

When the automated read rate function is ON, three pressure rate of change dependent read rates are used. The result is three display update rates:

Table 10. READRT - Display Update Rates

PRESSURE RATE OF CHANGE	DISPLAY UPDATE
> 3 % of range span/s	≈ 0.2 s
> 0.5 and < 3 % of range span/s	≈ 0.6 s
< 0.5 % of range span/s	≈ 1.2 s

For situations in which maximum reading precision is desired regardless of pressure rate of change, the RPM4 automated read rate function can be turned OFF. In this case, the reading rate is always the high resolution rate of about 1.2 seconds per reading.

○ OPERATION

To turn the automated read rate function ON or OFF or check its current status, press **[SPECIAL]**, **<7internal>**, **<3ReadRt>**.

The display is:

Auto read rate: 1on 2off

The cursor is on the current selection.

Selecting **<1on>** activates the automated reading rate and returns to the MAIN RUN screen. Selecting **<2off>** turns OFF the automated reading rate and returns to the MAIN RUN screen.

The default RPM4 condition is auto read rate ON. The read rate can be set to a fixed value between 200 ms and 20000 ms using the remote command "READRATEn" (See Section 4.4.4).



Auto read rate ON/OFF is NOT Q-RPT or range specific. Turning auto read rate ON or OFF in one range turns it ON or OFF for all RPM4 ranges.

3.5.7.3 <3RPT2x>

○ PURPOSE

To enable and disable the RPM4 parallel measurement mode in which two Q-RPT modules are used to measure in parallel and their readings are averaged.

○ PRINCIPLE

RPM4s that have two Q-RPT modules of the same type (Axxx, Gxxx or BGxxx) support parallel measurement mode. In this mode, both Q-RPTs are used to measure the same pressure in parallel and their readings are averaged.

Parallel measurement mode sets up a third Q-RPT designated HL (combination of Hi and Lo). The HL RPT can be selected by the **[RANGE]** function and supports other RPM4 functions such as UNIT, MODE and DISPLAY.

When parallel measurement mode is set up, the resulting HL Q-RPT can be a third Q-RPT in addition to the Hi and Lo RPTs. It is also possible to make the HL Q-RPT the sole Q-RPT, suppressing the Hi and Lo Q-RPTs. This feature is used when an RPM4 will always be used in parallel measurement mode and the availability of the individual Hi and Lo Q-RPTs is not desired.

[SPECIAL], **<7internal>**, **<3RPT2x>** is used to set up or suppress parallel measurement mode in RPM4s that support it.



In parallel measurement mode, the maximum pressure is the maximum pressure of the Lo Q-RPT.

○ OPERATION



Parallel measurement mode is only available on RPM4s with two Q-RPTs of the same type (Axxx, Gxxx, BGxxx).

To access the parallel measurement mode enable/disable function press **[SPECIAL]**, **<7internal>**, **<3RPT2x>**.

The cursor is on the number corresponding to the current setting.

Select **<1off>** to disable parallel measurement mode. This will eliminate the HL Q-RPT.

Select **<2on>** to enable parallel measurement mode. This creates the HL parallel mode Q-RPT. The Hi and Lo Q-RPTs are also still available.

Select **<3on, w/ Hi & Lo RPT off>** to enable parallel measurement mode and disable access to the Hi and Lo Q-RPTs individually. This creates the HL parallel mode Q-RPT and makes it the sole Q-RPT available for selection.

Operation returns to normal when the disagreement between the two Q-RPTs returns to normal.



When using parallel measurement mode, the Hi and Lo Q-RPTs should be connected IN PARALLEL to the pressure to be measured (both Q-RPTs connected to the same pressure). The measured pressure indicated in parallel measurement mode is the average of the Hi and Lo Q-RPTs.

3.5.7.4 <4LO VNT>

○ PURPOSE

To cause an RPM4's Gxxx or BGxxx Q-RPT TEST(-) vent valve to stay open or closed rather than open and close automatically.



This feature is active only when the active Q-RPT is a Gxxx (gauge) or BGxxx (bi-directional gauge) Q-RPT.

○ PRINCIPLE

An RPM4 equipped with a Gxxx (gauge) or BGxxx (bi-directional gauge) Q-RPT has a **TEST(-)** vent valve in its Q-RPT module (see Figure 8, Gxxx, BGxxx, Valve C).

The **TEST(-)** vent valve is used to open the **TEST(-)** port to atmosphere which also connects the Q-RPT and the device or system under test low side to atmosphere. In normal RPM4 operation, the **TEST(-)** valve is closed to isolate the low pressure circuit from fluctuations in ambient pressure when the Q-RPT is being used to measure pressure. It is open only when SDS is closed (see Section 3.2.7).

However, it may be desirable to open the **TEST(-)** port to atmosphere while measuring pressure and/or without closing SDS. For example, this may be necessary to assure that the pressure on the low side of the Q-RPT and the system under test does not move too far away from atmosphere. **[SPECIAL], <7internal>, <4lo vnt>** allows the **TEST(-)** vent valve to be set to be permanently open, permanently closed or to operate in its default, automated condition. It also allows the current status of the valve to be viewed.

○ OPERATION



The normal, default setting for the **TEST(-)** vent valve is <1auto> in which RPM4 automatically controls the valve based on current Q-RPT module operation. Setting other than <1auto> should only be selected by advanced users.

To access the LO VNT function press **[SPECIAL], <7internal>, <4lo vent>**. If the RPM4 does not have a Gxxx (gauge) or BGxxx (bi-directional gauge) Q-RPT, the display is: **<Available with Gxxx or BGxxx Q-RPT only>**. If the RPM4 has more than one Gxxx or BGxxx Q-RPTs, the Hi or Lo Q-RPT must be selected.

The next display is:

Test(-) vent:1auto 2open 3close 4view
--

Select **<1auto>** for the **TEST(-)** vent valve operation to be controlled automatically by RPM4 based on current operation. This is the default and recommended setting.

Select **<2open>** to cause the **TEST(-)** valve to open and remain open regardless of RPM4 operation until the setting is changed. If RPM4 detects a condition

in which it determines there could be a risk of overpressure to the Q-RPT by opening the **TEST(-)** vent valve, the message **<Cannot open lo vent, DP overpressure risk>** is displayed. If this message is displayed, return to normal operation, vent the RPM4 Q-RPT module and try again.

Select **<3close>** to cause the **TEST(-)** vent valve to close and remain closed regardless of RPM4 operation until the setting is changed.

Select **<4view>** to view the current condition of the **TEST(-)** valve. The display indicates whether current valve operation is controlled by the RPM4 (**<Auto TEST(-) vent>**) or has been set manually (**<Manual TEST(-) vent>**) followed by the current valve status (**<Open>** or **<Close>**).



If the RPM4 is being used as an external device to a PPC3 pressure controller (see Section 3.5.7.4), the Lo Vent setting may be changed from the PPC3 (see the PPC3 Operation and Maintenance Manual).

3.5.7.5 <5LOG>

○ PURPOSE

To view and/or clear the RPM4 event log.

○ PRINCIPLE

RPM4 records to a log each time one of the following events occurs:

- Pmax! of an internal RPM4 Q-RPT or utility sensor is exceeded (see Section 3.4.4.1).
- A memory fault occurs.

○ OPERATION

To view the event log press **[SPECIAL], <9Log>**.

Use **[◀]** and **[▶]** to move back and forth between older and newer log entries.

Each log entry has two screens, one with the event description and one with the even time and date. Use **[▲]** and **[▼]** to toggle between the two screens. The oldest logged event appears.

After the last log has been viewed, the option to clear the log, **<1no>**, **<2yes>** is presented. Use **<2yes>** to remove all entries from the log. Use **<1no>** to continue without altering the log.

To leave the log, use **[ESC]**.

3.5.8 <8CAL>

○ PURPOSE

To calibrate the RPM4 Hi and Lo Q-RPTs and adjust the on-board barometer. These functions are considered part of RPM4 maintenance and are covered in the maintenance section of this manual (see Sections 5.2, 5.3).

○ PRINCIPLE

See Sections 5.2, 5.3.

○ OPERATION

See Sections 5.2, 5.3.

3.5.9 <9RESET>

○ PURPOSE

To reset various RPM4 settings to default or factory values.

○ PRINCIPLE

RPM4 stores its user definable settings in non-volatile memory. The reset menu allows the user to selectively or completely reset these settings to factory defaults. This clears any settings that the user has made, and should be used only to restore the RPM4 to a known state. RPM4 goes through its power up sequence after any type of reset is executed.



RPM4 reset functions will change current settings to factory defaults. These may include settings vital to RPM4 operation and affecting the calibration of the quartz reference pressure transducers (Q-RPTs). Reset functions should only be used by qualified personnel with knowledge of reset consequences. Reset functions should never be used “experimentally”.

○ OPERATION

To access the RESET menu, press **[SPECIAL]**, **<9reset>**. The display is:

1sets 2units 3ATest 4cal 5all

RESET menu choices include:

- <1set>** to reset general system operating parameters (see Section 3.5.9.1).
- <2units>** to reset unit of measure functions (see Section 3.5.9.2).
- <3ATest>** to reset AutoTest parameters and clear the AutoTest data log (see Section 3.5.9.3).
- <4cal>** to reset internal calibration coefficients and modes (see Section 3.5.9.4).
- <5all>** to reset all settings except ID and security password to factory default values (see Section 3.5.9.5).

3.5.9.1 <1SETS>

○ PURPOSE

Sets most general operating parameters back to default values. Does not affect calibration coefficients, remote interfaces or AutoRange ranges. The Reset – Sets resets are itemized in Table 11.

Table 11. Reset – Sets

RESET	RESULT	SEE SECTION
[UNIT]	Pressure unit of measure to first of the six available	3.3.2
[MODE]	Measurement mode to the native mode of the Q-RPT	3.3.3
[RANGE]	Hi Q-RPT default range	3.3.1
[HEAD]	0 cm height and Nitrogen medium	3.3
Stability Limit	0.005 % of Hi Q-RPT default range	3.4.3
Upper Limit	Hi Q-RPT default range default value	3.4.4
Resolution	0.001 % FS of Hi Q-RPT default range	3.4.2
AutoZ	AutoZ ON for all Q-RPTs and measurement modes. Z _{offset} value not affected	3.5.1
AutoZ	P _{atm,0} set to 101.325 kPa a	3.5.1, 3.2.2
Leak Check	15 second run time. Clear logged results	3.3.5
Screen Saver	10 minutes to activation	3.5.5.1
Key Sounds	Medium tone valid key press sound	3.5.5.2
Lo Vnt	Automatic	3.5.7.4
ReadRate	Automatic	3.5.7.2

3.5.9.2 <2 UNITS>

○ PURPOSE

Sets the six pressure units available under the UNIT function to the SI or US default selections depending on whether the RPM4 has been factory set for SI or US (see Section 3.3.2).

Sets the user defined unit to 1.000/Pa (see Section 3.5.6).

Sets the reference temperature for inWa unit to 20°C.

3.5.9.3 <3ATEST>

○ PURPOSE

- Resets Auto Tests to default characteristics (see Section 3.3.10).
- Clears AutoTest data log (see Section 3.4.5).

3.5.9.4 <4 CAL>

○ PURPOSE



The Reset - Cal function will reset Q-RPT, utility sensor and barometer calibration coefficients and settings and reset AutoZ values to zero. This will change the RPM4 calibration and could cause it to make out of tolerance measurements.

Clears all user values affecting the calibration of Q-RPTs and the on-board barometer. The Reset – Cal resets are itemized in Table 12.

Table 12. Reset – Cal

RESET	RESULT	SEE SECTION
All Q-RPT Calibration Coefficients	PA to zero, PM to 1	5.2.1.1, 5.2.7
Axxx Q-RPT absolute and negative gauge mode	ON	5.2.5
On-board Barometer Calibration Coefficients	PA to zero, PM to 1	5.3
Calibration Date	Set all dates to 19800101	5.2.7, 5.3
AutoZ values	Axxx Q-RPTs: All P _{offset} values to zero for absolute mode and 101325 Pa for gauge and negative gauge modes Gxxx, BGxxx Q-RPTs: All P _{offset} values to zero	3.5.1
AutoZ function	ON, all Q-RPTs, all measurement modes	3.5.1

3.5.9.5 <5 ALL>

○ PURPOSE



The reset - all function clears and deletes large amounts of user defined information including critical calibration data.

Combines all resets in one global reset command that clears the entire user section of non-volatile memory except the ID function (see Section 3.5.5.4) and the security level password (see Section 3.5.5.5) returning RPM4 to the “as delivered” condition. The Reset – All resets are itemized in Table 13.

Table 13. Reset – All

RESET	RESULT	SEE SECTION
Reset – Sets	All the resets of Reset - Sets	3.5.9.1
Reset – Units	All the resets of Reset - Units	3.5.9.2
Reset – Atest	All the resets of Reset - ATest	3.5.9.3
Reset – Cal	All the resets of Reset - Cal	3.5.9.4
Remote Interfaces	COM1, COM2 and IEEE-R88 interfaces to default settings.	3.5.2
Remote Communications	Remote command format to Classic	3.5.2.3
Level (Security)	Reset security level to low	3.5.5.5
Parallel Measurement Mode	Off	3.5.7.3
SDS	All SDS full time ON	3.5.4.2



4. REMOTE OPERATION

4.1 OVERVIEW

Most of the RPM4 front panel functions can also be executed by commands from a remote computer. The host computer can communicate to the RPM4 using the RPM4's COM1 RS232 port or it's IEEE-488 port.

Before writing test code using RPM4 remote commands, familiarize yourself with its operating principles by reading Section 3 of this manual.

4.2 INTERFACING

Sending a program message to the RPM4 places it into **remote** mode. The remote indicator to the right of the display window lights when the RPM4 is in **remote** mode. It also flickers when a program message is received. The menus usually accessed from the front panel are locked out while in remote. The **[ESC]** key returns the RPM4 to local operation unless the **<REMOTE>** program message, which locks out all keypad operation, was sent to the unit.

4.2.1 RS232 INTERFACE

4.2.1.1 COM1

The RPM4 COM1 RS232 interface is located on the back of the unit. It is a 9-pin male DB-9F connector configured as a DCE device. Data is transmitted out of the unit using pin 2, and is received on pin 3. This allows a normal pin-to-pin DB-9M to DB-9F RS232 cable to be used to connect to a DTE host.

Handshaking is not required or supported. The COM1 receive buffer is 80 bytes deep. If you overflow the buffer by sending too much data, the data will be lost. Because of this, you **must** send a single program message at a time and you **must** wait for the RPM4 to reply from the previous command before issuing another command.

Table 14. COM1 Pin Designations and Connections

RPM4 COM1 DB-9F PIN DESIGNATIONS		
PIN #	FUNCTION	DESCRIPTION
2	TxD	This pin transmits serial data from the RPM4 to the host.
3	RxD	This pin accepts serial data from the host computer.
5	Grn	This pin is the common return for the TxD and RxD signals.

IBM PC/XT DB-9F CONNECTIONS		IBM PC/XT DB-9M TO RPM4 DB9F CONNECTION	
DB-25M	DB-9F	DB-9M	DB-9F
2	3	3	3
3	2	2	2
7	5	5	5

4.2.1.2 IEEE-488

The RPM4 IEEE-488 interface is located on the back of the unit. The physical and electrical interface conforms to IEEE Std 488.1-1987 Subset E2 and IEEE Std. 488.2-1992. You should not attempt to communicate with the IEEE-488 interface while using the COM1 interface. The IEEE-488 receive buffer is 250 bytes deep. If you attempt to overflow the buffer, the RPM4 will hold off release of the NFRD handshake line until it can service and empty the receive buffer. This keeps the buffer from overflowing. It is recommended that you check for errors using the “ERR?” query after sending a group of non-query program messages. When using queries, ensure that you wait for a reply to each query to ensue proper operation and order of command execution. Replies to queries remain in the reply queue until the host gets them, so they can “stack up”, causing replies to appear out of sequence.

4.2.1.3 COM2

The RPM4 COM2 RS232 interface is located on the back of the unit. It can be used to allow the host computer to communicate with another device through the RPM4. This allows the user to use one host COM port to communicate with the RPM4 and an additional RS232 device. Refer to the “#” remote program command for details. When using the RPM4 as a reference for a PPC3, another RPM4 can be connected to the first RPM4’s COM2 port, allowing the PPC3 to communicate with both RPM4s (see Section 3.2.5).

COM2 is a 9-pin female DB-9F connector configured as a DTE device. Data is transmitted out of the RPM4 using pin 3, and is received on pin 2. This allows a normal pin-to-pin DB-9M to DB-9F RS232 cable to be used to connect to a DCE device.

Handshaking is not required or supported.

Table 15. COM2 DB-9F Pin Designations

PIN #	FUNCTION	DESCRIPTION
2	RxD	This pin transmits serial data from the RPM4 to a device.
3	TxD	This pin accepts serial data from the external device.
4	DTR	This pin is Data Terminal Ready (DTR) (held at + 5 V).
5	Grn	This pin is the common return for the TxD and RxD signals.

4.3 PROGRAMMING FORMATS

RPM4 supports two program message formats, the “**classic**”, and the “**enhanced**” formats. The user must select which format to use. Selection can be accomplished from the front panel (see Section 3.5.2.3) or remotely using the “**L2**” or “**L3**” program message (see Section 4.4.4). The “**MSGFMT**” command can also be used to select the format, but is not recommended for new designs.

The main difference between the “classic” and “enhanced” formats is that when using the IEEE-488 interface, a query operator “?” must be included in an enhanced command to yield a reply from the RPM4. When using the COM1 port in classic or enhanced mode or using the IEEE-488 port in classic mode, every command has a reply which the host must wait for before continuing. In addition, the enhanced message format supports IEEE Std 488.2 syntax, format and status reporting. The default is the classic format.

In either format, it is recommended that you start out a command sequence with the “***CLS**” command, which clears all of the communication and error queues. The basic commands are similar for both the classic and enhanced formats, but the usage, syntax, format and status reporting are different.

Many RPM4 classic and enhanced commands are common with PPC2+, PPCK+ and PPC3 Pressure/Controller Calibrators.

4.3.1 CLASSIC PROGRAM MESSAGE FORMAT

Each program message sent is also a query. You can only send one program message to the RPM4 at time. After sending any program message, you must wait for the RPM4 to reply before sending another program message. This reply will contain data, or a numeric error message if the program message was invalid. You must wait for this reply before issuing another program message to the RPM4. This insures that the RPM4 has completed the program message. Most remote program messages will return a reply within 500 ms except:

“PR?”, “PRR?”, “SR?”, “ATM?”, “RATE?”: Up to 2 seconds.

“RPT”, “ARANGE”, “AUTOZERO=RUN”: Up to 3 seconds

The syntax and format used for each program message in the classic mode is listed next to the keyword “Classic” in each program message summary in Section 4.4.4.

4.3.2 ENHANCED PROGRAM MESSAGE FORMAT

The enhanced program message format uses the IEEE Std. 488.2 format, syntax and status reporting. Errors are reported using the IEEE Std. 488.2 status reporting model. If an error is reported, the error is put into an Error Queue and the “ERR?” query program message can be used to get a text description of the most recent error. If you are using the IEEE-488 port, the service request line can be setup to be asserted if this occurs (see Section 4.5.2). In the enhanced format, there are two possible program message types for every program message. Each of these two types starts with the same basic text referred to as the program message header. The two types are COMMAND type and QUERY type commands.

4.3.2.1 USING COMMAND TYPE COMMANDS



Enhanced format commands DO NOT reply when using the IEEE-488 interface unless a “?” is included in the command. Do not expect a response from the RPM4’s IEEE-488 interface to non-query (no “?”) commands as there is none. Remote software will time-out waiting for a response from RPM4. However, in RS232 communications, there is always a response and the response MUST be read prior to issuing another command.

The COMMAND type of program message executes a process and can additionally send data to the RPM4 in the form of comma delimited arguments. This data is usually a setting of some sort that is stored in the RPM4. If data is specified, it must be preceded by at least one white space from the program message header and be within the range and format described in the program message description. The keyword “**Command:**” appears to the left of the required syntax in each program message description in Section 4.4.4.

If you are using the IEEE-488 port, the Command type does not generate a reply unless you place a query operator “?” immediately after the command. You also may send multiple program messages at once by separating each program message with a semicolon. The commands are queued and executed in as received order after the entire message stream has been received, so care in determining order of execution is needed.

If you are using the RS232 port COM1, the Command type will always generate a reply so you **must** wait for a reply before issuing another program message. Because of this, you can only send one Command program message at a time while using the COM1 port.

Examples:**• IEEE-488 enhanced mode command series using query operator:**

“*CLS?” (Clear the error queue. Wait for reply)
“UNIT? KPA” (Generates a reply. User must wait for reply before continuing)
“MMODE? A” (Generates a reply. User must wait for reply before continuing)
“PR?” (Generates a reply. User must wait for reply before continuing)

• IEEE-488 enhanced mode commands without query operator:

“*CLS” (Clear the error queue. No reply)
“UNIT KPA” (No reply)
“MMODE A” (No reply)
“ERR?” (Wait for reply. User should use “ERR?” query following a series of non query commands to check for errors that may have occurred)

• IEEE-488 enhanced mode multiple commands without query operator:

“*CLS” (Clear the error queue. No reply)
“UNIT KPA;MMODE A” (Two command at once. No reply)
“ERR?” (Wait for reply. User should use “ERR?” query following a series of non query commands to check for errors that may have occurred)

• COM1 enhanced mode command:

“*CLS” or “*CLS?” (Clear the error queue. Wait for reply)
“UNIT KPA” or “UNIT? KPA” (Generates a reply. User must wait for reply before continuing)
“MMODE A” or “MMODE? A” (Generates a reply. User must wait for reply before continuing)
“PR” or “PR?” (Generates a reply. User must wait for reply before continuing)

4.3.2.2 USING QUERY TYPE COMMANDS

The QUERY type of program message just requests data from the RPM4. Placing the query operator “?” immediately after the command creates a query. You **must** wait for a reply with a query. If you send any type of program message to the RPM4 after a query before receiving a reply, the program message is discarded and an error is generated. Errors are reported using the IEEE Std. 488.2 status reporting model. A Query program message always ends with a question mark. Most queries return a reply within 200 ms except:

“PR?”, “PRR?”, “SR?”, “ATM?”, “RATE?”: Up to 2 seconds.

“RPT”, “ARANGE”, “AUTOZERO RUN”: Up to 3 seconds

The syntax for using a QUERY program message is listed next to the keyword “Query:” in each program message summary in Section 4.4.4. Please note that queries in enhanced mode via the IEEE-488 port that results in an error will not result in a reply. You must check the error queue (use the “ERR” query) to see if an error has occurred.

4.4 COMMANDS

4.4.1 PROGRAMMING MESSAGES

Some commands accept an optional suffix. This suffix can be used to specify the explicit Q-RPT to address. In most cases, each Q-RPT in the RPM4 operates as an independent measurement device. If the suffix is not specified, then the “Active” Q-RPT is assumed. The “RANGE” or “ARANGE” command can be used to select the “Active” Q-RPT. There are some limitations to use of the suffix when the RPM4 is in differential mode (see Section 3.3.3.1) or the “HL” Q-RPT is active (see Section 3.2.4). See the program message descriptions for suffix use with a specific command.

Table 16. Program Message List

COMMAND 'n' indicates an optional suffix	DESCRIPTION
#	Send a command string out of the RPM4 COM2 port.
ABORT	Stop pending operations
ARANGE <i>n</i>	Read or set a new AutoRange to use.
ATM	Read the current atmospheric pressure (on-board barometer).
AUTOZERON	Read or set the status of the AutoZ automatic zeroing function.
AUTOZERON=RUN	Run AutoZero.
CALAMB	Read or set the on-board barometer calibration
COM1	Read or set the configuration of the COM1 port.
COM2	Read or set the configuration of the COM2 port.
CONT <i>n</i>	Enable continuous measurements
DATE	Read or set the current date.
ERR	Read the last error message.
GPIB	Read or set the GPIB interface address.
HEAD	Read or set the fluid head settings.
ID	Read or set the RPM4 alphanumeric asset ID tag.
L2	Selects “classic” program message format
L3	Selects “enhanced” program message format
LL <i>n</i>	Read or set the lower limit for the current range (negative gauge and differential modes only).
LOCAL	Return control to the RPM4 front panel.
MEM	Read the power-up memory test status.
MMODE <i>n</i>	Read or change the active measurement mode.
MSGFMT	Read or set the type of program message format to use.
NVENT <i>n</i>	Read or set the status of low vent valve (Gxxx or BGxxx Q-RPT only)
PCAL <i>n</i>	Read or set the user Lo Q-RPT calibration information.
PCAL:XX	Read or set the user Lo Q-RPT calibration information (old command).
PR <i>n</i>	Read the next RPM4 pressure.
PRR <i>n</i>	Read the next RPM4 pressure, rate, and ATM.
QPRR <i>n</i>	Read the last RPM4 pressure, rate and ATM.
RANGE	Select a Q-RPT to be “active” in it’s default full scale range
RATE <i>n</i>	Read the next available rate of change of pressure.
READRATE <i>n</i>	Read or set the Q-RPT measurement read rate and mode
READYCK <i>n</i>	Read or set a flag that is cleared by a <i>Not Ready</i> condition.
REMOTE	Enable remote local lockout operation.
RES <i>n</i>	Read or set the pressure display resolution for the current Q-RPT and range.
RESET	Reset the RPM4 to default user parameters.
RPT <i>n</i>	Read the available Q-RPT data.
SCRSAV	Read or set the front panel screen saver period.
SDS <i>n</i>	Read or set the SDS state for a specific Q-RPT
SDSACT	Read or set the active Q-RPT SDS state
SDSAUTON	Read or set the SDS mode for a specific Q-RPT
SN	Read the serial number of the RPM4.
SR <i>n</i>	Read the next available pressure status (<i>Ready/Not Ready</i>).
SS <i>n</i>	Read or set the stability required for a <i>Ready</i> condition.
SS% <i>n</i>	Read or set the stability required for a <i>Ready</i> condition (% span/ s).
TIME	Read or set the current time of day.
UCOEF <i>n</i>	Convert a pressure in Pascal to pressure in the current units.
UDU	Read or set the user defined pressure unit.

COMMAND 'n' indicates an optional suffix	DESCRIPTION
ULn	Read or set the upper limit for the current range.
UNITn	Read or set the pressure unit of measure for the current range.
VER	Read the RPM4 software version.
ZOFFSETn	Read or set the AutoZero Z_{offset} for the specified Q-RPT.
ZOFFSET:XX	Read or set the AutoZ Z_{offset} for the specified Q-RPT (old command).

4.4.2 ERROR MESSAGES

Table 17. Error #s and Descriptions

REPLY	DESCRIPTION
ERR# 0	"OK"
ERR# 2	"Text argument is too long"
ERR# 3	"Arguments cannot be 0"
ERR# 4	"External device not detected"
ERR# 5	Not used
ERR# 6	"Numeric argument missing or out of range"
ERR# 7	"Missing or improper command argument(s)"
ERR# 8	"External device time-out error"
ERR# 9	"Unknown command"
ERR# 10	"Missing or invalid command suffix"
ERR# 11	"Command missing argument"
ERR# 12	"System overpressured" or "overpressure may result"
ERR# 13	"Text queue overflow"
ERR# 14	"User unit not defined"
ERR# 17	Not used
ERR# 18	"Command not yet available"
ERR# 19	"Not available with absolute units"
ERR# 20	"Not available with gauge device"
ERR# 21	Not used
ERR# 22	"Pressure is not stable"
ERR# 23	"Option not available or installed"
ERR# 25	Not used
ERR# 26	"COM port failed to initialize"
ERR# 27	"Internal device failure"
ERR# 28	"Device failure"
ERR# 29	"Device not available"
ERR# 30	"Must be on range HI"
ERR# 31	"Exceeds upper or lower limit"
ERR# 32	"Not stable enough"
ERR# 37	"Data table is full"
ERR# 38	"Selected range is not available"
ERR# 39	"Data verify error"
ERR# 45	"Argument not allowed"
ERR #46	"Argument cannot be negative"
ERR #52	"Command obsolete"
ERR# 53	"Not Available"

4.4.3 PROGRAM MESSAGE DESCRIPTION OVERVIEW

Each program message description is separated into the following sections:

Purpose	A brief description of the programs message's function.
Command	This is the Enhanced program message syntax to send data to the RPM4 or to execute an RPM4 function. The RPM4 must be set to use the enhanced format (see Section 3.5.2.3) to use the syntax and style shown. It may be sent alone, or followed by at least one white space and additional argument(s) to show that arguments can be passed. If there are multiple arguments, then commas must separate them. If you are using the IEEE-488 port, multiple command type program messages can be sent in one message if you separate them with a semicolon. There will be no reply from the RPM4 using the IEEE-488 port unless the command is immediately followed by the query operator "?". If you are using the COM1 port, the PPC1 will reply and you must wait for this reply. If this field is not listed in the program message description, then the Command type is not supported when using the Enhanced format.
Query	This is the Enhanced program message syntax to request data from the RPM4. The RPM4 must be set to use the enhanced format (see Section 3.5.2.3). The RPM4 will always reply to a query. You must wait for this reply before issuing another program message. If this field (Query) is not listed in the program message description, then the Query type for the program message is not supported when using the Enhanced format.
Classic	This is the Classic program message syntax to send data to the RPM4, to execute an RPM4 function, or to query for data. The RPM4 must be set to use the classic format (see Section 3.5.2.3). The command may be followed by a '(=)' and additional argument characters to show that argument(s) can be passed. If there are multiple arguments, then commas must separate them. The RPM4 will always reply to a Classic program message. You must wait for this reply before issuing another program message. If this field is not listed in the program message description, then it is not supported when using the classic format.
Suffix	Some commands support an optional suffix. This suffix is used to specify a Q-RPT to which the command applies, since many settings are Q-RPT specific: Suffix of '1' for Hi Q-RPT access Suffix of '2' for Lo Q-RPT access Suffix of '3' for HL Q-RPT access. If an optional suffix is allowed but not given, then the "Active Q-RPT" will be addressed. The "Active Q-RPT" is the Q-RPT that is currently displayed on the top line of the front panel of the RPM4, and is identified by the text label in the upper right of the pressure display screen. The last Q-RPT ranged or selected using the "RANGE" or "ARANGE" commands is the "Active" Q-RPT. The "ARANGE", "RANGE" or "RPT" command query can be used to determine which Q-RPT is currently active. With the Hi Q-RPT In differential mode of operation, there are some limitations on access to the Lo Q-RPT, and with the HL Q-RPT there are limitations on access to both the Hi and the Lo Q-RPTs independently.
Arguments	If the program message can be used to set data inside the RPM4, then this section describes the arguments and their limits.
Default	If the program message can be used to set data inside the RPM4, then this line shows (using the enhanced format) the default setting from the factory.
Remarks	This field has the details and remarks about the command.
Example	Examples are given for the enhanced and classic methods. Enhanced: An example of the use of an enhanced format program message to be sent to the RPM4 is shown. The message sent to the RPM4 appears after the "Cmd sent:" label. If only a Query type exists, the "Query sent:" label is shown instead. Directly under this label, "Query reply" shows a typical reply to a query type. "Reply:" shows that a query format does not exist. It may have a short description next to it. Classic: An example of the use of a classic program message to be sent to the RPM4 is shown. The command sent to the RPM4 appears after the "Cmd sent:" label. The "Reply" label shows a typical reply to the "Sent" example. It may have a short description next to it.
Errors	If the program message can report an argument error, the types of errors are listed. If using the classic format or the COM1 port, the error message is replied after receiving the program message. If using the enhanced format via the IEEE-488 port, the error condition is handled by the status reporting model which stores the errors in an Error Queue and can be programmed to assert the IEEE-488 SRQ line to signal an error has occurred. In either case, the "ERR" or "ERR?" program message can be used to retrieve a text description of the error.
See Also	Indicates related commands ("----") and refers to manual sections giving detail on RPM4 operation corresponding to the program message.

4.4.4 PROGRAM MESSAGE DESCRIPTIONS

#	
Purpose	To allow the host PC to communicate with a device connected to the RPM4 COM2 port.
Classic	"#xx"
Arguments	xx: The string to send out of the RPM4 COM2 port. It must be less than 40 characters long.
Remarks	<p>The RPM4 COM2 port can be used to communicate to another RS232 device (such as another RPM4). This allows the user to use a single COM port or IEEE-488 port on the host computer to communicate with the RPM4 and another RS232 device. A carriage return and a line feed (<CR><LF>) are added to the string.</p> <p>After this program message is issued, the RPM4 will reply back every string received by the RPM4 COM2 port that is terminated with a carriage return. Line feeds are discarded. This will discontinue when the next query is sent to the RPM4.</p> <p>There is no other reply from this program message. Prior to using this program message, you must ensure that the RPM4 COM2 port is correctly set up to communicate with the device on COM2. Refer to the "COM2=" program message.</p>
Example (classic)	Sent: "#VER" Reply: "DH INSTRUMENTS, INC RPM4 us A1000/A0015 Ver2.00 " This example assumes that a second RPM4's COM1 port is connected to the RPM4 COM2 port. This example gets the version of the second RPM4.
See Also	"COM2" 3.5.2

ABORT	
Purpose	Cancels any pending data requests by the "PR", "PRR" "RATE", "SR" or "CONT" commands.
Command Classic	"ABORT" "ABORT"
Remarks	This program message is usually used to ensure the RPM4 is in an idle condition.
Example (enhanced)	Cmd sent: "ABORT" Reply: "ABORT" (no reply if IEEE-488)
Example (classic)	Sent: "ABORT" Reply: "ABORT"
See Also	"PR", "PRR" "RATE", "SR" or "CONT" 3.2.1

ARRANGEn	
Purpose	Read or set a new AutoRange range to use.
Command	"ARRANGE n Range, unit, mode (<i>RptLabel</i>)" (set to user defined range) "ARRANGE Q-RPTLabel" (set to Q-RPT default range)
Query	"ARRANGE?"
Classic	"ARRANGE= Range, units, mode (<i>RptLabel</i>)" (set to user defined range) "ARRANGE= Q-RPTLabel" (set to Q-RPT default range)
Query	"ARRANGE"
Optional Suffix	" n " A suffix may be used instead of " <i>RptLabel</i> " '1' Specify the Hi Q-RPT if the Hi and Lo Q-RPTs are NOT OFF Specify the HL Q-RPT if the Hi and Lo Q-RPTs are OFF '2' Specify the Lo Q-RPT '3' Specify the HL Q-RPT
Arguments	<p><i>Range</i>: The AutoRange maximum pressure. Cannot be negative. <i>Unit</i>: The unit of measure of the <i>Range</i> argument. <i>Mode</i>: The measurement mode of the <i>Range</i> argument: "A" for absolute "G" for gauge "N" for negative gauge</p> <hr/> <p> Measured pressure values are returned with "g" to identify measurement mode for both gauge and negative gauge measurement modes.</p> <hr/> <p><i>RptLabel</i>: One of the Q-RPTs that is available. (optional) "IH": Hi Q-RPT if the Hi and Lo Q-RPTs are NOT OFF. HL Q-RPT if the Hi and Lo Q-RPTs are OFF. "IL": Lo Q-RPT "HL": HL Q-RPT.</p>
Remarks	<p>The ARRANGE command is used to define an RPM4 range by specifying a desired unit of measure, measurement mode and maximum pressure, and have the RPM4 pick the best available Q-RPT and make adjustments to optimize operation in that range.</p> <p>The optional suffix or the "<i>RptLabel</i>" argument can be used to specify which Q-RPT you wish to use for the AutoRange range instead of allowing the RPM4 to pick the best Q-RPT. By using this option you can override the internal logic that picks the most suitable Q-RPT. This Q-RPT specified must be valid for the maximum pressure and measurement mode specified.</p> <p>The reply indicates the current range data, including the <i>Q-RPTLabel</i> used for the range.</p> <p>If "inWa" is specified for the unit, the temperature reference can be given after the unit text ("inWa4", "inWa20" or "inWa60" corresponding to inWa at 4 °C, 20 °C or 60 °F). If no number is given, a default of 20 °C is assumed. There is no indication of the temperature reference in the reply.</p> <p>If you just specify the <i>Q-RPTLabel</i> without any other arguments, the Q-RPT specified will become active in it's last range and settings. The previously set unit and measurement mode for the Q-RPT specified will become active.</p>
Example (enhanced)	Cmd sent: "ARRANGE?" (read the current range in the current units) Query reply: "100.00, psi, A, IH"
Example (classic)	Cmd sent: "ARRANGE" (read the current range in the current units) Query reply: "100.00, psi, A, IH"
Example (enhanced)	Cmd sent: "ARRANGE? 250, inWa4, G (range of 250 inWa @ 4 °C in gauge mode) Query reply: "250.00 inWa, G, IH" (Lo Q-RPT is used)
Example (classic)	Cmd sent: "ARRANGE=500, kPa, G (range of 500 kPa in gauge mode) Query reply: "500.00 kPa, G, IL" (Lo Q-RPT is used)
Example (enhanced)	Cmd sent: "ARRANGE2 50, psi, A (range of 50 psi in absolute mode on the Lo Q-RPT) Query reply: "50.000 psi, A, IL" (No reply if GPIB-488)
Example (enhanced)	Cmd sent: "ARRANGE IH (Hi Q-RPT's prev range made active) "500.000 kPa, A, IH" (No reply if GPIB-488) Query reply:
Errors	ERR# 6: " <i>Range</i> " maximum pressure exceeds available Q-RPTs or is negative. ERR#10: RPT specified by the optional suffix is not valid for the current operating conditions ERR# 19: Cannot Range to '0' with absolute units. ERR# 20: Cannot Range to '0' with gauge units. ERR# 29: Correct type of Q-RPT for the selected " <i>Mode</i> " is not available. ERR# 53: RPT specified is not available.
See Also	"RPT", "RANGE", "MMODE", "UNIT" 3.3.4, .3.2.4, 3.3.3, 3.3.2

ATM	
Purpose	Reads the next measured pressure from RPM4's on-board barometer (if present).
Query	"ATM?"
Classic	"ATM"
Remarks	The atmospheric pressure as measured by the RPM4 on-board barometer is returned in the current pressure units of the active Q-RPT (always absolute). This measurement is followed by the units text. Not all RPM4s are equipped with an on-board barometer.
Example (enhanced)	Query sent: "ATM?" Query reply: "97.12348 kPa a"
Example (classic)	Sent: "ATM" Reply: "97.12384 kPa a"
Errors	ERR# 23: RPM4 is not equipped with a barometer.
See Also	3.5.7.1

AUTOZEROn	
Purpose	Read or set the status of the AutoZ function.
Command	"AUTOZEROn state"
Query	"AUTOZEROn?"
Classic	"AUTOZEROn= state" "AUTOZEROn"
Default	"AUTOZERO1"
Optional Suffix	"n" The active Q-RPT is assumed if no suffix is given. '1' Specify the Hi Q-RPT if the Hi and Lo Q-RPTs are NOT OFF Specify the HL Q-RPT if the Hi and Lo Q-RPTs are OFF '2' Specify the Lo Q-RPT '3' Specify the HL Q-RPT if the HL Q-RPT is active
Arguments	'state': '0' Autozero OFF '1' Autozero ON
Remarks	The RPM4 AutoZ function can be turned ON and OFF. There is a separate AutoZ flag for the gauge, absolute, and differential measurement modes for each Q-RPT. This command sets the AutoZ status for the current mode of the specified or the active Q-RPT only. To set the state of AutoZ for a measurement mode, you must be in that mode.
Example (enhanced)	Cmd sent: "AUTOZERO 0" Query reply: "0" (No reply if GPIB-488)
Example (classic)	Sent: "AUTOZERO=0" Query reply: "AUTOZERO=0"
Errors	ERR# 7: The argument was other than '0' or '1'. ERR# 10: The suffix is invalid.
See Also	"ZOFFSET", "MMODE" 3.5.1

AUTOZEROn=RUN	
Purpose	Run the AutoZero routine.
Command	"AUTOZEROn RUN (,Pref)"
Query	"AUTOZEROn? RUN (,Pref)"
Classic	"AUTOZEROn= RUN (,Pref)"
Optional Suffix	"n" The active Q-RPT is assumed if no suffix is given. '1' Specify the Hi Q-RPT if the Hi and Lo Q-RPTs are NOT OFF Specify the HL Q-RPT if the Hi and Lo Q-RPTs are OFF '2' Specify the Lo Q-RPT '3' Specify the HL Q-RPT if the HL Q-RPT is active
Arguments	'Pref': The AutoZ reference pressure in Pa. Optional when the RPM4 is not in absolute measurement mode, as the reference is usually "0".
Remarks	The RPM4 AutoZ function can be remotely run with this command only if AutoZero is ON. You should ensure that the pressure is stable for valid determination of Z_{offset} . If in differential mode, the previous 5 measurements of the Q-RPTs are averaged for Z_{offset} calculation so you should ensure that the RPM4 has been stable for at least 5 measurement cycles before running a remote AutoZ in differential mode.
Example (enhanced)	Cmd sent: "AUTOZERO RUN" Query reply: "OK" (No reply if GPIB-488)
Example (enhanced)	Cmd sent: "AUTOZERO? RUN, 97283" (abs AutoZero to 97283 Paa) Query reply: "OK"
Example (classic)	Sent: "AUTOZERO=RUN" Query reply: "OK"
Errors	ERR# 6: An argument was not given for the AutoZ reference in absolute mode. ERR# 10: Invalid suffix ERR# 53 AutoZero is currently OFF.
See Also	"ZOFFSET", "MMODE", "AUTOZERO" 3.5.1

CALAMB	
Purpose	Read or set the on-board barometer calibration.
Command	"CALAMB <i>adder, mult, CalDate</i> "
Query	"CALAMB?"
Classic	"CALAMB= <i>adder, mult, CalDate</i> " "CALAMB"
Defaults	"CALAMB = 0.0, 1.0, 19800101"
Arguments	<i>Adder</i> : The Barometer calibration adder (PA), in Pascal. <i>Mult</i> : The Barometer calibration multiplier (PM) from 0.1 to 100. <i>CalDate</i> : The date of the calibration in the format "YYYYMMDD"
Remarks	The barometer calibration information can be accessed with this program message. Using this program message overwrites the current calibration coefficients, so caution must be used. Changes made take effect immediately.
Example (enhanced)	Cmd sent: "CALAMB? 2.1, 1.000021, 20011201" Query reply: " 2.10, 1.000021, 20011201"
Example (classic)	Sent: "CALAMB=2.1, 1.000021, 20011201" Reply: " 2.10, 1.000021, 20011201"
Errors	ERR# 6: One of the arguments is out of range.
See Also	3.5.7.1, 5.3

COM1	
Purpose	Read or set the RS232 settings for the COM1 port.
Command	"COM1 <i>baud, parity, data, stop</i> "
Query	"COM1?"
Classic	"COM1= <i>baud, parity, data, stop</i> " "COM1"
Arguments	<i>Baud</i> : The baud rate. This may be '300', '600', '1200', '2400', '4800', '9600' or '19200'. <i>Parity</i> : The data parity. This may be 'O' for odd, 'E' for even, or 'N' for none. <i>Data</i> : The number of data bits. This may be '7' or '8'. <i>Stop</i> : The number of stop bits. This may be '1' or '2'.
Defaults	"COM1 2400,E,7,1"
Remarks	The COM1 port is used to communicate to the RPM4. When the COM1 port configuration of the RPM4 is changed, the program message reply (COM1 use only) is sent at the old COM1 settings, but all subsequent communications are accomplished at the new COM1 settings. A 250ms or longer delay after receiving the reply to this command will ensure that the RPM4 has changed the COM port settings and is ready for communications at the new settings.
Example (enhanced)	Cmd sent: "COM1 9600,N,8,1" Query reply: "9600,N,8,1" (No reply if GPIB-488)
Example (enhanced)	Cmd sent: "COM1? 9600,N,8,1" Query reply: "9600,N,8,1"
Example (classic)	Sent: "COM1=9600,N,8,1" Reply: "9600,N,8,1"
Errors	ERR# 7: Missing or improper program message argument(s).
See Also	"COM2" 3.5.2.1

COM2	
Purpose	Read or set the RS232 settings for the COM2 port.
Command	"COM2 <i>baud,parity,data,stop</i> "
Query	"COM2?"
Classic	"COM2= <i>baud,parity,data,stop</i> " "COM2"
Arguments	<i>baud</i> : The baud rate. This may be '300', '600', '1200', '2400', '4800', '9600' or '19200'. <i>parity</i> : The data parity. This may be 'O' for odd, 'E' for even, or 'N' for none. <i>Data</i> : The number of data bits. This may be '7' or '8'. <i>stop</i> : The number of stop bits. This may be '1' or '2'.
Defaults	"COM2 2400,E,7,1"
Remarks	COM2 is generally used to allow the host computer to communicate through the RPM4 to an additional device connected to COM2. This can be useful if the host computer does not have 2 serial ports available.
Example (enhanced)	Cmd sent: "COM2 9600,N,8,1" Query reply: "9600,N,8,1" (No reply if GPIB-488)
Example (enhanced)	Cmd sent: "COM2? 9600,N,8,1" Query reply: "9600,N,8,1"
Example (classic)	Sent: "COM2=9600,N,8,1" Reply: "9600,N,8,1"
Errors	ERR# 7: Missing or improper program message argument(s).
See Also	"COM1" 3.5.2.1

CONTn	
Purpose	Have the RPM4 reply continuously as each new measurement becomes available.
Query	"CONT n ?"
Classic	"CONT n "
Optional Suffix	" n " The active Q-RPT is assumed if no suffix is given. '1' Specify the Hi Q-RPT if the Hi and Lo Q-RPTs are NOT OFF Specify the HL Q-RPT if the Hi and Lo Q-RPTs are OFF '2' Specify the Lo Q-RPT '3' Specify the HL Q-RPT if the HL Q-RPT is active
Remarks	This command is somewhat different than most as it enables the RPM4 to continuously output the selected Q-RPT's measurement without further queries. This continues until the next query is received by the RPM4, or if the ABORT" or ""CLS" command is received. The frequency of the measurements is determined by the readrate of the Q-RPT. The data returned includes the pressure of the specified or active Q-RPT, current unit of measure and measurement mode.
Example (enhanced)	Query sent: "CONT1?" Query reply: "1936.72 kPa a" (repeats every measurement cycle)
Example (classic)	Query sent: "CONT" Reply: "1936.72 kPa a" (repeats every measurement cycle)
See Also	"PR", "READRATE"

DATE	
Purpose	Read or set the RPM4 date.
Command	"DATE <i>date</i> "
Query	"DATE?"
Classic	"DATE= <i>date</i> " "DATE"
Arguments	<i>date</i> : The date in the numerical only format "YYYYMMDD"
Remarks	The RPM4 has an internal real time calendar clock. The span of acceptable dates ranges from 19800101 to 20791231. The reply is always in the YYYYMMDD format.
Example (enhanced)	Cmd sent: "DATE 20030115" Query reply: "20030105" (No reply if GPIB-488)
Example (enhanced)	Cmd sent: "DATE? 20030105" Query reply: "20030105"
Example (classic)	Sent: "DATE=20021201" Reply: "20021201"
Errors	ERR# 6: Missing or improper program message argument(s).
See Also	"TIME" 3.5.5.3

ERR	
Purpose	Read the new available error message from the Error Queue.
Query	"ERR?"
Classic	"ERR"
Remarks	This program message obtains additional details about an error that has occurred. If the user receives an "ERR# nn " reply, or the enhanced mode is enabled using the IEEE-488 interface and an error has been detected, the error is put into a FIFO Error Queue. The "ERR" program message pulls and replies the oldest error message available. In "classic" mode only the most recent error can reside in the queue. "OK" is replied if there are no error messages left. If an error occurs in enhanced mode using the IEEE-488 interface, no reply is generated even if the command was a query.
Example (enhanced):	Query sent: "ERR?" Query reply: "Numeric argument missing or out of range"
Example (classic)	Sent: "ERR" Reply: "Numeric argument missing or out of range"
See Also	4.4.2

GPIB	
<i>Purpose</i>	Read or set the GPIB interface address.
<i>Command</i>	"GPIB <i>addr</i> "
<i>Query</i>	"GPIB?"
<i>Classic</i>	"GPIB= <i>addr</i> " "GPIB"
<i>Defaults</i>	"GPIB 10"
<i>Arguments</i>	<i>Addr:</i> The address of the IEEE-488 (GPIB) interface (1 to 30)
<i>Remarks</i>	The GPIB address is changed following the reply of this command. Each device on a GPIB interface bus requires a unique address.
<i>Example (enhanced)</i>	Cmd sent: "GPIB 21" Query reply: "21" (No reply if GPIB-488)
<i>Example (enhanced)</i>	Cmd sent: "GPIB? 21" Query reply: "21"
<i>Example (classic)</i>	Sent: "GPIB=21" Reply: "21"
<i>Errors</i>	ERR# 6: The argument is not within given limits.
<i>See Also:</i>	3.5.2.2

HEAD	
<i>Purpose</i>	Read or set the fluid head settings.
<i>Command</i>	"HEAD <i>height, units, fluid</i> "
<i>Query</i>	"HEAD?"
<i>Classic</i>	"HEAD= <i>height, units, fluid</i> " "HEAD"
<i>Defaults</i>	"HEAD 0, cm, N2"
<i>Arguments</i>	<i>height:</i> The height of the test in relation to the RPM4. The value is positive if the test is above the RPM4, or negative if below the RPM4. The value can be between -9999 and 9999. Setting the value to '0' disables the head correction. <i>units:</i> The height units. This must be "in" or "cm". <i>gas:</i> The fluid type. This must be "N2", "Air", "He", "Oil", "H2O", or "User".
<i>Remarks</i>	The RPM4 can make a fluid head correction to allow it to display the pressure at a level other than the reference level of the RPM4.
<i>Example (enhanced)</i>	Cmd sent: "HEAD? 10,in,N2" Query reply: "10, in, N2"
<i>Example (classic)</i>	Sent: "HEAD=10,in,N2" Reply: "10, in, N2"
<i>Errors</i>	ERR# 2: The fluid text is too long ERR# 6: The height is not within given limits or the unit is invalid. ERR #7: The fluid text is invalid
<i>See Also:</i>	3.3.7, 3.5.3

ID	
<i>Purpose</i>	Read or set the user defined instrument identification label.
<i>Command</i>	"ID <i>string</i> "
<i>Query</i>	"ID"
<i>Classic</i>	"ID= <i>string</i> " "ID"
<i>Arguments</i>	<i>String:</i> An alphanumeric string up to 12 characters long.
<i>Remarks</i>	The user defined ID label can be used to allow the user to "tag" the RPM4 with a unique identifier. This ID is stored in non-volatile memory and cannot be erased by a power failure, system fault or reset. The ID should not be changed frequently, as the non-volatile memory may fail after 100,000 write operations.
<i>Example (enhanced)</i>	Cmd sent: "ID RPM4 #A01" Query reply: "RPM4 #A01" (No reply if GPIB-488)
<i>Example (enhanced)</i>	Cmd sent: "ID? RPM4 #A01" Query reply: "RPM4 #A01"
<i>Example (classic)</i>	Sent: "ID=RPM4 #A01" Reply: "RPM4 #A01"
<i>Errors</i>	ERR# 2 Text argument is too long (more than 12 characters)
<i>See Also</i>	3.5.5.4

L2 / L3	
Purpose	Read or set the type of program command format to use (classic or enhanced).
Command	"L2" enables "classic" mode "L3" enables "enhanced" mode
Defaults	"L2" (Classic mode)
Remarks	The user can select the type of remote command format using these simplified commands. There is no query format. This format must agree with the format sent to the RPM4. This command is a replacement for the "MSGFMT" command.
Example (enhanced)	Cmd sent: "L3" Query reply: "L3" (No reply if IEEE-488)
Example (classic)	Sent: "L2" Reply: "L2"
See Also	"MSGFMT" 4.3, 3.5.2.3

LLn	
Purpose	Read or set the lower pressure limit for the active range and measurement mode (negative gauge or differential measurement mode only).
Command	"LLn <i>limit</i> "
Classic	"LLn= <i>limit</i> "
Optional Suffix	"n" The active Q-RPT is assumed if no suffix is given. '1' Specify the Hi Q-RPT if the Hi and Lo Q-RPTs are NOT OFF and the HL Q-RPT is not active. Specify the HL Q-RPT if the Hi and Lo Q-RPTs are OFF '2' Specify the Lo Q-RPT if the HL Q-RPT is not active and measurement mode is not differential. '3' Specify the HL Q-RPT if the HL Q-RPT is active.
Arguments	" <i>limit</i> ": The lower pressure limit for the current pressure range in the specified Q-RPT's current unit of measure unit and measurement mode. Value is always a negative value of gauge pressure.
Remarks	Negative gauge and differential modes in RPM4 have a lower limit. If the pressure is less than the lower limit, the pressure display flashes. This feature should always be used to prevent accidental over (under) pressure of a device under test.
Example (enhanced)	Cmd sent: "LL -4" Reply: "-4 kPa g" (no reply if IEEE-488)
Example (enhanced)	Cmd sent: "LL? -4" Reply: "-4 kPa g"
Example (classic)	Sent: "LL=-4" Reply: "-4 kPa g"
Errors	ERR# 6: The <i>limit</i> argument is invalid. ERR# 10: The suffix is invalid ERR# 23: The mode must be negative gauge to specify a lower limit.
See Also	"UL", "MMODE" 3.4.4, 3.3.3

LOCAL	
Purpose	Returns control to the RPM4 front panel.
Command	"LOCAL"
Classic	"LOCAL"
Remark	The REMOTE program message can lock the front panel out completely. The user can return to local operation by sending the LOCAL program message, sending the IEEE-488 'GTL' command (if in enhanced format), or by cycling RPM4 power.
Example (enhanced)	Cmd sent: "LOCAL" Reply: "LOCAL" (no reply if IEEE-488)
Example (enhanced)	Cmd sent: "LOCAL?" Reply: "LOCAL"
Example (classic)	Sent: "LOCAL" Reply: "LOCAL"
See Also	"REMOTE"

MEM	
Purpose	Read the status from the power-up memory test.
Query	"MEM?"
Classic	"MEM"
Remarks	The RPM4 system memory stores the user settings (units, resolution) and retains them when the unit is OFF. On power-up, this memory is checked. If this memory is corrupted, all user settings are reset to default, and the MEM status is set to reflect this.
Example (enhanced)	Query sent: "MEM?" Reply: "0" RPM4 data corrupted and was set to factory defaults. "1" The memory was found to be OK on power-up.
Example (classic)	Sent: "MEM" Reply: "MEM=0" RPM4 data corrupted and was set to factory defaults. "MEM=1" The memory was found to be OK on power-up.
See Also	3.5.9, 3.5.7.5

MMODEn	
Purpose	Read or change the active measurement mode.
Command	"MMODE n mode"
Query	"MMODE n ?"
Classic	"MMODE n =mode" "MMODE n "
Optional Suffix	" n " The active Q-RPT is assumed if no suffix is given. '1' Specify the Hi Q-RPT if the Hi and Lo Q-RPTs are NOT OFF and the HL Q-RPT is not active. Specify the HL Q-RPT if the Hi and Lo Q-RPTs are OFF '2' Specify the Lo Q-RPT if the HL Q-RPT is not active and measurement mode is not differential. '3' Specify the HL Q-RPT if the HL Q-RPT is active.
Arguments	<i>Mode:</i> "A" Absolute mode "G" Gauge mode "N" Negative gauge mode "D" Differential mode (available only for the Hi Q-RPT)  <u>Measured pressure values are returned with "g" to identify measurement mode for both gauge and negative gauge measurement modes. Differential mode restricts access to settings on the Lo Q-RPT.</u>
Remarks	The measurement mode can also be set using the "UNIT" command but the "UNIT" command does not distinguish between gauge and negative gauge in it's reply, while the "MMODE" does. Measurement mode is range specific.
Example (enhanced)	Cmd sent: "MMODE A" Query reply: "A" (No reply if IEEE-488)
Example (enhanced)	Cmd sent: "MMODE? A" Query reply: "A"
Example (enhanced)	Cmd sent: "MMODE=G" Query reply: "G"
Errors	ERR# 6: Invalid argument text. ERR# 7: Abs mode only with altitude units or gauge mode only with gauge Q-RPT. ERR#10: The suffix indicating the Q-RPT is invalid for the current conditions. ERR# 20: Absolute or negative gauge mode not available with gauge Q-RPT. Absolute Q-RPT with an absolute and negative gauge OFF calibration. The current range cannot support gauge mode. ERR# 53: Gauge mode range would be negative. Lo Q-RPT not suitable for differential mode.
See Also	"UNIT", "ARANGE" 3.3.3

MSGFMT	
Purpose	Read or set the type of program command format to use (enhanced or classic).
Command	"MSGFMT <i>mode</i> "
Query	"MSGFMT?"
Classic	"MSGFMT= <i>mode</i> " "MSGFMT"
Arguments	<i>mode</i> : '1' to use the enhanced command format. '0' to use the classic command format.
Defaults	"MSGFMT 0"
Remarks	The user can select the type of remote command format to use. This format must agree with the format sent to the RPM4 The enhanced query form of this command ("MSGFMT? <i>n</i> ") should always be used to set the desired format, as it will be accepted regardless of the current format (classic or enhanced). It is recommended to use the "L2" and "L3" commands instead of this command for new designs.
Example (enhanced)	Cmd sent: "MSGFMT 1" Query reply: "1" (No reply if IEEE-488)
Example (enhanced)	Cmd sent: "MSGFMT? 1" Query reply: "1"
Example (classic)	Sent: "MSGFMT=1" Reply: "MSGFMT=1"
Errors	ERR# 6: Missing or improper program message argument(s).
See Also	"L2 / L3" 4.3, 3.5.2.3

NVENT_n	
Purpose	Read or set the status of low (negative) vent valve (Gxxx or BGxxx Q-RPT only)
Command	"NVENT _n <i>mode</i> "
Query	"NVENT _n ?"
Classic	"NVENT _n = <i>mode</i> " "NVENT _n "
Default	"NVENT _n AUTO"
Optional Suffix	" <i>n</i> " The active Q-RPT is assumed if no suffix is given. The "Hi" Q-RPT is assumed if the HL Q-RPT is active and no suffix is given. '1' Specify the Hi Q-RPT '2' Specify the Lo Q-RPT
Arguments	<i>Mode</i> : '0' to close the low vent valve. '1' to open the low vent valve. 'AUTO' for the RPM4 to automatically open and close the low vent valve.
Remarks	Gxxx or BGxxx Q-RPTs each have a low vent valve that is used to vent the TEST(-) port. This valve is normally controlled automatically depending on current RPM4 operation but it can be commanded to open or close using the "NVENT" command. The reply includes two fields. The first indicates the low vent status. The second indicates whether the low vent function is AUTO or MANUAL
Example (enhanced)	Cmd sent: "NVENT? 0" Query reply: "0, MANUAL"
Example (enhanced)	Cmd sent: "NVENT? AUTO" Query reply: "1, AUTO"
Example (classic)	Sent: "NVENT=1" Query reply: "0, MANUAL"
See Also	3.5.7.4

PCALn	
Purpose	Read or set the calibration information for the Hi or Lo Q-RPT.
Command	"PCAL n <i>adder, mult, CalDate</i> "
Query	"PCAL n ?"
Classic	"PCAL n = <i>adder, mult, CalDate</i> " "PCAL n "
Defaults	"PCAL n = 0.0, 1.0, 19800101"
Optional Suffix	" n " The active Q-RPT is assumed if no suffix is given. The Hi Q-RPT is assumed if the HL Q-RPT is active and no suffix is given. '1' Specify the Hi Q-RPT '2' Specify the Lo Q-RPT
Arguments	<i>Adder</i> : The Q-RPT calibration adder (PA). In Pascal. <i>Mult</i> : The Q-RPT calibration multiplier (PM) from 0.1 to 100. <i>CalDate</i> : The date of the calibration in the format "YYYYMMDD" by default. Any other format up to 8 characters long is also accepted, and the replied format is in th previously entered format.
Remarks	The user defined pressure calibration information for the specified Q-RPT (Hi or Lo) can be accessed with this program message. The HL Q-RPT does not have it's own calibration information. Using this program message overwrites the current calibration coefficients, so caution must be used. Changes made using this program message take effect immediately. For compatibility with the obsolete style PPC3 "PCAL:HI" and "PCAL:LO" commands, ":HI" and ":LO" can be used in place of the suffix " n " but this is not recommended for new applications.
Example (enhanced)	Cmd sent: "PCAL2? 2.1, 1.000021, 20011201" Query reply: " 2.10 Pa, 1.000021, 20011201" (No reply if GPIB-488)
Example (enhanced)	Cmd sent: "PCAL? 2.1, 1.000021, 20011201" Query reply: " 2.10 Pa, 1.000021, 20011201"
Example (enhanced)	Cmd sent: "PCAL:HI? 2.1, 1.000021, 20011201" (PPC3 style is OK) Query reply: " 2.10 Pa, 1.000021, 20011201"
Example (classic)	Sent: "PCAL1=2.1, 1.000021, 20011201" Reply: " 2.10 Pa, 1.000021, 20011201"
Errors	ERR# 6: One of the arguments is out of range. ERR# 10: The suffix is invalid.
See Also	5.2

PRn	
Purpose	Read the next available pressure measurement.
Query	"PR n ?"
Classic	"PR n "
Optional Suffix	" n " The active Q-RPT is assumed if no suffix is given. '1' Specify the Hi Q-RPT if the Hi and Lo Q-RPTs are NOT OFF Specify the HL Q-RPT if the Hi and Lo Q-RPTs are OFF '2' Specify the Lo Q-RPT '3' Specify the HL Q-RPT if the HL Q-RPT is active
Remarks	The next available pressure value for the specified or active Q-RPT is read in the current pressure units. The data returned also contains <i>Ready/Not Ready</i> information, and the pressure unit of measure and measurement mode. The reply field is always 20 characters long. The first 3 characters of the reply are reserved for the ready status. The ready status is described in the "SR" program message. The pressure value and pressure unit of measure are right justified in this field. After receiving this program message, the RPM4 replies back with the data after a new pressure measurement cycle is complete. This can take up to the current read rate period (1.2 seconds by default).
Example (enhanced)	Query sent: "PR?" Query reply: "R 1936.72 kPa a"
Example (classic)	Query sent: "PR" Reply: "R 1936.72 kPa a"
See Also	"PRR", "QPRR", "SR", "ABORT", "READRATE" 3.1.1, 3.2.1, 3.5.7.2

PRR	
Purpose	Read the next available <i>Ready</i> condition, pressure measurement, rate and on-board barometer reading.
Query	"PRR?"
Classic	"PRR"
Optional Suffix	"n" The active Q-RPT is assumed if no suffix is given. '1' Specify the Hi Q-RPT if the Hi and Lo Q-RPTs are NOT OFF Specify the HL Q-RPT if the Hi and Lo Q-RPTs are OFF '2' Specify the Lo Q-RPT '3' Specify the HL Q-RPT if the HL Q-RPT is active
Remarks	The next available <i>Ready</i> condition, Q-RPT pressure measurement, rate of pressure change, and barometric pressure is replied in the current pressure unit of measure. . This can take up to the current read rate period (1.2 seconds by default). Each data field is separated by a comma, and is returned in the following order: ready, pressure UNITS, rate UNITS/s, atm UNITS Here are the field descriptions: ready: Three character ready status field. Refer to the "SR" command. pressure: The measured pressure for the active Q-RPT in the current pressure unit. This is followed by the current pressure unit. rate: The measured rate of pressure change for the active Q-RPT in the current pressure unit per second. This is followed by the current pressure unit of measure. atm: The pressure measured by the RPM4 on-board barometer in the current pressure unit (and always absolute). This is followed by the current pressure unit. Not all RPM4s are equipped with an on-board barometer. This field is missing if the RPM4 is not equipped with an on-board barometer.
Example (enhanced)	Query sent: "PRR?" Query reply: "R,2306.265 kPaa,0.011 kPa/s,97.000 kPa a" "R,2306.265 kPaa,0.011 kPa/s" (no barometer)
Example (classic)	Query sent: "PRR" Reply: "R,2306.265 kPaa,0.011 kPa/s,97.000 kPa a"
See Also	"PR", "QPRR", "SR" 3.1.1, 3.2.1, 3.5.7.1

QPRR	
Purpose	Read the last Q-RPT pressure measurement, pressure rate and on-board barometer output immediately.
Query	"QPRR?"
Classic	"QPRR"
Optional Suffix	"n" The active Q-RPT is assumed if no suffix is given. '1' Specify the Hi Q-RPT if the Hi and Lo Q-RPTs are NOT OFF Specify the HL Q-RPT if the Hi and Lo Q-RPTs are OFF '2' Specify the Lo Q-RPT '3' Specify the HL Q-RPT if the HL Q-RPT is active
Remarks	The last measured <i>Ready/Not Ready</i> condition, active Q-RPT pressure measurement, rate of pressure change, and barometric pressure is replied in the current pressure unit of measure immediately. This program message is useful when a rapid response of measured pressure is needed. It does not result in quicker pressure measurements. Each data field is separated by a comma, and is returned in the following order: Ready, pressure UNITS, rate UNITS/s, atm UNITS Here are the field descriptions: ready: Three character ready status field. Refer to the "SR" command. pressure: The measured pressure for the selected Q-RPT in the current pressure unit. This is followed by the current pressure unit and measurement mode. rate: The measured rate of pressure change for the active Q-RPT in the current unit of pressure per second. This is followed by the current pressure unit. atm: The pressure measured by the RPM4 on-board barometer in the current pressure unit (but always absolute). This is followed by the current pressure unit. Not all RPM4s are equipped with an on-board barometer. This field is missing if the RPM4 is not equipped with a barometer.
Example (enhanced)	Query sent: "QPRR?" Query reply: "R,2306.265 kPa a,0.011 kPa/s,97.000 kPa a" "R,2306.265 kPa a,0.011 kPa/s" (no barometer)
Example (classic)	Query sent: "QPRR" Reply: "R,2306.265 kPa a,0.011 kPa/s,97.000 kPa a"
See Also	"PR", "PRR", "SR" 3.1.1, 3.2.1, 3.5.7.1

RANGE	
Purpose	Change the active range to the default range of the Hi, Lo or HL Q-RPT. Replies the active range full scale, pressure unit and measurement mode.
Command Query	"RANGE <i>Rng</i> " "RANGE?"
Classic	"RANGE= <i>Rng</i> " "RANGE "
Default	"RANGE IH" <i>Rng</i> : "IH" for the Hi Q-RPT "IL" for the Lo Q-RPT "HL" for the HL Q-RPT
Remarks	The active Q-RPT must be selected before making changes to settings that are dependent on the range. Q-RPTs selected with this command are used with their full default pressure range. The reply indicates the active range in psi if the RPM4 is a "US" version or in kPa if the RPM4 is an "SI" version. Used as a simple query, the active range is returned, which can be an AutoRanged range or a default range (see "ARANGE" cmd).
Example (enhanced)	Cmd sent: "RANGE? IL" (select internal Lo Q-RPT in it's full default range) Query reply: "2.2 psi g,IL"
Example (classic)	Sent: "RANGE= IH" (select internal Hi Q-RPT in it's full default range) Reply: "1000 psi a, IH"
Example (classic)	Sent: "RANGE" (request current range) Reply: "220 psi a,IL"
Errors	ERR# 6: Invalid <i>Rng</i> argument. ERR# 29: The selected Q-RPT is not available.
See Also	"ARANGE", "RPT" 3.2.3, 3.3.1, 3.3.4

RATEn	
Purpose	Read the next available pressure rate of change.
Query	"RATE n ?"
Classic	"RATE n "
Optional Suffix	" n " The active Q-RPT is assumed if no suffix is given. '1' Specify the Hi Q-RPT if the Hi and Lo Q-RPTs are NOT OFF Specify the HL Q-RPT if the Hi and Lo Q-RPTs are OFF '2' Specify the Lo Q-RPT '3' Specify the HL Q-RPT if the HL Q-RPT is active
Remarks	The next available pressure rate of change in the current pressure unit per second is returned. After receiving this program message, the RPM4 replies back with the data once a new pressure measurement cycle is complete. This can take up to the current read rate period (1.2 seconds by default).
Example (enhanced)	Query sent: "RATE?" Query reply: "0.01 kPa/s"
Example (classic)	Sent: "RATE2" Reply: "0.03 kPa/s"
See Also	"PRR", "QPRR". "READRATE" 3.3.6.2

READRATEn	
Purpose	Read or set the specified or active Q-RPT read rate or auto read rate mode.
Command	"READRATE n <i>period</i> "
Query	"READRATE n ?"
Classic	"READRATE n = <i>period</i> " "READRATE n "
Optional Suffix	" n " The active Q-RPT is assumed if no suffix is given. '1' Specify the Hi Q-RPT if the Hi and Lo Q-RPTs are NOT OFF and the HL Q-RPT is not active. Specify the HL Q-RPT if the Hi and Lo Q-RPTs are OFF '2' Specify the Lo Q-RPT if the HL Q-RPT is not active and measurement mode is not differential. '3' Specify the HL Q-RPT if the HL Q-RPT is active.
Arguments	" <i>period</i> ": Period to integrate the measurement over (ms). Can be from 200 ms to 20000 ms. Set to '0' to enable automatic read rate.
Remarks	The RPM4 can have the speed in which it integrates each measurement ("read rate") automatically adjusted based on the rate, or it can manually set to a fixed period. Increasing the read rate increases the reply time for pressure and rate queries. In differential mode and when using the HL Q-RPT, the Lo Q-RPT read rate is always set to the same read rate as the Hi.
Example (enhanced)	Cmd sent: "READRATE 1000" Query reply: "1000" (No reply if GPIB-488)
Example (enhanced)	Cmd sent: "READRATE? 1000" Query reply: "1000"
Example (classic)	Sent: "READRATE=1000" Reply: "1000"
Errors	ERR# 6: The " <i>period</i> " argument is out of range. ERR#10: The suffix ' n ' is invalid
See Also	"PR", "PRR", "SR" 3.5.7.2

READYCKn	
Purpose	Read or set the <i>Ready</i> check flag.
Command	"READYCK n 1"
Query	"READYCK n ?"
Classic	"READYCK n =1" "READYCK n "
Optional Suffix	" n " The active Q-RPT is assumed if no suffix is given. '1' Specify the Hi Q-RPT if the Hi and Lo Q-RPTs are NOT OFF Specify the HL Q-RPT if the Hi and Lo Q-RPTs are OFF '2' Specify the Lo Q-RPT '3' Specify the HL Q-RPT if the HL Q-RPT is active
Remarks	The internal ready check flag is cleared whenever the specified or active Q-RPT reaches a <i>Not Ready</i> (NR) condition. The "READYCK" query returns the status of the flag. The flag is set by sending the "READYCK 1" program message while the Q-RPT is in a <i>Ready</i> condition. The "READYCK" program message query can then be used at a later time to determine whether a <i>Not Ready</i> condition has occurred since the ready check flag was set.
Example (enhanced)	Cmd sent: "READYCK1 1" Query reply: "1" (no reply if GPIB-488)
Example (enhanced)	Cmd sent: "READYCK1?" Query reply: "1"
Example (enhanced)	Cmd sent: "READYCK?" Query reply: "1" (if Q-RPT condition has stayed <i>Ready</i>) "0" (if Q-RPT condition has NOT stayed <i>Ready</i>)
Example (classic)	Sent: "READYCK=1" Query reply: "READYCK=1"
Example (classic)	Sent: "READYCK" Query reply: "READYCK=1" (if Q-RPT condition has stayed <i>Ready</i>) "READYCK=0" (if Q-RPT condition has NOT stayed <i>Ready</i>)
Errors	ERR# 6: Argument is not a '0' or a '1'.
See Also	"SR" 3.2.1

REMOTE	
Purpose	Lock out the front panel keypads during remote operation.
Command	"REMOTE"
Classic	"REMOTE"
Remarks	The RPM4 goes into remote mode whenever communications take place. The user can return to local operation by pressing the [ESC] key. The REMOTE program message locks out the front panel completely. The only way to unlock the front panel after the "REMOTE" command is using the "LOCAL" program message, the IEEE-488 "GTL" command, or by cycling the RPM4 power.
Example (enhanced)	Cmd sent: "REMOTE" Reply: "REMOTE" (no reply if IEEE-488)
Example (enhanced)	Cmd sent: "REMOTE?" Reply: "REMOTE"
Example (classic)	Sent: "REMOTE" Reply: "REMOTE"
See Also	"LOCAL"

RES_n	
Purpose	To read or set the pressure display resolution for the active range.
Command	"RES _n res"
Query	"RES _n "
Classic	"RES _n = res" "RES _n "
Default	"RES _n =0.001"
Optional Suffix	" <i>n</i> " The active Q-RPT is assumed if no suffix is given. '1' Specify the Hi Q-RPT if the Hi and Lo Q-RPTs are NOT OFF Specify the HL Q-RPT if the Hi and Lo Q-RPTs are OFF '2' Specify the Lo Q-RPT '3' Specify the HL Q-RPT if the HL Q-RPT is active
Arguments	res: The pressure display resolution in % span of the specified Q-RPT range (0.0001 to 1 % FS).
Remarks	The pressure display resolution is defined as % span of the active range. The setting is separate for each range, and changes as the range is changed.
Example (enhanced)	Cmd sent: "RES .01" Query reply: "0.01" (No reply if GPIB-488)
Example (enhanced)	Cmd sent: "RES? .01" Query reply: "0.01"
Example (classic)	Sent: "RES=.01" Reply: "0.01"
Errors	ERR# 6 The argument is invalid.
See Also	3.4.2

RESET	
Purpose	Reset the user's settings to factory defaults.
Command	"RESET"
Classic	"RESET"
Remarks	The RPM4 has user settings (units, resolution, etc.) that can be reset to factory defaults. The remote "RESET" program message corresponds to the front panel "Reset - Sets". System calibration coefficients and communications settings are not affected. The reset cycle takes up to 3 seconds to complete. Remote communications should not take place during this period.
Example (enhanced)	Cmd sent: "RESET" Reply: "RESET" (no reply if IEEE-488)
Example (enhanced)	Cmd sent: "RESET?" Reply: "RESET"
Example (classic)	Sent: "RESET" Reply: "RESET"
See Also	3.5.9.1

RPTn	
Purpose	Read the available Q-RPT identification data.
Query	"RPTn"
Classic	"RPTn"
Optional Suffix	"n" The active Q-RPT is assumed if no suffix is given. '1' Specify the Hi Q-RPT if the Hi and Lo Q-RPTs are NOT OFF Specify the HL Q-RPT if the Hi and Lo Q-RPTs are OFF '2' Specify the Lo Q-RPT '3' Specify the HL Q-RPT if the HL Q-RPT is active
Remarks	Up to two (three including the HL Q-RPT which is a combination of the Hi and Lo) internal Q-RPTs can be available for use in an RPM4. You can query the RPM4 for information about each particular Q-RPT. The Q-RPT data is returned in the following format: <i>RPTLabel</i> , <i>Q-RPTLocator</i> , <i>Serial#</i> , <i>RngGa</i> , <i>RngAbs</i> , <i>Q-RPTMode</i> <i>RngLabel</i> : RPT type label. This label identifies the Q-RPT type and range. This is the same label used on the RPM4 front panel screen. <i>RptLocator</i> : Text field identifying the Q-RPT position in the RPM4 system. "IH" identifies this as an internal, Hi Q-RPT "IL" identifies this as an internal, Lo Q-RPT <i>Serial#</i> : The serial number of the Q-RPT. <i>RngGa</i> : The Q-RPT default gauge mode range in the current pressure unit. <i>RngAbs</i> : The Q-RPT default absolute mode range in the current pressure unit. "NONE" appears in the field if the Q-RPT is a Gxxx, BGxxx or Axxx with absolute and negative gauge modes OFF. <i>RptMode</i> : 'A' if Q-RPT is Axxx and supports absolute, gauge and negative gauge measurement modes. 'G' if Q-RPT is gauge Gxxx or Axxx with absolute and negative gauge modes OFF and supports only gauge measurement mode. 'N' if Q-RPT is BGxxx and supports gauge and negative gauge measurement modes.
Example (enhanced)	Cmd sent: "RPT2?" (Get information on the Lo Q-RPT) Query reply: "A350K, IL, 82345, 35, 50,A"
Example (classic)	Cmd sent: "RPT3" (Get information on the HL Q-RPT) Query reply: "A7M, HL, 82345, 1000, 1000,A"
Errors	ERR#4: External device not detected. ERR# 10: Invalid suffix.
See Also	3.2.3, 3.2.4

SDSn	
Purpose	Read or set the OPEN/CLOSE status for the specified or active Q-RPT SDS systems. This is equivalent to use of the SDS temporary OPEN/CLOSE function from the RPM4 front panel.
Command Query	"SDSn close" "SDSn"
Classic	"SDSn=close" "SDSn"
Default	"SDSn=1"
Optional Suffi	"n" The active Q-RPT is assumed if no suffix is given. '1' Specify the Hi Q-RPT's SDS if the Hi and Lo Q-RPTs are NOT OFF Specify the HL Q-RPT's SDS if the Hi and Lo Q-RPTs are OFF '2' Specify the Lo Q-RPT's SDS. '3' Specify the HL Q-RPT's SDS if the HL Q-RPT is active
Arguments	"close": '0' to OPEN the SDS system. '1' to CLOSE the SDS system.
Remarks	Each Q-RPT of designation A7M or less can have an "SDS" system, which can be either "OPEN" or "CLOSED". This command allows access to each one without affecting the other, regardless of whether the SDS for the selected Q-RPT is currently full time "ON" or "OFF". Caution must be used in differential mode or when using the HL Q-RPT, as this command can allow you to have one Q-RPT open while the other Q-RPT is closed. If the "HL" Q-RPT SDS is specified, then both the Hi and the Lo Q-RPT SDS will be affected. This command does not affect the power up status of the SDS system.
Example (enhanced)	Cmd sent: "SDS2? 1" (close the Lo Q-RPT SDS) Query reply: "4"
Example (classic)	Cmd sent: "SDS1=0" (open the Hi Q-RPT SDS) Query reply: "SDS1=0"
Errors	ERR# 7: Argument not a '0' or a '1' ERR# 10: Invalid suffix. ERR# 23: SDS not installed on this Q-RPT and pressure is close to ATM. ERR# 53: SDS not installed on this Q-RPT and pressure not close to ATM.
See Also	"SDSAUTO", "SDSACT" 3.2.7, 3.3.8, 3.5.4

SDSACT	
Purpose	Read or set the status for both the Hi and Lo Q-RPT's SDS systems. This is equivalent to use of the [SDS] key from the RPM4 front panel.
Command Query	"SDS state" "SDS"
Classic	"SDS=state" "SDS"
Default	"SDS=1"
Arguments	"state": '0' OPEN the SDS system on the active Q-RPT and CLOSE the SDS system on the "inactive" Q-RPT. '1' to CLOSE the SDS system on both Q-RPTs.
Remarks	This command can be used to select one Q-RPT at a time, ensuring that the "inactive" Q-RPT SDS is closed. If a Q-RPT's SDS is full time "OFF", then it is not be affected by this command. The status of the active Q-RPT's SDS system is replied. If the RPM4 is in differential mode or the HL Q-RPT is active, then this command opens or close both the Hi and Lo SDS at the same time, unless the SDS is full time "off".
Example (enhanced)	Cmd sent: "SDS? 1" Query reply: "1"
Example (classic)	Cmd sent: "SDS=0" Query reply: "SDS=0"
Errors	ERR# 7: Argument not a '0' or a '1' ERR# 10: Invalid suffix or command argument. ERR# 23: SDS not installed on this Q-RPT
See Also	"SDSAUTO", "SDS" 3.2.7, 3.3.8, 3.5.4

SDSAUTOn	
Purpose	Read or set the automatic full time ON/OFF status for the specified or active Q-RPT SDS systems. This is equivalent to use of the SDS full time ON/OFF function from the RPM4 front panel.
Command Query	"SDSAUTO n on" "SDSAUTO n "
Classic	"SDSAUTO n =on" "SDSAUTO n "
Default	"SDSAUTO n =1"
Optional Suffix	" n " The active Q-RPT is assumed if no suffix is given. If the "HL" Q-RPT is the active Q-RPT, and no suffix is specified, then the "Hi" Q-RPT is assumed '1' Specify the Hi Q-RPT SDS '2' Specify the Lo Q-RPT SDS
Arguments	" on": '0' to turn the SDS system OFF. '1' to turn the SDS system ON
Remarks	Turning an SDS system to full time "OFF" or "ON" affects how the remote command "SDSACT" and the front panel SDS button can affect each Q-RPT's SDS system.
Example (enhanced)	Cmd sent: "SDSAUTO2? 1" Query reply: "1"
Example (classic)	Cmd sent: "SDSAUTO1=0" Query reply: "SDSAUTO1=0"
Errors	ERR# 7: Argument not a '0' or a '1' ERR# 10: Invalid suffix. ERR# 23: SDS not installed on this Q-RPT
See Also	"SDSACT", "SDS" 3.2.7, 3.3.8, 3.5.4,

SCRSAV	
Purpose	Read or set the front panel display screen saver activation time.
Command Query	"SCRSAV n " "SCRSAV?"
Classic	"SCRSAV= n " "SCRSAV"
Arguments	n : The inactivity period (0 – 99 minutes) after which screen saver activates.
Default	"SCRSAV 10"
Remarks	The RPM4 front panel will dim after a period of keyboard and remote inactivity. Setting this value to '0' disables this feature.
Example (enhanced)	Cmd sent: "SCRSAV 30" Query reply: "30" (No reply if GPIB-488)
Example (enhanced)	Cmd sent: "SCRSAV? 30" Query reply: "30"
Example (classic)	Sent: "SCRSAV=30" Reply: "30"
Errors	ERR# 6 The argument was invalid.
See Also	3.5.5.1

SN	
Purpose	To read the serial number of the RPM4.
Query	"SN?"
Classic	"SN"
Remarks	The RPM4 is serialized. The serial number can be read using this program message.
Example (enhanced)	Query sent: "SN?" Query reply: "321"
Example (classic)	Sent: "SN" Reply: "321"
See Also	3.5.5.4

SR	
Purpose	Read the next available <i>Ready/Not Ready</i> status.
Query	"SR?"
Classic	"SR"
Optional Suffix	"n" The active Q-RPT is assumed if no suffix is given. '1' Specify the Hi Q-RPT if the Hi and Lo Q-RPTs are NOT OFF Specify the HL Q-RPT if the Hi and Lo Q-RPTs are OFF '2' Specify the Lo Q-RPT '3' Specify the HL Q-RPT if the HL Q-RPT is active
Remarks	The current <i>Ready</i> status can be read using this program message. Possible replies: "NR" The pressure is not ready within the limits defined by the stability criterion. "R " The pressure meets the ready criteria. The status is replied when the next pressure measurement is finished. "OL" The pressure of one of the active Q-RPTs has exceeded the user defined upper or lower limits. "OP" The pressure of one of the Q-RPTs has exceeded the Q-RPT's maximum limits. "ER" An internal device failure has occurred.
Example (enhanced)	Query sent: "SR?" Query reply: "NR"
Example (classic)	Sent: "SR" Reply: "NR"
See Also	"PR", "PRR", "HS", "SS", "UL", "LL" Commands 3.2.1, 3.4.4, 3.4.4.1

SS%n	
Purpose	Read or set the current stability limit as a % of range.
Command	"SS% <i>limit</i> "
Query	"SS%?"
Classic	"SS%= <i>limit</i> " "SS%"
Optional Suffix	"n" The active Q-RPT is assumed if no suffix is given. '1' Specify the Hi Q-RPT if the Hi and Lo Q-RPTs are NOT OFF Specify the HL Q-RPT if the Hi and Lo Q-RPTs are OFF '2' Specify the Lo Q-RPT '3' Specify the HL Q-RPT if the HL Q-RPT is active
Arguments	<i>limit</i> : The stability limit in %FS of the current active range.
Remarks	The stability limit can be read and set as a percent of the full scale range of the Q-RPT range.
Example (enhanced)	Cmd sent: "SS% .1" Query reply: "0.10 %"(No reply from GPIB-488)
Example (enhanced)	Cmd sent: "SS%? .1" Query reply: "0.10 %"
Example (classic)	Sent: "SS%=.1" Reply: "0.10 %"
Errors	ERR# 6: The argument was invalid. ERR# 10: Invalid or missing command suffix.
See Also	"SS" 3.4.3

SSn	
Purpose	Read or set the current pressure stability limit.
Command	"SS <i>limit</i> "
Query	"SS?"
Classic	"SS= <i>limit</i> " "SS"
Optional Suffix	" <i>n</i> " The active Q-RPT is assumed if no suffix is given. '1' Specify the Hi Q-RPT if the Hi and Lo Q-RPTs are NOT OFF Specify the HL Q-RPT if the Hi and Lo Q-RPTs are OFF '2' Specify the Lo Q-RPT '3' Specify the HL Q-RPT if the HL Q-RPT is active
Arguments	<i>Limit</i> : The stability limit in the current pressure unit of measure.
Remarks	The stability limit can be read and set as a pressure. The stability limit is used as the <i>Ready/Not Ready</i> criteria..
Example (enhanced)	Cmd sent: "SS .1" Query reply: "0.10 kPa/s" (No reply from GPIB-488)
Example (enhanced)	Cmd sent: "SS? .1" Query reply: "0.10 kPa/s"
Example (classic)	Sent: "SS=.1" Reply: "0.10 kPa/s"
Errors	ERR# 6: The argument was invalid. ERR# 10: Invalid or missing command suffix.
See Also	"SS%" 3.4.3

TIME	
Purpose	Read or set the RPM4 internal clock.
Command	"TIME <i>hh:mmXX</i> "
Query	"TIME?"
Classic	"TIME= <i>hh:mmXX</i> " "TIME"
Arguments	<i>hh:mm</i> : The time in a 12 hour format using a colon delimiter <i>XX</i> : "am" or "pm"
Example (enhanced)	Cmd sent: "TIME 12:52PM" Query reply: "12:52pm" (No reply if GPIB-488)
Example (enhanced)	Cmd sent: "TIME? 12:52PM" Query reply: "12:52pm"
Example (classic)	Sent: "TIME=12:52PM" Reply: "12:52pm"
Errors	ERR# 7: Missing or improper program message argument(s).
See Also	"DATE" 3.5.5.3

UCOEFn	
Purpose	To identify the coefficient used to convert 1 Pascal to the current pressure unit of measure.
Query	"UCOEF <i>n</i> ?"
Classic	"UCOEF <i>n</i> "
Optional Suffix	" <i>n</i> " The active Q-RPT is assumed if no suffix is given. '1' Specify the Hi Q-RPT if the Hi and Lo Q-RPTs are NOT OFF Specify the HL Q-RPT if the Hi and Lo Q-RPTs are OFF '2' Specify the Lo Q-RPT '3' Specify the HL Q-RPT if the HL Q-RPT is active
Remarks	The RPM4 handles all pressure values internally in Pascal. The coefficient replied is equivalent of 1 Pa in the current pressure unit of measure. This program message allows the user to convert pressures
Example (enhanced)	Query sent: "UCOEF?" Query reply: "0.0010000000"
Example (classic)	Sent: "UCOEF" Reply: "0.0010000000"
See Also	3.3.2, 3.5.6, 7.2.1

UDU	
Purpose	Read or set the user defined pressure unit.
Command	"UDU <i>label</i> , <i>ucoef</i> "
Query	"UDU?"
Classic	"UDU= <i>label</i> , <i>ucoef</i> " "UDU" <i>label</i> : User unit label (4 alphanumeric char maximum). It cannot be an already supported unit label. <i>Ucoef</i> : "User unit conversion coefficient (units/Pa).
Default	"UDU USER,1.0"
Remarks	The user defined unit must be set up with the program message prior to remote or local selection.
Example (enhanced)	Cmd Sent: "UDU MYUN, .001" Query reply: "MYUN, 0.001000" (No reply if GPIB-488)
Example (enhanced)	Cmd Sent: "UDU? MYUN, .001" Query reply: "MYUN, 0.001000"
Example (enhanced)	Sent: "UDU=MYUN, .001" Reply: "MYUN, 0.001000"
Errors	
See Also	3.5.6, 3.3.2

ULn	
Purpose	Read or set an upper limit for the specified or active Q-RPT.
Command	"ULn <i>limit</i> "
Query	"ULn?"
Classic	"ULn= <i>limit</i> " "ULn"
Optional Suffix	" <i>n</i> " The active Q-RPT is assumed if no suffix is given. '1' Specify the Hi Q-RPT if the Hi and Lo Q-RPTs are NOT OFF and the HL Q-RPT is not active. Specify the HL Q-RPT if the Hi and Lo Q-RPTs are OFF '2' Specify the Lo Q-RPT if the HL Q-RPT is not active and measurement mode is not differential. '3' Specify the HL Q-RPT if the HL Q-RPT is active.
Arguments	" <i>limit</i> ": The upper limit pressure in the specified Q-RPT's current pressure unit and measurement mode. If the unit is meters, this value is be interpreted in kPa. If the unit is feet, this value is be interpreted in psi.
Remarks	The RPM4 has an upper limit for each range and for each measurement mode (gauge, absolute, and differential). If the pressure does exceed the upper limit, the pressure display flashes. This feature should always be used to prevent accidental over pressure of a device under test.
Example (enhanced)	Cmd sent: "UL 1000" Query reply: "1000.00 kPa a" (No reply if GPIB-488)
Example (enhanced)	Cmd sent: "UL? 1000" Query reply: "1000.00 kPa a"
Example (classic)	Sent: "UL=1000" Reply: "1000.00 kPa a"
Errors	ERR# 6: The " <i>limit</i> " argument is out of range.
See Also	"LL" 3.4.4

UNITn	
Purpose	Read or set the pressure unit of measure unit and measurement mode.
Command	"UNITn unit (, ref)" "UNITn unitn (, ref)"
Query	"UNITn unitg (, ref)" "UNITn unita (, ref)" "UNITn unitd (, ref)" "UNITn?"
Classic	"UNITn=unit (, ref)" "UNITn=unitn (, ref)" "UNITn=unitg (, ref)" "UNITn=unita (, ref)" "UNITn=unitd (,ref)" "UNITn"
Optional Suffix	"n" The active Q-RPT is assumed if no suffix is given. '1' Specify the Hi Q-RPT if the Hi and Lo Q-RPTs are NOT OFF and the HL Q-RPT is not active. Specify the HL Q-RPT if the Hi and Lo Q-RPTs are OFF '2' Specify the Lo Q-RPT if the HL Q-RPT is not active and measurement mode is not differential. '3' Specify the HL Q-RPT if the HL Q-RPT is active.
Arguments	<i>Unit:</i> The text corresponding to the pressure unit of measure. A unit mode character can optionally be added to the end of the units: 'a' for absolute measurement mode. 'g' for gauge measurement mode. 'n' for negative gauge measurement mode. 'd' for differential measurement mode (Hi Q-RPT only) <i>ref:</i> The optional unit reference temperature only if the unit is "InWa"
Remarks	This program message determines what unit of measure and what measurement mode is used to display pressure values. Refer to Table 13 for a detailed list of the units available and their labels. If the unit text is not followed by an explicit mode character ('a', 'g', 'n' or 'd') then "gauge" mode is assumed. There can be a space between the unit text and the 'a', 'g', 'n' or 'd'. If the unit specified is "InWa", an optional second argument "ref" can be set. The "ref" can be 4, 20, or 60 corresponding to InWa at 4 °C, 20 °C or 60 °F. If this second argument is not given when the unit is "InWa", then the reference temperature is assumed to be 20 °C. This can also be added directly onto the end of the <i>Unit</i> argument if desired. The fifth character of the reply is always 'a' for absolute mode, 'g' for gauge/negative gauge mode or 'd' for differential mode. White spaces precede this character if needed. The temperature reference is added to the reply only if the unit is "InWa". The reply includes the measurement mode character in the fifth position, with an 'a' indicating absolute mode, a 'g' indicating gauge or negative gauge mode or a 'd' indicating differential mode. The "MODE" command can also be used to set the desired measurement mode only.
Example (enhanced)	Cmd sent: "UNIT? kPaa" Query reply: "kPaa" Sent: "UNIT? InWag, 4" Query reply: "inWag, 4" Sent: "UNIT? InWaa60" Query reply: "inWaa, 60"
Example (enhanced)	Cmd sent: "UNIT psi n" Query reply: "psi g" ('g' used to indicate both gauge & neg gauge modes)
Example (classic)	Sent: "UNIT=kPaa" Reply: "kPaa" Sent: "UNIT=InWag, 4" Reply: "inWag, 4"
Errors	ERR# 7: The <i>unit</i> is invalid. ERR# 6: The <i>ref</i> is invalid. ERR# 20: Absolute measurement mode and altitude units are not allowed with a gauge Q-RPT.
See Also	"MMODE", "MODE" 3.3.2, 3.3.3, 3.5.6, 7.2.1

VER	
Purpose	Identify the RPM4, US or SI units, the Q-RPT labels and the software version.
Query	"VER?"
Classic	"VER"
Remarks	The software version of the RPM4 can be read. This is useful for checking for the presence of the RPM4 and for reference purposes. It indicates the internal Q-RPT(s) and software version.
Example (enhanced)	Query sent: "VER?" Query reply: "DH INSTRUMENTS, INC RPM4 us A350K/BG15K Ver1.00 "
Example (classic)	Query sent: "VER?" Query reply: "DH INSTRUMENTS, INC RPM4 us A350K/BG15K Ver1.00 "
See Also	"ID", "**IDN?" None

ZOFFSETn	
Purpose	Read or set the AutoZ pressure offset (P_{offset}) for the specified or active Q-RPT in the current measurement mode.
Command Query	"ZOFFSET n GaOffset , AbsOffset , DifOffset" "ZOFFSET n ?"
Classic	"ZOFFSET n =GaOffset , AbsOffset , DifOffset" "ZOFFSET n "
Defaults	"ZOFFSET n = 0.0, 0.0, 0.0" (Gauge Q-RPT) "ZOFFSET n = 101325, 0.0, 0.0" (Absolute Q-RPT)
Optional Suffix	" n " The active Q-RPT is assumed if no suffix is given. '1' ":HI" Specify the Hi Q-RPT '2' ":LO" Specify the Lo Q-RPT
Arguments	<i>GaOffset</i> : The Q-RPT pressure offset ("Poffset") for Gauge measurement mode (Pa). <i>AbsOffset</i> : The Q-RPT pressure offset for absolute measurement mode (Pa) <i>DifOffset</i> : The Q-RPT pressure offset for differential measurement mode (Pa)
Remarks	The pressure offset (P_{offset}) for the specified Q-RPT (Hi or Lo) can be accessed with this program message. There are separate offsets for gauge, absolute and differential measurement modes, but not all modes apply in all cases. Gauge Q-RPTs do not support " <i>AbsOffset</i> ". " <i>DifOffset</i> " applies only to the "Hi" Q-RPT. Using this program message overwrites the current offset, so caution must be used. Changes made using this program message take effect immediately.
Example (enhanced)	Cmd sent: "ZOFFSET1 2.1, 0, 0" Query reply: " 2.10 Pa, 0.00 Pa, 0.00 Pa"
Example (classic)	Sent: "ZOFFSET=97293.1, 3.02, 0" Reply: " 97293.10, 3.02, 0.00"
Errors	ERR# 6: One of the arguments is out of range.
See Also	3.5.1

4.5 STATUS REPORTING SYSTEM

The RPM4 status reporting system is used to track and report system status and errors. It follows the model of the IEEE Std 488.2 and works for the COM1 and the IEEE-488 port with slight differences. The RPM4 can be programmed to respond to various status conditions by asserting the SRQ of the IEEE-488 interface. The COM1 port cannot be supported in such a way, so polling must be used.

4.5.1 ERROR QUEUE

The RPM4 keeps track of remote errors by using an error queue. If an error occurs, it is pushed onto the Error Queue. If you are using the COM1 port, the error number is immediately replied in the form "ERR#nn where nn is the error code from 0 to 99. The "ERR?" (or "ERR") query can then be used to pull the error from the Error Queue in it's descriptive text format. If you are using the enhanced program message format, the Error Queue will accumulate errors until full unless they are pulled from the queue. If you are using the classic program format, the Error Queue is cleared every time a new program message is received.

4.5.2 STATUS BYTE REGISTER

The RPM4 contains an 8 bit Status Byte Register that reflects the general status of the RPM4.

Table 18. 8 Bit Status Byte Register

OPER	RQS/MSS	ESB	MAV	N/A	ERROR	N/A	RSR
(128)	(64)	(32)	(16)	(8)	(4)	(2)	(1)

This register is affected by the RPM4 reply output queue, the Error Queue, the Standard Event Status register and the *Ready Event* Status register.

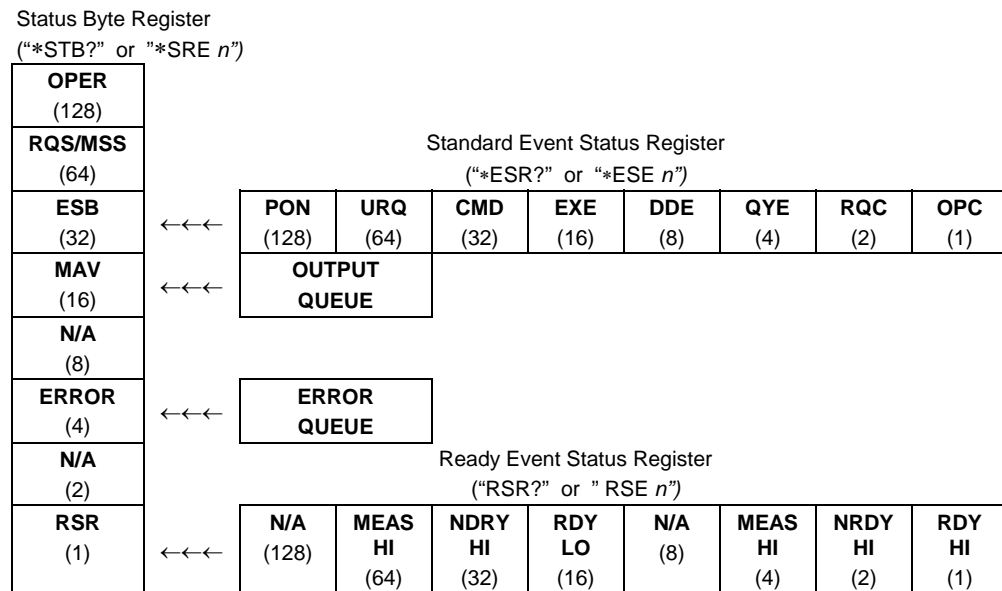

Figure 6. Status Register Schematic

The Status Byte Register can be read using the **"STB?"** query, or by performing a serial poll on the IEEE-488 bus. If you read this using a serial poll then Bit 6 is the RQS. If the **"STB?"** query is used, then bit 6 is the MSS bit. All of the other bits are common to both types of query.

Each of these status bits can cause a SRQ to occur. The Service Request Enable Register (**"SRE"** program message) determines which of these flags are able to assert the SRQ line. This enable register has a matching set of bits that each will enable the designated bit to cause a SRQ, except for the RQS/MSS bit(s) which cannot cause a SRQ. If you set this register to 20 (\$14 hex), an SRQ will occur if the MAV or the ERROR bit are set. The description of these bits are given as:

OPER N/A Bit 7 (128)

RQS Requested Service Bit 6 (64)

Indicates that the SRQ line of the IEEE-488 interface has been asserted by the RPM4. This bit is cleared when a serial poll is performed on the RPM4, and is a part of the Status Byte Register when read using a serial poll. This bit does not apply if the COM1 port is being used.

MSS Master Summary Status Bit 6 (64)

Indicates that an event or events occurred that caused the RPM4 to request service from the Host, much like the RQS bit. Unlike the RQS bit, it is READ ONLY and can be only cleared when the event(s) that caused the service request are cleared.

ESB Event Summary Bit 5 (32)

Indicates if an enabled bit in the Standard Event Status Register became set (see Section 4.5.3).

MAV Message Available Bit 4 (16)

Indicates that at least one reply message is waiting in the RPM4 IEEE-488 output queue.

ERROR Error Queue Not Empty Bit 2 (4)

Indicates that at least one command error message is waiting in the RPM4 IEEE-488 error message queue. Use the **"ERR?"** query to get this message.

RSR Ready Summary Bit 0 (1)

Indicates that an enabled bit in the Ready Status Register became set.

4.5.3 STANDARD EVENT REGISTER

The RPM4 contains an 8 bit Standard event register that reflects specific RPM4 events. Enabled events in this register will set or clear the ESB bit of the Status Byte Register.

Table 19. 8 Bit Standard Event Register

PON	URQ	CMD	EXE	DDE	QYE	RQC	OPC
(128)	(64)	(32)	(16)	(8)	(4)	(2)	(1)

This register can be read using the “*ESR?” query, Each of these status bits can set the ESB bit of the Status Byte Register, causing a SRQ to occur IF the ESB bit is enabled to do so. The Standard Event Status Enable Register (“*ESE” program message) determines which of these flags are able to assert the ESB bit. The description of these bits are given as:

- PON** Power On Bit 7 (128)
Indicates that the RPM4 power has been cycled since the last time this bit was read or cleared.
- URQ** User Request Bit 6 (64)
Indicates that the RPM4 was set to local operation manually from the front panel by the user (pressing the **[ESC]** key).
- CMD** Command Error Bit 5 (32)
Indicates that a remote command error has occurred. A command error is typically a syntax error in the use of a correct program message.
- EXE** Execution Error Bit 4 (16)
Indicates if a remote program message cannot be processed due to device related condition.
- DDE** Device Dependent Error Bit 3 (8)
Indicates that an internal error has occurred in the RPM4 such as a transducer time-out.
- QYE** Query Error Bit 2 (4)
Indicates that an error has occurred in the protocol for program message communications. This is typically caused by a program message being sent to the RPM4 without reading a waiting reply.
- RQC** Request Control Bit 1 (2)
This bit is not supported as the RPM4 cannot become the active controller in charge.
- OPC** Operation Complete Bit 0 (1)
Indicates that the RPM4 has completed all requested functions.

4.5.4 READY STATUS REGISTER

The RPM4 contains an 8 bit Ready Status Register that reflects specific RPM4 Q-RPT measurement ready events. Enabled events in this register will set or clear the RSB bit of the Status Byte Register.

Table 20. 8 Bit Ready Status Register

N/A	MEAS LO	NRDY LO	RDY LO	N/A	MEAS HI	NRDY HI	RDY HI
(128)	(64)	(32)	(16)	(8)	(4)	(2)	(1)

This register can be read using the “*RSR?” query, Each of these status bits can set the RSB bit of the Status Byte Register, causing a SRQ to occur IF the RSB bit is enabled to do so. The Standard Event Status Enable Register (“*RSE” program message) determines which of these flags are able to assert the RSB bit. The description of these bits are given as:

MEAS LO Lo-RPT measurement ready Bit 6 (64)

Indicates that the Hi Q-RPT has completed a Q-RPT measurement.

NRDY LO Lo Q-RPT pressure Not Ready Bit 5 (32)

Indicates that the Hi Q-RPT made a transition from *Ready* to *Not Ready* as defined by the stability settings (see Section 3.2.1).

RDY LO Lo Q-RPT pressure Ready Bit 4 (16)

Indicates that the Hi Q-RPT is *Ready* as defined by the stability settings (see Section 3.2.1).

MEAS HI Hi Q-RPT measurement ready Bit 2 (4)

Indicates that the Hi Q-RPT has completed a Q-RPT measurement.

NRDY HI Hi Q-RPT pressure Not Ready Bit 1 (2)

Indicates that the Hi Q-RPT made a transition from *Ready* to *Not Ready* as defined by the stability settings (see Section 3.2.1).

RDY HI Hi Q-RPT pressure Ready Bit 0 (1)

Indicates that the Hi Q-RPT is *Ready* as defined by the stability settings (see Section 3.2.1).

4.6 IEEE STD. 488.2 COMMON AND STATUS PROGRAM MESSAGES

The RPM4 supports a set of commands that are common to all instruments conforming to IEEE Std. 488.2. These command make it easy to perform basic function for any device that supports these commands. These commands also cover the status reporting commands. See Section 4.5 for details on the status registers mentioned in these commands.

Table 21. Program Message List

*CLS	Clear all of the status & event structures.
*ESE	Read or set the Standard Event Status Enable Register.
*ESR	Read the Standard Event Status Register.
*IDN	Identify the RPM4 version, range, and serial number.
*OPC	Set the operation complete bit when all operations have completed.
*OPT	Read the list of installed RPM4 options.
*RST	Reset the RPM4 settings to factory settings.
*TST	Read the power on self test status.
*SRE	Read or set the Service Request Enable Register.
*STB	Read the Status Byte Register.
*RSE	Read or set the Ready Status Enable Register.
*RSR	Read the Ready Status Register.

4.6.1 PROGRAM MESSAGE DESCRIPTIONS

*CLS	
Purpose	Clear all of the status & event structures.
Command	"*CLS"
Remarks	This program message clears the following events and status registers: Standard Byte Register (STB) Standard Event Status Register (ESR) Error Queue Pending OPC operations
Example	Sent: "*CLS" Reply: none

*ESE	
Purpose	Read or set the Standard Event Status Enable Register.
Command	"*ESE <i>n</i> "
Query	"*ESE?"
Default	"*ESE 0"
Arguments	<i>n</i> : '0 to 255' This is the decimal representation of the bit(s) to enable. To enable the PON and QYE bits, the argument would be 128 + 4 = 132.
Remarks	The Standard Event Status Enable register determines which bits in the standard Event Status Register are enabled and included in the Status Byte Register (ESB bit), and can assert the SRQ line. The reply is in decimal numeric form.
Example (enhanced)	Sent: "*ESE=128"(enables the PON bit) Query reply: "128" (no reply if IEEE-488)
Errors	ERR# 6: <i>n</i> is not valid.

*ESR	
Purpose	Read the Standard Event Register.
Command	"*ESR?"
Remarks	The Standard Event Register contents are cleared after reading. The reply is in decimal numeric form.
Example (enhanced)	Sent: "*ESR?" Reply: "20" (the QYE and EXE bits are set)

*IDN	
Purpose	Identify the RPM4 version, range, and serial number.
Query	"*IDN?"
Remarks	The identification reply is made up of the manufacture, the model, the serial number and the software version. Each is separated by a comma.
Example (enhanced)	Sent:"*IDN?" Reply:"DH INSTRUMENTS INC, RPM4 A0100/A0015, 1234, Ver2.00 -dh"

*OPC	
Purpose	Sets the operation complete bit when all operations have completed.
Command	"*OPC"
Query	"*OPC?"
Remarks	This Command enables the RPM4 to set the OPC bit in the Standard Event Status Register when it has completed all pending functions. The Query replies with a "1" when all functions are complete.
Example (enhanced)	Sent: "*OPC" Query reply: "1"

*OPT	
Purpose	Reads the list of installed RPM4 options.
Query	"*OPT?"
Remarks	This Query returns any registered option(s) installed in the RPM4. Each option is separated by a comma. Possible options: "IEEE-488:0" The IEEE-488 option is installed,
Example (enhanced)	Sent: "*OPT?" Reply: "IEEE-488:0"

*RST	
Purpose	Resets the RPM4 settings to factory settings.
Command	"*RST"
Remarks	This Command sets the RPM4 settings to factory settings. This equivalent to a front panel executed RESET/SET. This does not affect the communications settings.
Example (enhanced)	Sent: "*RST" Reply: "*RST" (no reply if IEEE-488)
See Also	Section 3.5.4.1, <u>Reset – Sets</u>

*SRE	
Purpose	Read or set the Service Request Enable Register.
Command	"*SRE <i>n</i> "
Query	"*SRE?"
Default	"*SRE 0"
Arguments	<i>n</i> : '0 to 255' This is the decimal representation of the bit(s) to enable. To allow the MAV and ESB bits to assert the SRQ line, the argument would be 32 + 16 = 48. Bit 6 (64) is reserved and cannot be set.
Remarks	The Service Request Enable Register determines which bits of the Status Byte can set the MSS bit of the Status Byte and request service by asserting the SRQ line of the IEEE-488 interface.
Example (enhanced)	Sent: "*SRE=48" (enables the MAV and ESB bits) Query reply: "48" (no reply if IEEE-488)
Errors	ERR# 6: <i>n</i> is not valid.

*STB	
Purpose	Read the Status Byte Register.
Command	"*STB?"
Remarks	The Status Byte Register reflects the general status of the RPM4. The 'MSS' bit state is represented by bit 6.
Example (enhanced)	Sent: "*STB?" Reply: "80" (The MSS and MAV bits are set)

*TST	
Purpose	Read the power on self test status.
Query	"*TST?"
Remarks	The RPM4 system memory stores the user settings (units, resolution) and retains them when the unit is OFF. On power-up, this memory is checked. If this memory is corrupted, all user settings are reset to default (as if the "*RST" program message was executed), and the *TST query will return a non zero value. If the RPM4 passed the test on power-up OR if the *TST query was used at least once since the RPM4 was powered up the reply will be a '0'.
Example (enhanced)	Sent: "*RST?" Reply: "1"

*RSE	
Purpose	Read or set the Ready Status Enable Register.
Command	"RSE <i>n</i> "
Query	"RSE?"
Default	"RSE 0"
Arguments	<i>n</i> : '0 to 255' This is the decimal representation of the bit(s) to enable. To enable the RDY bit, the argument would be 1.
Remarks	The Ready Status Enable Register determines which bits in the Ready Status Register are enabled and included in the Status Byte Register (RSR bit), and can assert the SRQ line. The reply is in decimal numeric form.
Example (enhanced)	Sent: "*RSE=1" (enables the RDY bit) Query reply: "1" (no reply if IEEE-488)
Errors	ERR# 6: <i>n</i> is not valid.

*RSR	
Purpose	Read the Ready Status Register.
Command	"RSR?"
Remarks	The Ready Status Register contents are cleared after reading. The reply is in decimal numeric form.
Example (enhanced)	Sent: "RSR?" Reply: "6" (The MEAS and NRDY)

NOTES



5. MAINTENANCE, ADJUSTMENTS AND CALIBRATION

5.1 OVERVIEW

RPM4 was designed for maintenance free operation. No maintenance is required other than:

- Regular AutoZeroing of quartz reference pressure transducer(s) (Q-RPT) (see Section 3.5.1).
- Periodic calibration of Q-RPT(s) (see Section 5.2).
- Adjustment of the on-board barometer, if present (see Sections 5.3).

This section provides information on maintenance, adjustment and calibration procedures, and recommended overhaul procedures.



RPM4 is a sophisticated pressure measuring instrument with advanced on-board features and functions. Before assuming that unexpected behavior is caused by a system defect or breakdown, use this manual and other training facilities to become thoroughly familiar with RPM4 operation.

For rapid assistance in specific situations see Chapter 6 for troubleshooting information.



RPM4 is covered by a limited one (1) year warranty. Unauthorized service or repair during the warranty period is undertaken at the owner's risk and may cause damage that is not covered under warranty and/or may void the warranty. For warranty service, contact a DHI Authorized Service Provider (see Table 29).

5.2 CALIBRATION OF QUARTZ REFERENCE PRESSURE TRANSDUCERS (Q-RPTS)

5.2.1 PRINCIPLE

RPM4 is equipped with one or two quartz reference pressure transducers (Q-RPTs) used for low uncertainty pressure measurement.

To calibrate a Q-RPT, pressures from a reference standard are applied to the Q-RPT at ascending and descending pressure increments over the range. The recommended pressure sequence for a calibration varies depending on whether the Q-RPT is of Standard or Premium class (see Section 1.2.2.1). The pressure defined by the standard and the corresponding Q-RPT readings are recorded at each point. After all of the pressures have been applied and recorded, adjustments are made to fit the Q-RPT pressure readings to the standard. Fitting the readings means performing a linear regression to arrive at the lowest value of the residuals of errors of the Q-RPT relative to the standard. The Q-RPT output is adjusted by user settable coefficients: PA (an adder or offset) and PM (a multiplier or span set) (see Section 5.2.1.1).

The calibration process is performed independently on each Q-RPT to arrive at its optimal fit.



CalTool for RPTs software provided with the RPM4 supports the calibration process of RPM4 Q-RPTs. CalTool and its documentation are provided on a General Accessories Disk with a new RPM4 and can be downloaded from www.dhstruments.com. Most users should use CalTool software to assist in the calibration of RPM4.

RPM4 is delivered with an interactive Q-RPT calibration utility that steps the operator through the complete Q-RPT calibration procedure including applying the necessary pressures, collecting data automatically, calculating new PA and PM values, previewing the results of the new calibration and activating the results of the new calibration (see the CalTool for RPTs manual on the General Accessories Disk). RPM4 also provides complete front panel and remote access to Q-RPT calibration parameters so that Q-RPT calibrations can be performed without using CalTool software (see Section 5.2.8).

5.2.1.1 PA AND PM COEFFICIENTS

The coefficients used to adjust Q-RPT readings are designated PA (an adder or offset) and PM (a multiplier or span set). The coefficients affect the Q-RPT reading following:

$$\text{Corrected reading} = (\text{uncorrected reading} \cdot \text{PM}) + \text{PA}$$

PA is expressed in units of pressure (always the SI unit, Pascal).

PM is dimensionless.

Each Q-RPT has its own unique PA and PM values. The PA and PM values currently in use can be viewed and edited from the front panel in the CAL function (see Section 5.2.7). PA and PM values are automatically edited when CalTool software results are activated.



As editing PA and PM values will change Q-RPT calibration, they should only be edited by qualified personnel as part of the calibration process. Caution should be taken to avoid accidental editing and a security system is available to prevent access (see Section 3.5.5.5). Incorrect editing of PA and PM values can cause out of tolerance measurements.



A new RPM4 is delivered with PA and PM values set to zero and 1 for all ranges. This does not mean that the RPM4 has not been calibrated. In the original factory calibration, privileged factory coefficients are used for calibration with the user PA and PM set to zero and 1.

5.2.1.2 AS RECEIVED AND AS LEFT DATA

Frequently, calibration procedures require that as received and as left data be reported. The necessary information to report as received and as left data on the calibration of RPM4 Q-RPTs can be obtained in several ways.

When the RPM4 CalTool calibration assistance software is used, as received data is displayed while running the calibration and is automatically recorded and reported if desired. As left data is also calculated and presented.

At any time, a) reference pressures applied; b) associated Q-RPT readings; c) PA and PM and P_{offset} values, can be used to calculate as received and as left values. For example, backing out PA and PM on the as left data yields the Q-RPT

readings with $PA = 0$ and $PM = 1$. Then applying the as received PA and PM and P_{offset} values to the readings calculates *as received* readings (the readings that the transducer would have made with the old PA, PM and P_{offset}).



It is recommended that “as received” values of PA, PM and P_{offset} (for Axxx Q-RPTs if absolute mode AutoZero is used in normal operation) be recorded for each Q-RPT prior to running the calibration. The current PA, PM and P_{offset} (for Axxx Q-RPTs) can be viewed by pressing [SPECIAL], <8cal>, <1view>.

5.2.2 EQUIPMENT REQUIRED



The recommended calibration standards for RPM4 Q-RPTs are DHI PG7000 piston gauges (PG7102, PG7202, PG7601 for gas; PG7302 for oil). Contact DHI for additional information.

5.2.2.1 GAS OPERATED Q-RPTS, A10M AND LOWER

Gas operated piston gauge (deadweight tester), with the following characteristics:

- **Measurement uncertainty of ± 0.0025 % of reading for Standard Class Q-RPTs or ± 0.002 % of reading for Premium Class Q-RPTs.** A standard with higher measurement uncertainty may be used but RPM4 measurement uncertainty may be degraded proportionally from published specifications.
- **If the Q-RPT is Axxx (absolute) and will be used in the absolute and/or negative gauge measurement modes, the reference must be able to apply absolute pressures:** Absolute pressures may be defined either by operation relative to an evacuated bell jar or, for higher pressures, by addition of atmospheric pressure measured by a suitable barometer. **Axxx (absolute) Q-RPTs that will not be used in absolute or negative gauge measurement modes (as is often the case for higher pressure Q-RPTs) do not require the application of absolute pressure for calibration and may be calibrated using a gauge pressure standard.**



Axxx (absolute) Q-RPTs calibrated in gauge measurement mode by applying gauge reference pressure values should be used in gauge mode only (see Sections 3.3.3, ○ PRINCIPLE, 5.2.5).

- **Able to supply the recommended sequence of pressure points in the range to be calibrated:** See Section 5.2.4 for information on the recommended calibration point sequence for various Q-RPT types and classes.

5.2.2.2 OIL OR GAS OPERATED Q-RPTS A14M AND HIGHER

Gas or oil operated piston gauge (deadweight tester), with the following characteristics:



Do not put oil or other liquids in a Q-RPT that is meant to be operated with gas.

- **Measurement uncertainty of ± 0.008 % of reading for Standard Class Q-RPTs or ± 0.005 % of reading for Premium Class Q-RPTs.** A standard with higher measurement uncertainty may be used but RPM4 measurement uncertainty may be degraded proportionally from published specifications.
- **If the Q-RPT is Axxx (absolute) and will be used in the absolute and/or negative gauge measurement modes, the reference must be able to apply absolute pressures:** Absolute pressures may be defined by adding atmospheric pressure measured by a barometer to gauge pressure defined by a piston gauge. **Axxx (absolute) Q-RPTs that will not be used in absolute or negative gauge measurement modes (as is very often the case for higher pressure Q-RPTs) do not require the application of absolute pressure for calibration and may be calibrated using a gauge pressure standard.**



Axxx (absolute) Q-RPTs calibrated in gauge measurement mode by applying gauge reference pressure values should be used in gauge mode only (see Sections 3.3.3, ○ PRINCIPLE, 5.2.5).

- **Able to supply the recommended sequence of pressure points in the range to be calibrated:** See Section 5.2.4 for information on the recommended calibration point sequence for various Q-RPT types and classes.

5.2.3 SET-UP AND PREPARATION

To set-up and prepare an RPM4 for calibration of a Q-RPT:

- ❶ Set the RPM4 on a stable surface near the calibration standard at a height as close as possible to the calibration standard's reference height. Consider the connections that may need to be made to the rear panel and access to the front panel display and keypad.
- ❷ Connect the calibration standard output to the **TEST(+)** port of the Q-RPT module to be calibrated on the RPM4 rear panel (1/8 in. NPT F or DH500F depending on range, see Section 2.3.5).
- ❸ If the Q-RPT module has a **TEST(-)** port, leave it unobstructed or connect it to the reference standard's **TEST(-)** port if available.
- ❹ Open SDS (Self Defense System) if present (see Section 3.3.8) for the Q-RPT to be calibrated. When the RPM4 indicates **<SDS CLOSED>**, the **TEST(+)** port is isolated from the Q-RPT to be calibrated.



Opening SDS with a pressure greater than Pmaxl applied to the test port may cause overpressure damage to the Q-RPT.



The Q-RPTs of RPM4s used in parallel measurement mode must be adjusted separately. PA and PM for the Hi and Lo Q-RPT need to be determined and set individually. Therefore, data to be used in determining calibration coefficients cannot be taken in parallel mode (see Section 3.5.7.3). Do not run a calibration with the HL (parallel mode) Q-RPT active.

5.2.4 RECOMMENDED CALIBRATION POINT SEQUENCE

Calibration adjustments to RPM4 Q-RPTs are made by altering calibration coefficients, PA and PM (see Section 5.2.1.1). To adjust these coefficients to optimum values giving the best results over the Q-RPTs complete operating range, specific calibration point sequences are recommended. The recommended point sequence depends upon whether the Q-RPT being calibrated is a Standard or Premium Class (see Section 1.2.2.1). The class of the RPM4 Q-RPTs is indicated in the model number on the product label and on the rear panel Q-RPT label (<s> for standard, <p> for premium, for example A7Ms or A7Mp).

Prior to running the calibration point sequence, the Q-RPT should be exercised by:

- Setting full scale pressure.
- Dwelling at full scale pressure for 5 minutes.
- Returning to atmospheric pressure (vented). If the Q-RPT is a gas operated Axxx type, use vacuum rather than atmospheric pressure.
- Dwelling for twenty minutes.

A dwell time after setting the pressure of at least 60 seconds before taking data at each point is recommended.

Section 5.2.4.1 gives calibration point sequences for Standard Class Q-RPTs and Section 5.2.4.2 gives calibration point sequences for Premium Q-RPTs.



It is not required that the calibration pressure standard apply precisely the nominal pressure value of each calibration point as long as the exact value of the applied pressure is known. Best results are obtained if the actual applied pressure is within 2 % of the recommended nominal point.

5.2.4.1 STANDARD CLASS Q-RPTS

See additional information in Section 5.2.4 concerning exercising the Q-RPT and dwell time at pressure points.

Table 22. Calibration Point Sequence, Standard Class, Axxx and Gxxx Q-RPTs

CALIBRATION SEGMENT	POINT NO.	POINT [% OF SPAN]
Ascending	1	Lowest Pressure ¹
	2	25 %
	3	50 %
	4	75 %
	5	100 %
Descending	6	75 %
	7	50 %
	8	25 %
	9	Lowest Pressure ¹

- In absolute mode, the lowest point that can be set reliably by the reference piston gauge, or atmospheric pressure for ranges > A1.4M. Zero (vented) in gauge mode.



Axxx (absolute) Q-RPTs that will NOT be used in absolute or negative gauge measurement modes may be calibrated in gauge measurement mode with a gauge pressure standard. Axxx (absolute) Q-RPTs calibrated in gauge measurement mode should be used in gauge mode only (see Sections 3.3.3, ○ PRINCIPLE, 5.2.5).

Table 23. Calibration Point Sequence, Standard Class, BGxxx Q-RPTs

CALIBRATION SEGMENT	POINT NO.	POINT [% OF SPAN] ¹
Ascending	1	0 %
	2	25 %
	3	50 %
	4	75 %
	5	100 %
Descending	6	75 %
	7	50 %
	8	25 %
	9	0 %

1. The BG15K span is - 15 to + 15 kPa, 30 kPa total. Therefore, 0 % is - 15 kPa, 25 % is - 7.5 kPa, 100 % is + 15 kPa, etc.



BGxxx (bi-directional gauge) Q-RPTs that will NOT be used in negative gauge measurement mode may be calibrated in gauge (positive pressures) measurement mode only. Use the Standard Class gauge mode (Gxxx) calibration point sequence (see Table 22). BGxxx Q-RPTs calibrated in gauge measurement mode only should not be used in negative gauge mode.

Table 24. Calibration Point Sequence, Standard Class, BA100K Q-RPT

CALIBRATION SEGMENT	POINT NO.	POINT [% OF SPAN] ¹
Ascending	1	0 %
	2	25 %
	3	50 %
	4	75 %
	5	100 %
Descending	6	75 %
	7	50 %
	8	25 %
	9	0 %

1. The BA100K span is 70 to 110 kPa absolute.

5.2.4.2 PREMIUM CLASS Q-RPTS

See additional information in Section 5.2.4 concerning exercising the Q-RPT and dwell time at pressure points.

Verification of Premium Class Q-RPTS

When verifying (as opposed to calibrating) a Premium Q-RPT, it is not necessary to include the higher density of points that is recommended for determination of the calibration coefficients. A 5 points up, 2 points down (50%, low point) run is adequate. To verify that the uncertainty turndown with AutoRange (see Sections 3.3.4, 1.2.2.1) is in tolerance, it is recommended that the verification of a Premium Q-RPT include verification of an AutoRanged span of 30 % of the maximum Q-RPT span. For example, verify an A7M Q-RPT in the default range of 0 to 7 MPa (1 000 psi) and in the AutoRange range of 2.1 MPa (300 psi).

Table 25. Calibration Point Sequence, Premium Class, Axxx and Gxxx Q-RPTs

CALIBRATION SEGMENT	POINT NO.	POINT [% OF SPAN] ¹
Ascending	1	Lowest Pressure ¹
	2	5 %
	3	10 %
	4	15 %
	5	20 %
	6	30 %
	7	40 %
	8	50 %
	9	60 %
	10	80 %
	11	100 %
Descending	12	80 %
	13	50 %
	14	20 %
	15	Lowest Pressure ¹

- ¹ In absolute mode, lowest point that can be set reliably by the reference piston gauge. Zero (vented) in gauge mode.



Axxx (absolute) Q-RPTs that will NOT be used in absolute or negative gauge measurement modes may be calibrated in gauge measurement mode with a gauge pressure standard. Axxx (absolute) Q-RPTs calibrated in gauge measurement mode should be used in gauge mode only (see Section 5.2.5).

Table 26. Calibration Point Sequence, Premium Class, BGxxx Q-RPTs

CALIBRATION SEGMENT	POINT NO.	POINT [% OF SPAN] ¹
Ascending	1	0 %
	2	15 %
	3	30 %
	4	40 %
	5	45 %
	6	50 %
	7	55 %
	8	60 %
	9	70 %
	10	85 %
	11	100 %
Descending	12	70 %
	13	50 %
	14	30 %
	15	0 %

- ¹ The BG15K span is - 15 to + 15 kPa, 30 kPa total. Therefore, 0 % is - 15 kPa, 25 % is - 7.5 kPa, 100 % is + 15 kPa, etc.



BGxxx (bi-directional gauge) Q-RPTs that will not be used in negative gauge measurement mode may be calibrated in gauge (positive pressures) measurement mode only. Use the Premium Class gauge mode (Gxxx) calibration point sequence (see Table 25). BGxxx Q-RPTs calibrated in gauge measurement mode only should not be used in negative gauge mode.

5.2.5 TURNING OFF ABSOLUTE AND NEGATIVE GAUGE MEASUREMENT MODES FOR AXXX (ABSOLUTE) Q-RPTS

○ PURPOSE

To prevent operation in absolute and negative gauge measurement modes on an Axxx (absolute) Q-RPT that has been calibrated for gauge mode only.

○ PRINCIPLE

Axxx (absolute) Q-RPTs are frequently used in gauge measurement mode only (see Section 3.3.3, ○ PRINCIPLE). Axxx Q-RPTs that are used in gauge mode only, may be calibrated in gauge mode with a reference that applies gauge pressures. Calibration with an absolute reference is not necessary. However, if an Axxx Q-RPT is calibrated in gauge mode, it is not possible to know if it is in or out of tolerance in absolute and negative gauge modes. To avoid using absolute and negative gauge measurement modes with an Axxx Q-RPT that is calibrated for gauge mode only, access to absolute and negative gauge modes can be turned OFF. This is accomplished in the [SPECIAL], <8cal> menu.

○ OPERATION



See Section 5.2.7 for more detailed information on editing and viewing Q-RPT calibration information.

Turning absolute and negative gauge mode operation ON and OFF for a Q-RPT occurs in the same area in which calibration coefficients are edited. To access the Q-RPT calibration editing area press [SPECIAL], <8cal> and select the desired Q-RPT. Then select <1edit> to make changes.

[ENT] through the calibration information screens.
After viewing the values of PA and PM the display is:

Allow abs and	HI
neg g mode?	1yes 2no

The cursor is on the number corresponding to the current selection. Make the desired selection. <1no> causes absolute and negative gauge modes to be unavailable for the Q-RPT.

5.2.6 Q-RPT CALIBRATION USING CALTOOL FOR RPTS SOFTWARE

To calibrate RPM4 Q-RPTs using CalTool software, refer to Sections 5.2.1, ○ PRINCIPLE, 5.2.2, and 5.2.3 in this manual and then refer to the CalTool for RPTs Software Manual.

CalTool for RPTs software and manual are supplied on the RPM4 General Accessories Disk and can be downloaded from www.dhstruments.com.

5.2.7 EDITING AND VIEWING Q-RPT CALIBRATION INFORMATION

○ PURPOSE

View and/or edit Q-RPT calibration information fields including:

- **The calibration date** – This field is normally used to record the date on which the Q-RPT is calibrated.
- **The value of absolute mode AutoZero P_{offset} (Axxx Q-RPTs only)** – See Section 3.5.1 for complete AutoZero information. This value is normally set to zero following absolute measurement mode calibration of an Axxx Q-RPT.
- **The value of PA** – The pressure adder for the selected Q-RPT (see Sections 5.2.1.1).
- **The value of PM** – The pressure multiplier for the selected Q-RPT (see Sections 5.2.1.1).

- **Absolute and negative gauge measurement modes ON or OFF (Axxx Q-RPTs only)**
 - See Section 3.3.3, ○ PRINCIPLE for complete information on measurement modes. This is set to OFF if an Axxx Q-RPT was calibrated in gauge mode with a gauge pressure standard.

○ OPERATION



As editing PA and PM values will change the calibration of the Q-RPTs, the edit function should only be used by qualified personnel as part of the calibration process. Caution should be taken to avoid accidental editing. A user level security system is available to control access (see Section 3.5.5.5).



A new RPM4 is delivered with PA and PM values set to zero and 1 for all ranges. This does not mean that the RPM4 has not been calibrated. In the original factory calibration, privileged factory coefficients are used for calibration with the user PA and PM set to zero and 1.

To access Q-RPT calibration information viewing or editing press **[SPECIAL]**, **<8Cal>**. Select the desired Q-RPT. The **<1view>** selection displays the calibration information fields. The **<2edit>** function displays the fields and allows them to be edited. The display is:

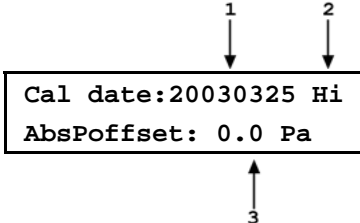
1. Date of last calibration in YYYYMMDD format.
 2. Position designator of the Q-RPT being viewed.
 3. Current value of absolute mode P_{offset} .
This line is blank if the Q-RPT is not an Axxx type.
- 

If in **edit** mode, the calibration information fields can be edited. Edits to P_{offset} are common with changes made in the AutoZ edit or run function (see Section 3.5.1). Pressing **[ENT]** on the last field goes to the next view/edit screen:

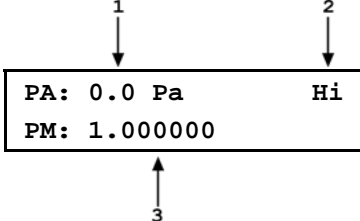
1. Value of PA.
 2. Position designator of the Q-RPT being viewed.
 3. Value of PM.
- 

If in **edit** mode, the calibration fields can be edited. If the selected Q-RPT is an Axxx Q-RPT, pressing **[ENT]** in the PM field goes to the next calibration information display (this display is skipped if the Q-RPT is a Gxxx or BGxxx type):

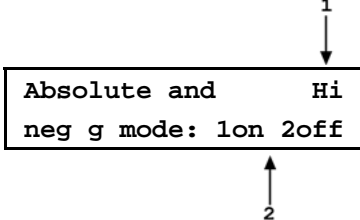
1. Position designator of the Q-RPT being viewed.
 2. Cursor is on current ON or OFF selection.
- 

The cursor is on the current setting. If in **edit** mode, the ON or OFF status can be changed by selecting **<1on>** or **<2off>** (see Section 5.2.5). **[ENT]** in view mode returns to the view/edit screen. **[ENT]** in edit mode goes to confirmation of change activation if changes have

been made in any of the calibration screens. Pressing **[ESC]** in any edit screen exits the edit screen without activating any changes.



The value of PA is always in Pascal (Pa). The value of PM is dimensionless.

5.2.8 Q-RPT CALIBRATION/ADJUSTMENT WITHOUT CALTOOL FOR RPTS SOFTWARE

○ PRINCIPLE

The RPM4 Q-RPTs can be calibrated and adjustments made without using CalTool for RPTs software. This requires:

- Applying pressures with a calibration standard and recording the pressures measured by RPM4.
- Calculating new PA and PM values and entering them.
- Setting P_{offset} to zero for Axxx Q-RPTs.



Before proceeding to calibrate a reference pressure transducer without using CalTool for RPTs software, Sections 5.2, Calibration of Reference Pressure Transducers, 5.2.1 ○ PRINCIPLE, 5.2.2 Equipment Required, 5.2.3 Setup and Preparation should be reviewed thoroughly.



The Q-RPTs of RPM4s used in parallel measurement mode must be adjusted separately. PA and PM for the Hi and Lo Q-RPT need to be determined and set individually. Therefore, data to be used in determining calibration coefficients cannot be taken in parallel mode (see Section 3.5.7.3).

○ OPERATION

The typical procedure for calibrating a Q-RPT is:

- ❶ Set-up and prepare the RPM4 for calibration (see Sections 5.2.2, 5.2.3).
- ❷ Use the **[RANGE]** function key to select the Q-RPT to be calibrated (see Section 3.3.1). Be sure to set the DF range (not an AutoRanged range).
- ❸ Use **[HEAD]** to set the HEAD to zero (see Section 3.3.7). Use **[UNIT]** to set the desired pressure unit of measure (see Section 3.3.2). Use **[MODE]** to set the desired pressure measurement mode (see Section 3.3.3). Axxx (absolute) Q-RPTs that will be used in gauge measurement mode only, may be calibrated in gauge measurement mode with a gauge pressure standard (see Section 5.2.5).
- ❹ Use **[SPECIAL]**, **<1AutoZ>** to access the AutoZ function (see Section 3.5.1).
If calibrating in absolute measurement mode, turn AutoZ ON if it is left ON in normal RPM4 operation.
If calibrating in gauge measurement mode, always turn AutoZ ON.
- ❺ Use **[SPECIAL]**, **<8cal>**, **<1Hi RPT>** or **<2Lo RPT>**, **<1view>**, to read and record the current values of PA and PM for the Q-RPT to be calibrated. If calibrating in absolute mode, also record the value of P_{offset} .

- ⑥ Run the recommended calibration point sequence for the Q-RPT (see Section 5.2.4). Record the pressure applied by the standard and the RPM4 reading at each calibration point. Dwell at least 60 seconds at each point after setting the reference pressure to allow full stabilization. The data recorded is the “as received” data for this calibration.
- ⑦ Enter the calibration pressures and RPM4 readings into a spreadsheet. Calculate the “non-corrected” RPM4 readings by backing out the PA, PM and P_{offset} (P_{offset} in the case of Axxx (absolute) Q-RPTs in absolute mode only, do not back out P_{offset} for gauge mode calibrations) recorded in Steps ⑤ and ④ above, following:

$$\text{non-corrected reading} = ((\text{corrected reading} - \text{PA})/\text{PM}) + P_{\text{offset}}$$

- ⑧ Perform a linear regression to find the offset and slope that best fit the non-corrected RPM4 readings to the calibration standard pressures. The offset is the new value of PA, the slope is the new value of PM.
- ⑨ Press [**SPECIAL**], <8Cal>, <1Hi RPT> or <2Lo RPT>, <2edit> and write the new calibration date and the new values of PA and PM for the Q-RPT calibrated (see Section 5.2.7). If this is an Axxx Q-RPT and the calibration was performed in gauge mode, turn absolute and negative gauge modes OFF to avoid their being used after the calibration.
- ⑩ Calculate as left data for the calibration if desired following:

$$\text{as left reading} = (\text{non-corrected reading} \cdot \text{new PM}) + \text{new PA}$$

- ⑪ Perform additional verification pressure runs as desired.

5.3 ADJUSTMENT OF ON-BOARD BAROMETER

○ PURPOSE

To adjust the output of the on-board barometer (see Section 1.2.2.2).



RPM4's that have only G100K or G200K Q-RPTs (no Axxx or G15K or BGxxx) are NOT equipped with an on-board barometer.

○ PRINCIPLE

The on-board barometer output can be adjusted using PA and PM values in the same manner as Q-RPTs (see Section 5.2.1.1).



The on-board barometer is a low accuracy sensor used only for measuring changes in atmospheric pressure over short periods of time (see Section 3.2.2) and the line pressure for G15KK and BG15K line pressure compensation. RPM4 measurement uncertainty does not depend on the measurement uncertainty of the on-board barometer.

○ OPERATION

To edit the values of PA and PM for the barometer, press [**SPECIAL**], <8cal>, <3barometer>. Pressing [**ENT**] steps through displays of the calibration date (YYYYMMDD) and PA and PM. In **edit** mode, the values can be edited. Pressing [**ENT**] after the last screen activates the edited values.



To view the current output of the on-board barometer, press [**SPECIAL**], <7Internal>, <3baro>.

5.4 RELOADING EMBEDDED SOFTWARE INTO FLASH MEMORY

RPM4 uses FLASH memory. This allows the embedded software that controls RPM4 operations and functions to be loaded into RPM4 over its COM1 port from a computer with a simple FLASH loading utility program.

To replace corrupted software or upgrade your software, access the **DHI** worldwide web site at **www.dhinstruments.com** and go to **SOFTWARE**. A FLASH loading utility and the latest RPM4 software are available for download at no charge. If you do not have access to the web or have difficulty downloading or loading software, contact your **DHI** representative or a **DHI** Authorized Service Provider (see Table 29) for assistance.

If you believe you have discovered an error or “bug” in RPM4 software, please report it with complete details by email to **cal.repair@dhinstruments.com** or submit an on-line **Quality Feedback Report** under **CALIBRATION & REPAIR** at **www.dhinstruments.com**.



The DHI flash software loading utility and RPM4 embedded software are available for download from www.dhinstruments.com in the SOFTWARE section.

5.5 SUBASSEMBLY DESCRIPTION AND LOCATION

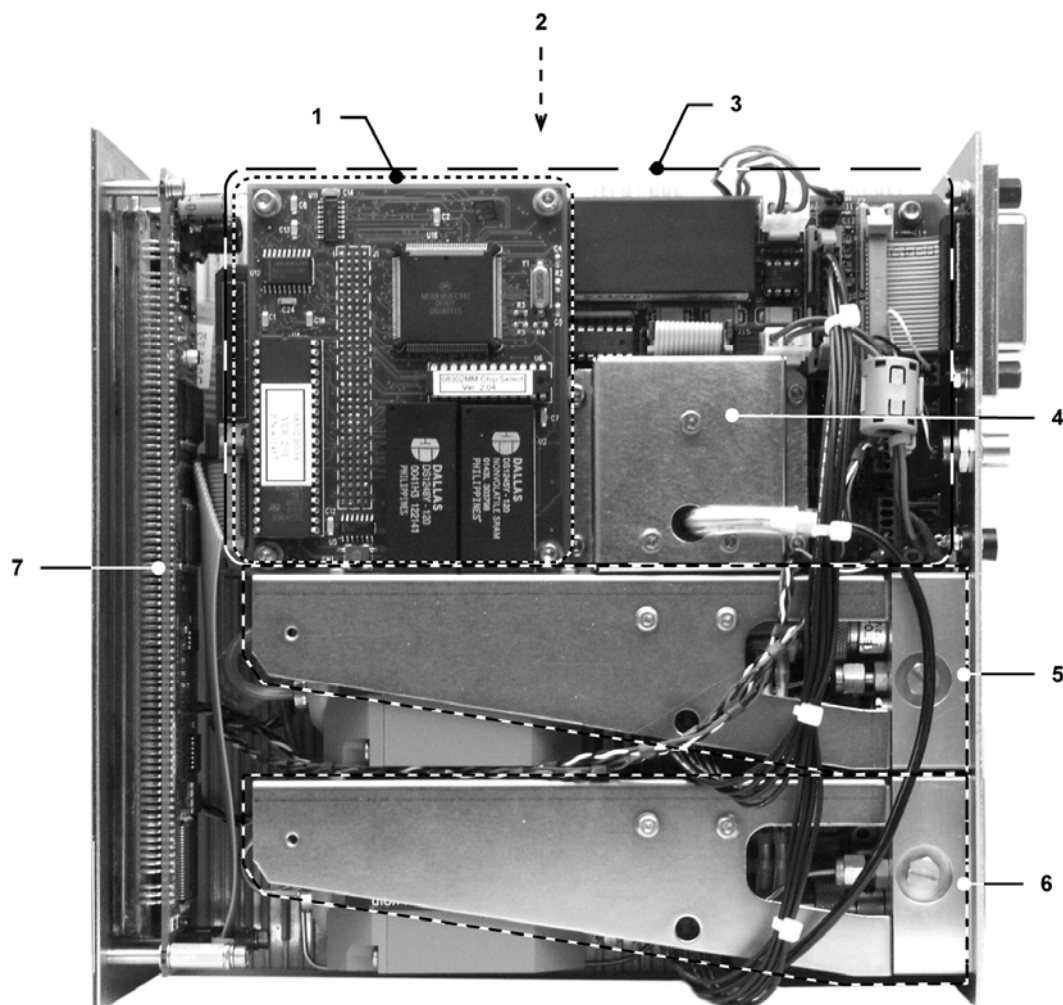

- | | | |
|--|---|--|
| 1. Micro Card | 3. Driver Board | 6. Hi Q-RPT module
($<$ A7M style shown) |
| 2. Power Supply Module
(beneath Driver Board) | 4. On-Board Barometer (if present) | 7. Display |
| | 5. Lo Q-RPT module (if present)
($<$ A7M style shown) | |

Figure 7. Internal View

5.5.1 MINI MICRO BOARD

The micro board supports a Motorola 68302 micro-controller, EPROM, EEPROM, 128k x 16 bit NVRAM, 8 Mbit flash memory; RS-232 and IEEE-488.2 communications; keypad and display control. An I/O port controls other ports and devices in RPM4.

5.5.2 POWER SUPPLY MODULE

+ 12 V DC ($\pm 2\%$) @ 2.1 Amps

5.5.3 DRIVER BOARD

The driver board is controlled by the mini micro board (see Section 5.5.1). It supports:

- 12 V drivers for internal solenoid valve actuation
- Frequency counters (2) for reading Q-RPTs (see Section 5.5.5)
- On-board barometer power and output (see Section 5.5.4)
- Utility sensor (if present) power and output
- Power to the system cooling fan
- Remote **[ENT]**
- Keypad and display
- Beeper

5.5.4 ON-BOARD BAROMETER

The on-board barometer supports a board mounted, barometric range, micromachined silicon sensor and an ambient temperature sensor. The barometer readings are used for dynamic atmospheric pressure compensation when measuring gauge pressure with an absolute quartz reference pressure transducer (see Section 3.2.2). The temperature sensor is used for temperature compensation of the barometric sensor.



RPM4s that have only G100K or G200K Q-RPTs (no Axxx or G15K or BGxxx) are NOT equipped with an on-board barometer.

5.5.5 Q-RPT MODULE

The Q-RPT module is an integrated Quartz Reference Pressure Transducer (Q-RPT) assembly. The module includes a Q-RPT, brackets to hold the transducer, interconnecting tubing, a manifold with **TEST(+)**, **TEST(-)** (A70M and lower only) and **VENT (ATM)** (A100M and higher) ports and SDS (Self Defense System) solenoid valves (A7M and lower, gas operated, only).

A Q-RPT provides very high precision, low uncertainty pressure measurement. The basic sensing principle is the measurement of the change in the natural oscillating frequency of a quartz tuning fork in response to changes in temperature and mechanical stress resulting from the change in pressure applied to a connecting bellows or bourdon tube. Two independent quartz elements are used. One quartz element is subjected to pressure related stress. The other quartz element is used only to monitor temperature. See Section 1.2.2.1 for Q-RPT specifications.

See Figure 8 for pneumatic schematics of different Q-RPT module configurations.

5.5.5.1 HI Q-RPT MODULE

RPM4 is always equipped with a Hi Q-RPT module. The Hi Q-RPT module is in the Hi Q-RPT position. It is always the higher range in two Q-RPT RPM4s.

5.5.5.2 LO Q-RPT MODULE

RPM4 may be equipped with a Lo Q-RPT module. The Lo Q-RPT provides a lower measurement range than the Hi Q-RPT. See Section 1.2.2.1 for complete Q-RPT specifications.

5.5.6 DISPLAY

2 x 20 character vacuum fluorescent display.

5.6 Q-RPT MODULE PNEUMATIC SCHEMATICS

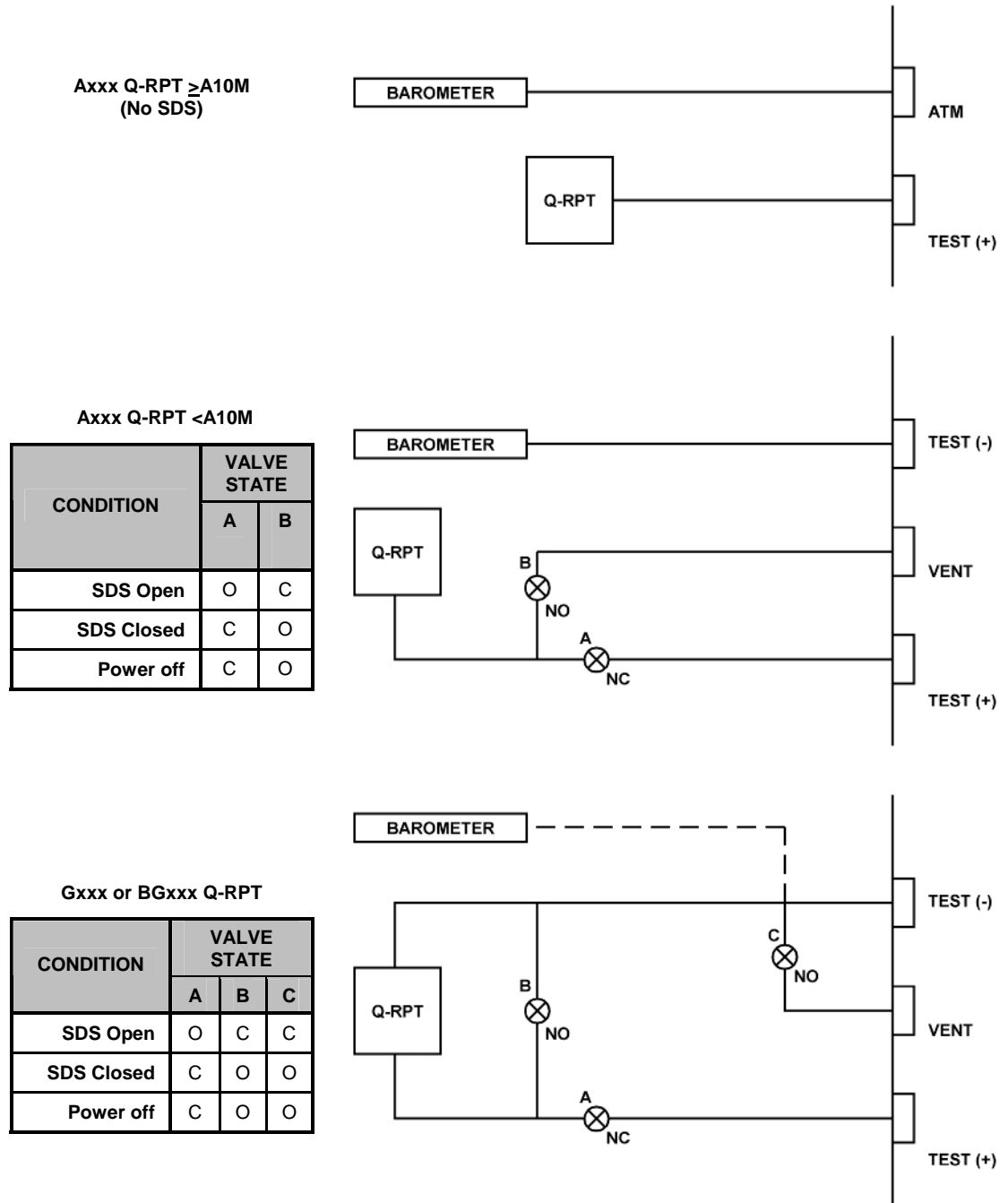

Figure 8. Pneumatic/hydraulic schematics of RPM4 with Single Q-RPT Module

The pneumatic schematic for RPM4's with two Q-RPT modules is the same as for the single Q-RPT modules in Figure 8 with the following exceptions:

- If both modules use the barometer, the barometer is connected to feed to both module barometer connection points.
- An exception is the combination of an Axxx with SDS (<A10M) and a G15K or BGxxx shown below.

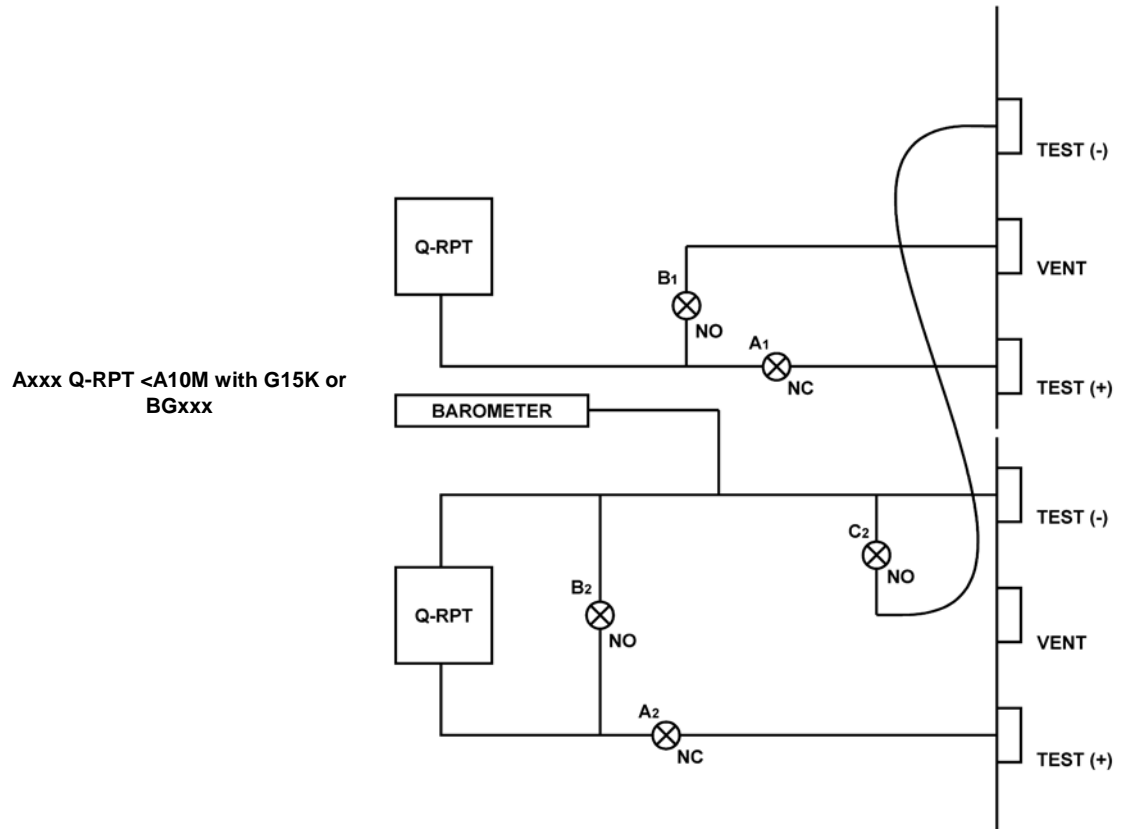

Figure 9. Pneumatic/hydraulic schematics of RPM4 with Two Q-RPT Modules



6. TROUBLESHOOTING

RPM4 is a sophisticated pressure setting and measuring instrument with advanced on-board features and functions. Before assuming that unexpected behavior is caused by a system defect or breakdown, the operator should use this manual and other training facilities to become thoroughly familiar with RPM4 operation. This troubleshooting guide is intended as an aid in identifying the reason for RPM4 behavior and determining whether the behavior is due to normal operation or an internal or external problem.

Identify the symptom or unexpected behavior you are observing from the **SYMPTOM** list below. A **PROBABLE CAUSE** is provided and a **SOLUTION** is proposed including references to manual sections that provide information that may be of assistance.

Table 27. Troubleshooting Guide

SYMPTOM	PROBABLE CAUSE	SOLUTION
Will not power up.	Blown fuse.	Replace fuse.
Cannot access certain functions > ACCESS RESTRICTED <	User level has been set that restrict access to certain functions.	Change user level or consult system manager. 3.5.5.5
Displays < FATAL ERROR > or < FATAL FAULT >.	Encountered unresolved internal software conflict.	Cycle power to clear. Please record conditions leading up to event including the numbers displayed when [ENT] is pressed and report to your DHI Authorized Service Provider. Table 29
Front panel keys seem to be disabled.	< remote > command has been sent from a host computer.	Send < local > command from host computer or cycle RPM4 power. 4, 4.4.4
Measured pressure display or other displays have too much/not enough resolution.	Resolution setting needs to be changed.	Change resolution setting. 3.4.2
Can't increase resolution to level desired in AutoRanged range.	Resolution setting is limited when AutoRanging under 10 % of Q-RPT default range.	Operation is normal. Table 6
Values that should be non-zero are displayed as zero.	Resolution setting needs to be increased to view significant digits.	Change resolution setting. 3.4.2
Keypad presses make undesired sounds or NO sounds.	Keypad sound settings are incorrect.	Use keypad function to set keypad sounds as desired. 3.5.5.2
Bottom line of display has changed and you want to change it back.	The DISPLAY function has been used to change the display.	Use [DISPLAY] to set bottom line to desired display. 3.3.6
Second line of display is < PPC3 EXT DEV:-> and front keypad is locked out.	The RPM4 has been initialized as an external device to a PPC3 pressure controller and is still in external device mode.	Cycle RPM4 power to take it out of external device mode and restore local operation. 3.2.5
Bottom line of display is blank.	DISPLAY mode is "clean".	Operation is normal. Use [DISPLAY] to change bottom line display if desired. 3.3.6
The pressure units available under the [UNIT] function key are not the ones you want.	UNIT function needs to be customized.	Use PresU function to customize the UNIT function or reset units to default. 3.5.6
Front panel display is dim.	Screen saver option has activated.	Operation is normal. Press any key to resume full screen power. Adjust screen saver time, if desired. 3.5.5.1

SYMPTOM	PROBABLE CAUSE	SOLUTION
AutoRange is not selecting the desired Q-RPT for the specified range.	The Q-RPT range does not cover the desired AutoRange.	Check that Q-RPT default range is high enough to cover the AutoRange. Table 1
	The specified operating mode is absolute or negative gauge and absolute and negative modes are OFF for the desired Q-RPT	Check that absolute/negative gauge is ON for the Q-RPT. 5.2.5
	The Q-RPT is Gxxx (gauge only) and the specified operating mode is absolute or negative gauge..	Check that the Q-RPT type supports the desired measurement mode. 3.3.3
Range will NOT change. Displays "Pressure on Hi (or Lo) RPT exceeds RR upper limit".	The pressure currently applied to the range that is being selected exceeds the UL (upper limit) set for that range.	Reduce pressure applied to test port to less than UL of target range. 3.4.4
Pressure display is flashing and beeper is sounding intermittently.	Current upper limit of active range has been exceeded.	Reduce pressure. Change UL and/or active range if needed. 3.4.4
Pressure display is flashing and beeper is sounding intermittently while operating in differential mode.	Differential pressure upper limit OR Hi Q-RPT upper limit is exceeded.	Reduce differential pressure and/or pressure on Hi Q-RPT to be less than upper limit values or change upper limit value(s). 3.4.4, 3.3.3.1
Pressure display is NOT flashing and beeper is sounding intermittently while operating in differential mode.	Lo Q-RPT upper limit is exceeded. If Lo Q-RPT is displayed on second line, its measured pressures is flashing.	Reduce pressure on Lo Q-RPT or change its upper limit. 3.4.4, 3.3.3.1
"Hi (or Lo) RPT EXCEEDED PMAX" displays alternating with normal display.	RPM4 Q-RPT has been overpressured (Pmax! exceeded).	Correct the overpressure condition and cycle power ON and OFF to clear. 3.4.4.1
Rapid beeping for 8 seconds and <Check RPT connection> displayed in second line.	RPM4 is in parallel measurement mode and the disagreement in pressure measured by the two Q-RPTs indicates they may not be connected in parallel.	If parallel measurement mode is not desired, change ranges or turn it off. If parallel measurement is desired, check that the Hi and Lo Q-RPTs are connected to the same pressure. Ignore if having the two Q-RPTs on two different pressures is intentional. 3.5.7.3
A <i>Ready</i> (green <i>Ready/Not Ready</i> indicator) indication is never achieved.	Stability settings is too tight and/or existing conditions will not allow <i>Ready</i> to be achieved.	Adjust stability setting or correct other conditions. 3.4.3, 3.2.1
Cannot select absolute or negative gauge measurement mode.	Q-RPT is Gxxx and does not support absolute and gauge measurement modes or	Operation is normal. 3.3.3
Cannot select differential measurement mode.	RPM4 must have two Q-RPTs of the same type (Axxx, Gxxx, BGxxx) and the current range must be the default range (<DF>) of the Hi Q-RPT for differential measurement mode to be available.	If RPM4 has two Q-RPTs of the same type, set the default range of the Hi Q-RPT. 3.3.3.1
Q-RPT is Axxx (absolute) but cannot select absolute or negative gauge measurement mode.	Absolute and negative gauge measurement mode have been turned off in the calibration function.	Check that absolute/negative gauge is ON for the Q-RPT. 5.2.5
Display update rate of indicated pressure changes when changing pressure.	RPM4 automated read rate function is ON to automatically adjust read rate depending upon rate of change of pressure.	Operation is normal. Turn automated read rate function OFF if desired. 3.5.7.2
Pressure is changing but display of pressure is NOT and the bottom right hand corner of the display is a numerical countdown followed by <avg> .	Average DISPLAY function is ON and pressure display is updating only with the average value at the end of each averaging cycle.	Go to a DISPLAY function other than average or press [+/-] to get the instantaneous value Average DISPLAY. 3.3.6
Display update of indicated pressure is too slow when pressure is changing quickly.	RPM4 automated read rate function is OFF.	Turn automated read rate function ON to automatically adjust read rate depending on pressure rate of change. 3.5.7.2
Pressure measurement seems erratic when measuring gas pressure.	The RPM4 and/or the connection to the test system is contaminated with liquids.	Purge and clean affected systems. Contact DHI Authorized Service Provider if RPM4 is contaminated internally. Table 29
Pressure indicated by RPM4 never becomes stable.	These is a leak in the pressure system to which RPM4 is connected.	Find and correct leak. Consider using RPM4 leak check function. 3.3.5

SYMPTOM	PROBABLE CAUSE	SOLUTION
Disagreement between two Q-RPTs in system appears excessive.	Difference is actually within tolerance and acceptable disagreement.	Compare differences observed to tolerances on Q-RPT measurements. 1.2.2.1
Apparent inaccurate pressure control/measure and little or no response from Q-RPT:	Reference transducer destroyed by overpressure.	Contact DHI Authorized Service Provider. Table 29
Apparent inaccurate pressure measurement.	Incorrect pressure units and/or measurement mode (gauge or absolute).	Set desired pressure units and/or measurement mode. Consider reference temperature if unit is in Wa. 3.3.2, 3.3.3
	Q-RPT calibration coefficients have been altered.	Check and correct calibration coefficients if needed. 5.2
	AutoZ has been run and turned ON with an incorrect standard for zero.	Check value of P _{offset} . Rerun AutoZ with a valid reference. 3.5.1
Apparent inaccurate pressure measurement and <h> is displayed on top line of screen.	An unplanned "head" correction is active or head height or fluid is incorrect.	Operation is normal. Remove or change "head" correction. 3.3.7
Pressure applied is zero gauge but reading is NOT zero.	Need to run AutoZ to rezero in gauge mode.	Run AutoZ. 3.3.9
	Current measurement mode is absolute and RPM4 is indicating atmospheric pressure.	Check measurement mode setting and set to gauge if gauge pressure measurements are desired. 3.3.3
Pressure applied is atmospheric but RPM4 indicates near zero.	Current measurement mode is gauge and RPM4 is indicating zero gauge pressure.	Operation is normal. Check measurement mode setting and set to absolute if absolute pressure measurements are desired. 3.3.3
A third Q-RPT designated HL is available but RPM4 has only two Q-RPTs.	Parallel measurement mode has been activated.	Operation is normal. Turn off parallel measurement mode if desired. 3.5.7.3
NOT reading pressure applied to the test port and <SDS CLOSED> is flashing over the pressure indication.	SDS is CLOSED for the active Q-RPT so the pressure applied to the test port is NOT getting to the Q-RPT.	After taking precautions to assure that pressure applied to test port is safe for the RPT, OPEN SDS. 3.2.7, 3.3.8
Is NOT reading pressure applied to the TEST(+) port.	RPM4 may have two TEST(+) ports and the pressure to be measured is connected to the wrong Q-RPT's port	Familiarize yourself with your RPM4 configuration. Connect pressure to be measured to correct TEST(+) port. 2.3.5, 5.6
	RPM4 may have two TEST(+) ports and pressure to be measured is connected to correct port but active Q-RPT is NOT the Q-RPT on that TEST port.	Familiarize yourself with your RPM4 configuration. Select active range to be on the Q-RPT to which the pressure to be measured is corrected. 5.6, 3.3.1
<SDS CLOSED> is displayed alternating with the measured pressure.	SDS is CLOSED for the active Q-RPT.	Operation is normal. OPEN SDS if desired. 3.3.8
SDS should be present on a Q-RPT but does not seem to be active.	SDS has been turned full time OFF for the Q-RPT.	Turn SDS full time ON. 3.5.4.2
SDS will not OPEN for the Q-RPT shown on the second line in the Q-RPT DISPLAY function.	When not in differential or parallel measurement mode, SDS on the inactive Q-RPT can only be OPENED using direct SDS control.	Use direct SDS direct control to OPEN SDS on the inactive Q-RPT. 3.5.4.1
SDS was left OPEN on one Q-RPT when ranges were changed. When you come back to it, its CLOSED again.	When changing ranges causes a change of the active Q-RPT, SDS is always CLOSED for the Q-RPT that becomes inactive.	Operation is normal. 3.2.7
You would like to eliminate the SDS function for a Q-RPT.	Set SDS to be inactive except for an overpressure situation.	Turn SDS full time OFF for the Q-RPT. 3.5.4.2

NOTES

7. APPENDIX

7.1 REMOTE [ENT]

The RPM4 remote ENTER function operates by detecting the open or closed status of the REMOTE ENTER switch.

The normal status of the ENTER switch is OPEN. When RPM4 detects a CLOSED condition held for 300 ms, it is interpreted as equivalent to a press of the **[ENT]** key.

Any switch may be used to accomplish the remote ENTER function. The switch should be installed on the optional remote ENTER cable (**DHI** P/N 103128). Install the switch by connecting its two terminals to the black and white wires of the remote ENTER cable.

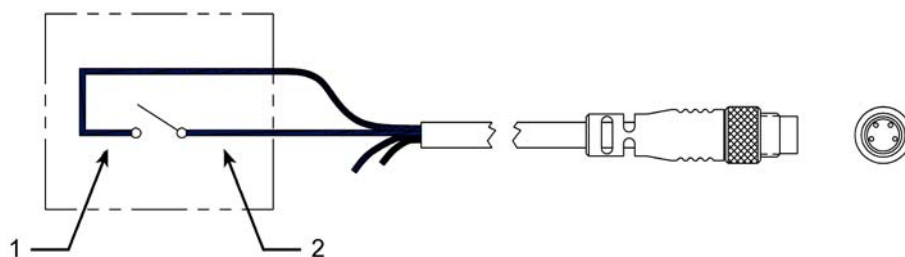

Figure 10. Remote [ENT] Connector Schematic

1. Black wire 2. White wire

7.2 UNIT CONVERSION

7.2.1 PRESSURE

RPM4 performs all internal calculations in SI units. Numerical values input or output in other units are converted to SI immediately after entry and back to other units just before output as needed.

Table 28 provides the conversion coefficients used by RPM4 to convert numerical values expressed in SI units to corresponding values expressed in other units.

Table 28. Pressure Unit of Measure Conversion Coefficients

TO CONVERT FROM Pa To		MULTIPLY BY
Pa	<i>Pascal</i>	1.0
mbar	<i>millibar</i>	1.0 E-02
hPa	<i>hecto Pascal</i>	1.0 E-02
kPa	<i>kilo Pascal</i>	1.0 E-03
bar	<i>Bar</i>	1.0 E-05
mmWa @ 4°C	<i>millimeter of water</i>	1.019716 E-01
mmHg @ 0°C	<i>millimeter of mercury</i>	7.50063 E-03
psi	<i>pound per square inch</i>	1.450377 E-04
psf	<i>pound per square foot</i>	1.007206 E-06
inWa @ 4°C	<i>inch of water</i>	4.014649 E-03
inWa @ 20°C	<i>inch of water</i>	4.021732 E-03
inWa @ 60°F	<i>inch of water</i>	4.018429 E-03
inHg @ 0°C	<i>inch of mercury</i>	2.953 E-04
kcm ²	<i>kilogram force per centimeter square</i>	1.019716 E-05
mTorr	<i>milliTorr (micron of mercury)</i>	7.50063
Torr	<i>Torr (millimeter of mercury)</i>	7.50063 E-3
user	<i>User</i>	User defined coefficient
Ft	<i>feet of altitude</i>	see Altitude Note below
M	<i>meter of altitude</i>	see Altitude Note below

Altitude Note: Quantities expressed in units of altitude follow MIL-STD-859A “Static Pressure, p, in Inches of Mercury for Values of Pressure Altitude, H, in Geopotential Feet.” MIL-STD-859A provides tables of pressure in inches of mercury as a function of altitude in feet. RPM4 uses a set of equations to model the pressure/altitude relationship. The worst case deviation between the MIL-STD-859A table and the calculated pressure is 0.0001 inches of mercury (0.3 Pa). The pressure quantity expressed in inches of mercury is converted to Pascal following Table 28 above. For altitude expressed in meters, meters are converted to feet using 1 m = 3.28084 ft.



8. WARRANTY

8.1 OVERVIEW

Except to the extent limited or otherwise provided herein, **DH Instruments, a Fluke Company** warrants for one year from purchase, each new product sold by it or one of its authorized distributors, only against defects in workmanship and/or materials under normal service and use. Products which have been changed or altered in any manner from their original design, or which are improperly or defectively installed, serviced or used are not covered by this warranty.

DH Instruments and any of its Authorized Service Providers' obligations with respect to this warranty are limited to the repair or replacement of defective products after their inspection and verification of such defects. All products to be considered for repair or replacement are to be returned to **DH Instruments** or its Authorized Service Provider after receiving authorization from **DH Instruments** or its Authorized Service Provider. The purchaser assumes all liability vis a vis third parties in respect of its acts or omissions involving use of the products. In no event shall **DH Instruments** be liable to purchaser for any unforeseeable or indirect damage, it being expressly stated that, for the purpose of this warranty, such indirect damage includes, but is not limited to, loss of production, profits, revenue, or goodwill, even if **DH Instruments** has been advised of the possibility thereof, and regardless of whether such products are used individually or as components in other products.

The provisions of this warranty and limitation may not be modified in any respect except in writing signed by a duly authorized officer of **DH Instruments**.

The above warranty and the obligations and liability of **DH Instruments, a Fluke Company** and its Authorized Service Providers exclude any other warranties or liabilities of any kind.

Table 29. DHI Authorized Service Providers

DH INSTRUMENTS, A FLUKE COMPANY AUTHORIZED SERVICE PROVIDERS			
COMPANY	ADDRESS	TELEPHONE, FAX & EMAIL	NORMAL SUPPORT REGION
DH Instruments, a Fluke Company	4765 East Beautiful Lane Phoenix AZ 85044-5318 USA	Tel 602.431.9100 Fax 602.431.9559 cal.repair@dhinstruments.com	Worldwide
Minerva Meettechniek B.V.	Chrysantstraat 1 3812 WX Amersfoort the NETHERLANDS	Tel (+31) 33.46.22.000 Fax (+31) 33.46.22.218 info@minervaipm.com	European Union
Ohte Giken, Inc. Technology Center	258-1, Nakadai Kasumigaura-machi, Niihari-Gun, Ibaraki 300-0133	Tel 81/29.840.9111 Fax 81/29.840.9100 tech@ohtegiken.co.jp	Japan/Asia
DH Products Technical Service Division	National Institute of Metrology Heat Division Pressure & Vacuum Lab NO. 18, Bei San Huan Donglu Beijing 100013 PR CHINA	Tel 010.64291994 ext 5 Tel 010.64218637 ext 5 Fax 010.64218703 cxcen@mx.cei.gov.cn	Peoples Republic of China

NOTES



9. GLOSSARY

Axxx	A type of Q-RPT with a built-in vacuum reference that is intrinsically absolute (e.g. A10M). Axxx Q-RPTs support absolute, gauge and negative gauge measurement modes.
Absolute Mode	Measurement mode in which the Q-RPT indicates absolute pressure (difference from vacuum).
Active Q-RPT	The Q-RPT that is currently selected to be displayed on the top line of the RPM4 display. Most function selections affect the active Q-RPT.
AutoRange	A function that optimizes RPM4 measurement and control for a specific, user defined range of operation.
AutoRanged Range	An RPM4 pressure measurement range created using the AutoRange function.
AutoTest or ATest	RPM4 on-board automated testing sequences and their results.
AutoZero or AutoZ	A process by which a Q-RPT and measurement mode is zeroed (offset) relative to a standard.
Barometer	RPM4's on-board atmospheric pressure measuring sensor. Also referred to as on-board barometer.
BGxxx	A type of Q-RPT that is intrinsically gauge and is capable of operating bi-directionally, above and below atmosphere, through zero. BGxxx Q-RPTs support gauge and negative gauge measurement modes.
Default Range (DF)	A Q-RPT's maximum range that is always available using [RANGE] and cannot be deleted.
Deviation	A DISPLAY function in which the deviation of the current pressure from a target pressure is displayed.
DUT	Device Under Test. The device or devices pneumatically connected to the RPM4 TEST(+) port that the RPM4 is being used to test or calibrate.
Differential mode	Measurement mode in which the measured pressure is the different between the Hi and Lo Q-RPT (Hi – Lo).
FS	Abbreviation of "full scale". The full scale value is the maximum pressure of a measurement range. Limits and specifications are often expressed as % FS. Also see span.
Gxxx	A type of Q-RPT that is intrinsically gauge but only measures pressure greater than atmosphere. Gxxx Q-RPTs support gauge measurement mode only.
Gauge Mode	Measurement mode in which the Q-RPT indicates gauge pressure (difference from atmospheric pressure), but only in the positive direction (above atmosphere).
Head	A difference in height between the RPM4 reference level and the DUT.
HiLo	A DISPLAY function in which the highest and lowest pressure measurements since reset are recorded and displayed.
Hi Q-RPT	The designation of a single Q-RPT in an RPM4, or, if there are two, the one that has the highest full scale default range.
HL Q-RPT	The designation of the pseudo Q-RPT that results from the combination of using two Q-RPTs simultaneously in parallel measurement mode.
Inactive Q-RPT	In an RPM4 with two Q-RPTs, the Q-RPT that is not currently displayed on the top line of the display. The inactive Q-RPT may be displayed on the second line of the RPM4 display using the RPT DISPLAY function.
Lo Q-RPT	The designation of a the Q-RPT with the lower full scale default range in RPM4s with two Q-RPTs.
Measurement Mode	Whether pressure is being measured relative to absolute zero or vacuum (absolute mode) or relative to atmospheric pressure (gauge mode).
Negative gauge or compound gauge	Measurement mode in which the Q-RPT indicates gauge pressure (difference from atmospheric pressure), in both positive and negative directions (above and below atmosphere).
P_{offset}	The difference between a Q-RPT reading and the AutoZero reference at the time AutoZ is run. Used by the AutoZ function when Auto Z is ON to compensate Q-RPT readings for changes in zero over time.
P_{std,0}	AutoZero reference value. Value indicated by the device against which the Q-RPT is zeroed by AutoZ.
PA	Pressure adder, used to offset a Q-RPT or barometer to calibrate it.

PM	Pressure multiplier, used to adjust span of a Q-RPT or barometer to calibrate it.
Parallel Measurement Mode	Operating mode of RPM4s with two Q-RPTs in which both Q-RPTs are used to measure together in parallel and the indicated pressure is the average of their readings. This creates a pseudo Q-RPT designated HL.
Pmax!	The maximum pressure limit of a Q-RPT. If the pressure measured by the Q-RPT exceeds Pmax!, an overpressure condition occurs.
PPC3	Pressure controller calibrator manufactured by DHI . RPM4 can be used as an external reference device for a PPC3. PPC3 automates RPM4 pressure control.
Q-RPT (Quartz Reference Pressure Transducer)	The transducer used by RPM4 for low uncertainty pressure measurement. May be designated as Hi, Lo or HL depending on its position and role in the RPM4. Q-RPTs are designated by a leading A, G or BG (absolute, gauge or bi-directional gauge) followed by three numbers and a letter indicating the maximum range of the Q-RPT in kPa (nnnK) or MPa (nnnM).
Rate	A DISPLAY function in which the rate of change of pressure in pressure unit/second is displayed.
Ready/Not Ready	Front panel LED indication of when the pressure measured by RPM4's active Q-RPT is stable within the stability limit. Leading character of the second line when the inactive Q-RPT is displayed on the second line in RPT DISPLAY mode.
RPT2x	Parallel measurement mode in which both Q-RPTs of an RPM4 with two Q-RPTs are used together and the indicated pressure is the average of their measurements.
SDS (Self Defense System)	A system to protect Q-RPTs from overpressure made up of isolation and vent valves and internal operating logic. Applies only to Q-RPTs designated A7M or lower.
Span	The difference between FS and the lowest point in a range. For example, the span of a 100 kPa FS range in negative gauge mode is nominally 200 kPa (from - 100 kPa to 100 kPa).
Stability Limit	A limit expressed in units of pressure per second (e.g., kPa/second). The stability limit is used as the <i>Ready/Not Ready</i> criterion. <i>Ready</i> if rate of change is less than stability limit. <i>Not Ready</i> if rate of change is greater than stability limit.
Target	The value from which deviations are measured in the Deviation DISPLAY function.
UL (Upper Limit)	A user settable maximum pressure limit. When pressure exceeds UL, RPM4 beeps intermittently. In negative gauge measurement mode, there is also a user settable lower limit.
User Level	Levels of security that can be set to protect certain RPM4 functions from being accessed.
QDUT	On-board automated test sequence that AutoRanges RPM4 based on characteristics of the Device Under Test (DUT).