

2700G

Reference Pressure Gauge

Calibration Manual

September 2013

© 2013 Fluke Corporation. All rights reserved. Specifications are subject to change without notice.
All product names are trademarks of their respective companies.

LIMITED WARRANTY AND LIMITATION OF LIABILITY

Each Fluke product is warranted to be free from defects in material and workmanship under normal use and service. The warranty period is one year and begins on the date of shipment. Parts, product repairs, and services are warranted for 90 days. This warranty extends only to the original buyer or end-user customer of a Fluke authorized reseller, and does not apply to fuses, disposable batteries, or to any product which, in Fluke's opinion, has been misused, altered, neglected, contaminated, or damaged by accident or abnormal conditions of operation or handling. Fluke warrants that software will operate substantially in accordance with its functional specifications for 90 days and that it has been properly recorded on non-defective media. Fluke does not warrant that software will be error free or operate without interruption.

Fluke authorized resellers shall extend this warranty on new and unused products to end-user customers only but have no authority to extend a greater or different warranty on behalf of Fluke. Warranty support is available only if product is purchased through a Fluke authorized sales outlet or Buyer has paid the applicable international price. Fluke reserves the right to invoice Buyer for importation costs of repair/replacement parts when product purchased in one country is submitted for repair in another country. Fluke's warranty obligation is limited, at Fluke's option, to refund of the purchase price, free of charge repair, or replacement of a defective product which is returned to a Fluke authorized service center within the warranty period.

To obtain warranty service, contact your nearest Fluke authorized service center to obtain return authorization information, then send the product to that service center, with a description of the difficulty, postage and insurance prepaid (FOB Destination). Fluke assumes no risk for damage in transit. Following warranty repair, the product will be returned to Buyer, transportation prepaid (FOB Destination). If Fluke determines that failure was caused by neglect, misuse, contamination, alteration, accident, or abnormal condition of operation or handling, including overvoltage failures caused by use outside the product's specified rating, or normal wear and tear of mechanical components, Fluke will provide an estimate of repair costs and obtain authorization before commencing the work. Following repair, the product will be returned to the Buyer transportation prepaid and the Buyer will be billed for the repair and return transportation charges (FOB Shipping Point).

THIS WARRANTY IS BUYER'S SOLE AND EXCLUSIVE REMEDY AND IS IN LIEU OF ALL OTHER WARRANTIES, EXPRESS OR IMPLIED, INCLUDING BUT NOT LIMITED TO ANY IMPLIED WARRANTY OF MERCHANTABILITY OR FITNESS FOR A PARTICULAR PURPOSE. FLUKE SHALL NOT BE LIABLE FOR ANY SPECIAL, INDIRECT, INCIDENTAL, OR CONSEQUENTIAL DAMAGES OR LOSSES, INCLUDING LOSS OF DATA, ARISING FROM ANY CAUSE OR THEORY.

Since some countries or states do not allow limitation of the term of an implied warranty, or exclusion or limitation of incidental or consequential damages, the limitations and exclusions of this warranty may not apply to every buyer. If any provision of this Warranty is held invalid or unenforceable by a court or other decision-maker of competent jurisdiction, such holding will not affect the validity or enforceability of any other provision.

Fluke Corporation
P.O. Box 9090
Everett, WA 98206-9090
U.S.A.

Fluke Europe B.V.
P.O. Box 1186
5602 BD Eindhoven
The Netherlands

Table of Contents

Title	Page
Introduction.....	1
Contact Fluke Calibration.....	1
Standard Equipment.....	2
Safety Information.....	2
Symbols.....	3
Maintenance.....	4
Clean the Product.....	4
Change the Batteries.....	4
Specifications.....	6
Accuracy.....	6
Media Compatibility.....	6
Environmental Specifications.....	6
Mechanical Specifications.....	6
Available Pressure Ranges.....	7
Necessary Equipment.....	7
Calibration Tests.....	8
Connections.....	8
Initiate Communication.....	8
Calibration Steps.....	9
Serial Point Adjustment.....	9
Set Zero.....	9
Set Span.....	9
Save.....	10
User-Replaceable Parts.....	10

List of Tables

Table	Title	Page
1.	Symbols.....	3
2.	Necessary Calibration Equipment.....	7
3.	Calibration Tests	9
4.	User-Replaceable Parts	10

List of Figures

Figure	Title	Page
1.	Change the Batteries.....	5
2.	Terminal Settings	8

Introduction

The 2700G Series Reference Pressure Gauges (the Product) are high-accuracy digital pressure test gauges. Accurate to 0.02 % FS, the Product can be used as a calibration reference or in applications where high-accuracy pressure measurement is necessary.

The Product features user-configurable functions that include:

- Sampling rate
- Tare
- Damping
- Auto off
- Min Max

Contact Fluke Calibration

To contact Fluke Calibration, call one of the following telephone numbers:

- Technical Support USA: 1-877-355-3225
- Calibration/Repair USA: 1-877-355-3225
- Canada: 1-800-36-FLUKE (1-800-363-5853)
- Europe: +31-40-2675-200
- Japan: +81-3-6714-3114
- Singapore: +65-6799-5566
- China: +86-400-810-3435
- Brazil: +55-11-3759-7600
- Anywhere in the world: +1-425-446-6110

To see product information and download manuals and the latest manual supplements, visit Fluke Calibration's website at www.flukecal.com.

To register your product, visit <http://flukecal.com/register-product>

Standard Equipment

The Product ships with:

- Protective cover (installed)
- Three AA alkaline batteries (installed)
- 2700G Safety Information (printed)
- Report of calibration
- Manuals CD-ROM with translated users manuals
- USB cable
- USB power adapter
- NPT to ¼ BSP male adapter
- NPT to M20 x 1.5 male adapter

Safety Information

A **Warning** identifies conditions and procedures that are dangerous to the user. A **Caution** identifies conditions and procedures that can cause damage to the Product or the equipment under test.

Warning

To prevent injury, only assemble and operate high-pressure systems if you know the correct safety procedures. High-pressure liquids and gases are hazardous and the energy from them can be released without warning.

To prevent possible electrical shock, fire, or personal injury:

- **Read all safety Information before you use the Product.**
- **Use the Product only as specified, or the protection supplied by the Product can be compromised.**
- **Do not use the Product around explosive gas, vapor, or in damp or wet environments.**
- **Do not use and disable the Product if it is damaged.**
- **Remove the batteries if the Product is not used for an extended period of time, or if stored in temperatures above 50 °C. If the batteries are not removed, battery leakage can damage the Product.**
- **Replace the batteries when the low battery indicator shows to prevent incorrect measurements.**
- **The battery door must be closed and locked before you operate the Product.**

⚠ Caution







To prevent possible damage to Product or to equipment under test:

- The display reads “OL” when the pressure source is above the Product range limit. The pressure source must immediately be removed.
- Do not apply more than the maximum torque specified. Maximum torque specified is 20 Nm = 15 ft-lb.

Symbols

Symbols used on the Product and in this manual are in Table 1.

Table 1. Symbols

Symbol	Meaning	Symbol	Meaning
	Risk of danger. Important information. See manual.		Conforms to European Union directives.
	Hazardous voltage. Risk of electrical shock.		Conforms to relevant North American Safety Standards.
	Conforms to relevant Australian standards.		This product complies with the WEEE Directive (2002/96/EC) marking requirements. The affixed label indicates that you must not discard this electrical/electronic product in domestic household waste. Product Category: With reference to the equipment types in the WEEE Directive Annex I, this product is classed as category 9 "Monitoring and Control Instrumentation" product. Do not dispose of this product as unsorted municipal waste. Go to Fluke's website for recycling information.

Maintenance

Clean the Product

Clean the Product with a soft cloth dampened with water or water and weak soap.

⚠ Caution

To prevent possible damage to the Product, do not use solvents or abrasive cleansers.

⚠ Caution

For safe operation and maintenance of the product:

- **Repair the Product before use if the battery leaks.**
- **Remove batteries to prevent battery leakage and damage to the Product if it is not used for an extended period.**
- **Be sure that the battery polarity is correct to prevent battery leakage.**
- **Have an approved technician repair the Product.**

Change the Batteries

⚠⚠ Warning

To prevent possible electrical shock, fire, or personal injury, have an approved technician repair the Product.

To change the batteries, see Figure 1:

1. Pull off the Product cover.
2. Use a Phillips screwdriver to loosen the captive screw on the battery door.
3. Remove the battery door.
4. Replace the three AA batteries, note the correct polarity.
5. Install the battery door again.
6. Tighten the captive screw.
7. Put the Product cover back on.

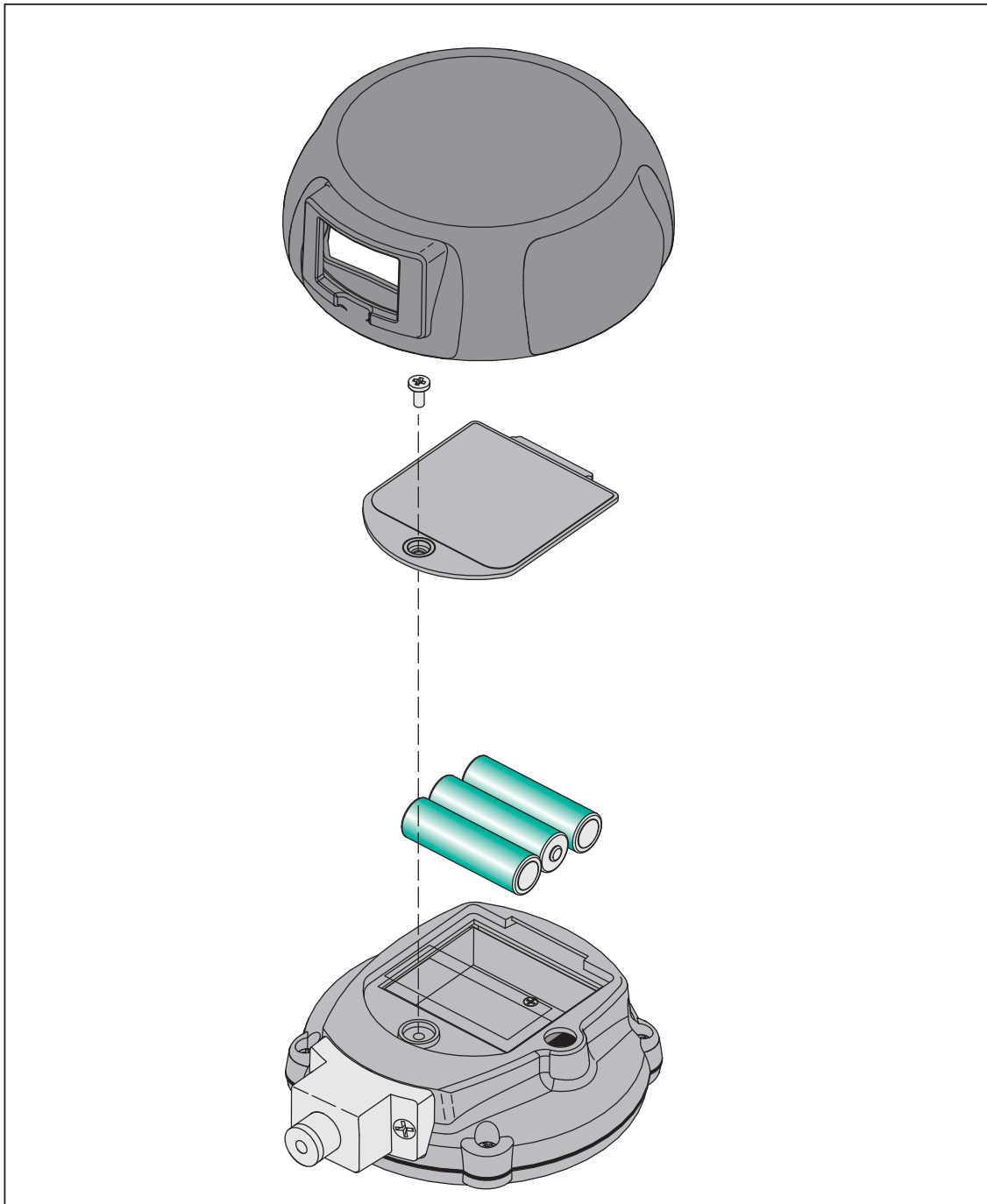

Figure 1. Change the Batteries

gsn002.eps

Specifications

Instrumental Measurement Uncertainty

Positive Pressure	±0.02 % FS
Vacuum	±0.05 % FS
Temperature Compensation.....	18 °C to 28 °C (65 °F to 82 °F) to rated accuracy



Note

For temperatures from 0 °C to 18 °C and 28 °C to 50 °C, add
.003 % FS/°C

Media Compatibility

15, 30 psi.....	any clean dry non-corrosive gas
100, 300, 500, 1000 psi.....	any liquids or gases compatible with 316 stainless steel
Above 1000 psi.....	any non-flammable, non-toxic, non-explosive, non-oxidizing liquid or gas compatible with 316 stainless steel.

Environmental Specifications

Operating Temperature	0 °C to 50 °C (32 °F to 122 °F)
Storage	-20 °C to +70 °C (-4 °F to +158 °F)
Humidity	10 % to 90 % RH Non-condensing
Altitude	2000 m (6561.68 ft)
Pollution Degree	2
Agency Approvals	CE,  , 

Mechanical Specifications

Dimensions	(11.4 x 12.7) cm, depth = 3.7 cm (4.5 x 5) in, depth = 1.5 in (Without protective cover)
Pressure	
Connection	¼ in NPT male
Housing	Cast ZNAl
Display.....	5-1/2 Digits, 16.53 mm (0.65 in) high 20-Segment bar graph, 0 to 100 %
Power	
Battery	three size AA alkaline batteries
Battery Life	75 hours typical without backlight

Available Pressure Ranges

Model Number	2700G-BG100K	2700G - BG200K	2700G - BG700K ^[1]	2700G - BG2M ^[1]	2700G - BG3.5M ^[1]	2700G - BG7M ^[1]	2700G - G20M ^[1]	2700G - G35M ^[1]	2700G - G70M ^[1]
Pressure Range (psi)	15	30	100	300	500	1000	3000	5000	10000
Pressure Range (MPa)	0.1	0.2	0.7	2	3.5	7	20	35	70
Vacuum Range (psi)	-15	-15	-12	-12	-12	-12	0	0	0
Vacuum Range (kPa)	-100	-100	-80	-80	-80	-80	0	0	0
Burst Pressure (psi)	45	90	1000	2000	2000	10000	10000	10000	15000
Burst Pressure (MPa)	0.3	0.6	7	14	14	70	70	70	100
Proof Pressure (psi)	30	60	200	600	1000	2000	6000	8000	13000
Proof Pressure (MPa)	0.2	0.4	1.4	4	7	14	40	55	90

[1] Measuring or calibrating below -12 psi will invalidate the pressure measurement specification.

Necessary Equipment

Pressure and/or vacuum standards that can produce and show pressures from vacuum to the full-scale range of the unit under test (UUT) are necessary for calibration and adjustment. To maintain the specified Product accuracy, use a pressure standard with an uncertainty of $\pm 0.0075\%$ FS of the Product or lower. The necessary equipment for the calibration procedures is shown in Table 2.

Table 2. Necessary Calibration Equipment

Model Name	Range	Recommended Model Pressure Calibrator	Minimum Specification
2700G-BG100K	-15 psi to 15 psi (-100 kPa to 100 kPa)	PG7601 or 2465	± 0.0011 psi (± 0.0075 kPa)
2700G-BG200K	-15 psi to 30 psi (-100 kPa to 200 kPa)	PG7601 or 2465	± 0.0023 psi (± 0.015 kPa)
2700G-BG700K	-15 psi to 100 psi (-100 kPa to 700 kPa)	PG7601 or 2465	± 0.008 psi (± 0.0525 kPa)
2700G-BG2M	-15 psi to 300 psi (-100 kPa to 2000 kPa)	PG7601 or 2465	± 0.023 psi (± 0.15 kPa)
2700G-BG3.5M	-15 to 500 psi (-100 to 3500 kPa)	PG7601 or 2465	± 0.04 psi (± 0.2625 kPa)
2700G-BG7M	-15 psi to 1000 psi (-100 kPa to 7000 kPa)	PG7601 or 2465	± 0.08 psi (± 0.525 kPa)
2700G-G20M	0 psi to 3000 psi (0 kPa to 20000 kPa)	PG7202	± 0.23 psi (± 1.5 kPa)
2700G-G35M	0 psi to 5000 psi (0 kPa to 35000 kPa)	PG7202	± 0.4 psi (± 2.625 kPa)
2700G-G70M	0 psi to 10000 psi (0 psi to 70000 kPa)	PG7202	± 0.8 psi (± 5.25 kPa)

Calibration Tests

Calibration verifies the complete operation of the Product and measures the accuracy of each function against Product specifications. If the Product fails a part of the test, adjustment or repair is necessary. See “Serial Point Adjustment”.

It is recommended that you apply full-scale pressure to the Product and then vent before calibration adjustment. Let the Product stabilize for 1 minute after venting before continued testing.

Note

Calibration and adjustment can be performed anywhere in the operating ambient temperature range of 18 °C to 28 °C (64 °F to 82 °F). Calibration or adjustment outside this temperature range will invalidate the compensation program in the Product. For optimum results, the calibration or adjustment should be done with ambient temperature as close as possible to 23 °C (72 °F).

Connections

The Product uses a ¼ inch NPT male connection in the pressure input port. Adapters may be necessary to connect to the pressure standard. Make sure the hose, tubing, and fittings have a rated working pressure at or above the pressure of the unit. Make sure there are no leaks when you do the calibration process. Use Teflon tape where necessary.

Initiate Communication

Serial communications can be set up with terminal communication software on a PC, such as Windows HyperTerminal.

1. Connect the USB RS232 cable to the serial jack on the rear of the Product.
2. Connect the other end of the cable to the PC. Terminal settings are shown in Figure 2.

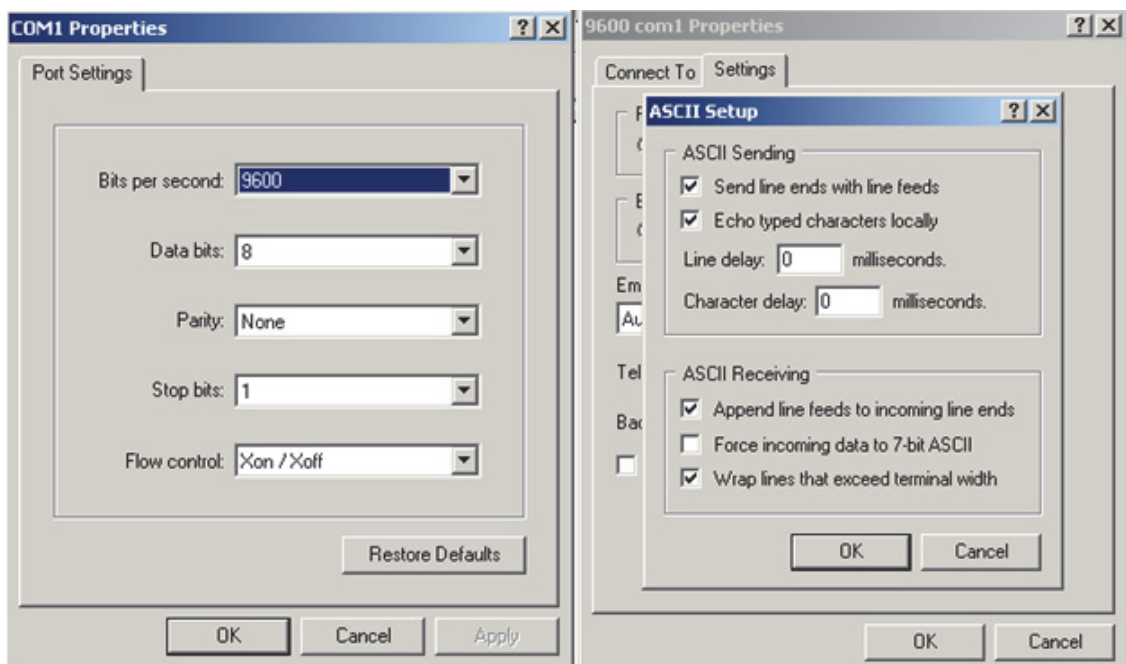

Figure 2. Terminal Settings

hmc001.bmp

Calibration Steps

To calibrate the Product, apply the values shown in Table 3 for the correct Product. If the Product fails to show the correct indication, adjustment is necessary. Calibration can be done in any pressure unit that can be shown on the Product display. Pressure units of psi and kPa are shown in Table 3 as examples. If calibrating in other units, use points that are as close as possible to those in Table 3.

Table 3. Calibration Tests

Model	Calibration Points (psi)	Calibration Points (kPa)
2700G-BG100K	0, -6, -12, -3, 0, 0, 3, 6, 9, 12, 15	0, -40, -80, -20, 0, 0, 20, 40, 60, 80, 100
2700G-BG200K	0, -6, -12, -3, 0, 0, 6, 12, 18, 24, 30	0, -40, -80, -20, 0, 0, 40, 80, 120, 160, 200
2700G-BG700K	0, -6, -12, -3, 0, 0, 20, 40, 60, 80, 100	0, -40, -80, -20, 0, 0, 140, 280, 420, 560, 700
2700G-BG2M	0, -6, -12, -3, 0, 0, 60, 120, 180, 240, 300	0, -40, -80, -20, 0, 0, 400, 800, 1200, 1600, 2000
2700G-BG3.5M	0, -6, -12, -3, 0, 0, 100, 200, 300, 400, 500	0, -40, -80, -20, 0, 0, 700, 1400, 2100, 2800, 3500
2700G-BG7M	0, -6, -12, -3, 0, 0, 200, 400, 600, 800, 1000	0, -40, -80, -20, 0, 0, 1400, 2800, 4200, 5600, 7000
2700G-G20M	0, 600, 1200, 1800, 2400, 3000	0, 4000, 8000, 12000, 16000, 20000
2700G-G35M	0, 1000, 2000, 3000, 4000, 5000	0, 7000, 14000, 21000, 28000, 35000
2700G-G70M	0, 2000, 4000, 6000, 8000, 10000	0, 14000, 28000, 42000, 56000, 70000

Serial Point Adjustment

Adjustment of the Product is done electronically with internal software. It is not necessary to open the Product case. All calibration commands and adjustments are done through the serial port connection. If the processes in the next sections do not bring the Product into specification, then it will be necessary to send your Product to Fluke Calibration for calibration adjustment.

Set Zero

After all connections are made, vent the Product to atmosphere and send this command:

OFFSET_ADJ?

Note the value that is shown. When the pressure is stable, send:

OFFSET_ADJ N

N is the pressure given from the previous OFFSET_ADJ? command.

Set Span

Send the GAIN_ADJ? command.

Note the value shown. Use the correct pressure standard to input a value equal to or near the noted value. When pressure is stable, send:

GAIN_ADJ N

N is the entered pressure.

Two-point calibration is complete.

Save

Push the power button to save the calibration adjustment.

Note

When you calibrate the Product, the results should typically be within 50 % of the total uncertainty. For calibration with the serial port, use the VAL? command. A typical calibration is to be done at 20 % increments first with ascending pressure and then with descending pressures. The typical procedure for vacuum calibration is to be done in this order:

-6 psi, -12 psi, -3 psi and back to 0 psi.

User-Replaceable Parts

User-replaceable parts are shown in Table 4. For more information about these items and their prices, contact a Fluke Calibration representative. See the “Contact Fluke Calibration” section.

Table 4. User-Replaceable Parts

Description	Fluke Part Number
Gauge Cover	4201079
2700G-8004 DECAL BG100K 15PSI 0.1MPA	4201101
2700G-8005 DECAL BG200K 30PSI 0.2MPA	4201112
2700G-8006 DECAL BG700K 100PSI 0.7MPA	4201120
2700G-8007 DECAL BG2M 300PSI 2MPA	4201135
2700G-8008 DECAL BG3.5M 500PSI 3.5MPA	4201147
2700G-8009 DECAL BG7M 1000PSI 7MPA	4201158
2700G-8010 DECAL G20M 3000PSI 20MPA	4201164
2700G-8011 DECAL G35M 5000PSI 35MPA	4201173
2700G-8012 DECAL G70M 10000PSI 70MPA	4201186
POWER SUPPLY, SW, 5W, 85-264VAC, 5 V@1 A, 3 KV, W/MAINS ADAPTERS, USB OUT, UNIV, WALL MOUNT	4252495
USB CABLE, USB TO RS232, 1.8M/5V WIRE END W/ CONN, 4 CONTACT, F CBL W/STRAIN RLF	4258329
2700G Manuals CD	4150074
AA Alkaline batteries, NEDA 15A IEC LR6	376756